

The passage below contains blank spaces numbered 1 to 15. For each blank space choose the correct answer to fill in the blank spaces.

Honesty, as the wise saying 1 , is the best policy. It is important that we form a 2 of always speaking the truth. Irrespective 3 the situation we 4 in. Being assertive and standing 5 ground is another social value we 6 learn. Apologise if 7 be but never be tempted to 8 a lie. Lying will only make others 9 confidence 10 you. Once 11 is lost, relationships are broken 12 they can never be 13 . Life without friends becomes very 14 . Let us all learn to speak the truth and it shall 15 us free.

- | A          | B      | C       | D       |
|------------|--------|---------|---------|
| 1. comes   | goes   | says    | speaks  |
| 2. manner  | habit  | like    | talk    |
| 3. for     | on     | at      | of      |
| 4. are     | was    | were    | came    |
| 5. out     | onto   | our     | upon    |
| 6. would   | could  | should  | might   |
| 7. would   | need   | shall   | wanted  |
| 8. say     | tell   | speak   | want    |
| 9. bring   | feel   | lose    | give    |
| 10. for    | on     | of      | in      |
| 11. yours  | theirs | trust   | bright  |
| 12. and    | down   | but     | away    |
| 13. mended | built  | worked  | brought |
| 14. boring | happy  | pleased | fan     |
| 15. bring  | save   | set     | take    |

For question 16 to 18 choose the BEST answer to fill the sentences below.

16. The monkey tail was cut escaped narrowly.  
 A. whom B. whose  
 C. which D. who
17. The teacher gave the pupils newspapers to read.  
 A. a few B. a few  
 C. a D. an
18. My elder sister finally after spending many years abroad.  
 A. got up  
 B. got back  
 C. got off  
 D. got down

For questions 19 to 21, choose the BEST word to replace the underlined words from the alternatives provided.

19. There was a surprise attack as the bank was about to close.  
 A. theft B. robber  
 C. raid D. gang

20. The leopard killed the hog which was in the pig's house.

- A. nest B. stable  
 C. sty D. den

21. Nyakang'a bent down her head because of shame.

- A. combed B. headed  
 C. shaved D. drooped

In question 22 and 23, provide the correct question tags.

22. Wabora shouted at Meki, \_\_\_\_\_ ?  
 A. wasn't it B. isn't it  
 C. don't he D. didn't he

23. My money is missing, \_\_\_\_\_ ?  
 A. is it B. wasn't it  
 C. was it D. isn't it

In question 24 and 25, choose the word that LEAST fits in each group.

24. A. nest B. lair  
 C. shelf D. shell

25. A. eel B. wine  
 C. vinegar D. milk

**READ THE FOLLOWING PASSAGE AND ANSWER QUESTIONS THAT FOLLOW**

Long ago the hare, the hyena and the dog used to live as great friends. Even other animals would always shudder with amazement how these three animals could be so friendly and yet very different from each other!

Then one day the hyena was invited for a party by his in-laws. And like a good friend, he decided to ask his friends to accompany him to his in-laws for the feast. The friends on their part did not disappoint him and they agreed to offer company.

The hyena and his friends were given a reception of the highest degree one could expect from in-laws. They were treated to a great feast. They ate and drank to their fill. They danced and got the best possible entertainment. It was really an entertaining visit; a very colourful entertainment!

When darkness came and it was already night time, the hyena and his friends were shown where to sleep. This was in the same room where sheep and goats were kept. But the greedy hyena could not be trusted! In the thick of the night, all the animals were deeply asleep except the hyena. The greedy hyena could not control his hunger. He kept yawning and swallowing the saliva of a glutton and glancing at the sheep near him. He stealthily walked to one ram and held it by the throat so as to not make noise and awaken the friends. Very quickly the hyena strangled and ate the ram. Then he smeared blood on the lips of his friends carefully and then went to sleep as if nothing had happened. But the hyena's tricks did not work quite well. His friends licked their lips while still in sleep and they became as clean as they had been before.

When the hyena's father-in-law went to check his flock, he discovered that one ram was missing. He at once asked his guest to explain who was responsible for the ungrateful act. Nobody answered. Perhaps the matter would have ended unresolved. But the hare thought it was a good chance for him to trick down the thief. So he called the hyena's father-in-law and whispered for a little while. Then the hyena's in-law rushed out. No sooner had he left than he reappeared. He returned, brandishing a panga in hand and shouting viciously. "I have discovered the thief who killed my ram and I am going to teach him a lesson. I will slash and crush him like flour."

The hyena was already trembling with fear and trying hard not to show it. He was panic-stricken. Then, suddenly, the dog dashed out and ran as fast as his legs could carry him with thin sweat dripping out of his body. The hyena burst out into a loud laughter which reached the dog's ears. This laughter made the dog confirm his fears that the hare had actually blamed him for the offence. That is why to this day the dog and the hare do not see eye to eye.

26. The word shudder has been underlined, which of the words provided has the same in meaning?
- A. worry
  - B. shock
  - C. shaken
  - D. terrible
27. From the passage we learn that \_\_\_\_\_
- A. the hare, the hyena and the dog lived in amazement.
  - B. the hare, the hyena and the dog lived harmoniously.
  - C. the other animals envied their shudder with amazement.
  - D. the other animals wanted to join the hare, hyena and dog.
28. According to the passage, it is TRUE to say that \_\_\_\_\_
- A. The hyena was accompanied by his friends.
  - B. The hare requested his friends to accompany him.
  - C. The dog was accompanied by his friends.
  - D. The in-laws accompanied their friends.
29. The hyena and his friends were given an exceptional reception because \_\_\_\_\_
- A. Hyena demanded for that kind of reception.
  - B. Hyena and his friends needed such a reception.
  - C. In-laws had to give such a reception.
  - D. In-laws demanded such a reception.

30. It is FALSE to state that \_\_\_\_\_
- the hyena and his friends were great heroes.
  - the in-laws were very generous.
  - the hare and the dog accompanied the hyena.
  - the friends did not disappoint the hyena.
31. At the end of the feast they \_\_\_\_\_
- were given a reception of the highest degree.
  - ate and drank to their fill.
  - strangled and ate a ram.
  - were shown where to put up.
32. The hyena could not sleep because he was \_\_\_\_\_
- sleepless.
  - yawning.
  - angry.
  - greedy.
33. Before he killed the ram, he made sure that \_\_\_\_\_
- all and sundry were asleep.
  - all the sheep were asleep.
  - everybody was out of sight.
  - not a soul was around.
34. But the hyenas 'trick' refer to the \_\_\_\_\_
- licking blood.
  - blood on the lips.
  - eating the ram.
  - missing ram.
35. When the hyena's friends wake up, they \_\_\_\_\_
- had no blood on their lips.
  - had some blood on their lips.
  - were very hungry.
  - were very angry.
36. Who suffered for no good reason?
- The hyena.
  - The dog.
  - The hare.
  - The friends.
37. According to the passage, it is TRUE to state that \_\_\_\_\_
- the dog ate the ram.
  - the hare ate the ram.
  - the hare knew the thief.
  - the dog did not eat the ram.
38. The BEST title for this passage is?
- friend in need is a friend in deed.
  - Trustworthy friends.
  - Unfaithful friend.
  - The best friends.

**READ THE FOLLOWING PASSAGE AND ANSWER QUESTIONS THAT FOLLOW**

Many people treat their bodies in the same way. It is easy to remember to eat enough to satisfy hunger, just as it is easy to remember to put petrol in a car. But it is often forgotten that body building foods (proteins) and foods to keep the body healthy (vitamins and mineral salts) are also needed to keep the vital parts in good working order. Such foods are important for children especially when they are growing fast.

A new born baby should have the mother's milk. This means that the mother must eat plenty of good food to have sufficient milk. She should also drink a lot of milk, water and fruit juices, but not too much tea or coffee. If she does not have enough milk, she should go to the hospital or a health centre to learn the proper way of mixing milk with sugar and water for the baby to take.

The feeding of a baby requires special care. For example one should never feed a baby with the bottle without proper advice from qualified people. In addition, we should ensure that babies get proper food. Drinks like tea and squash are not good for babies.

Even when a baby is breast - feeding, he must learn to feed at regular times. Some people mistakenly think that a baby cries just because he is hungry. There are many things which make a baby cry; his clothes may be wet or he may be uncomfortable and want to be turned over. Most common of all, he may have wind in his stomach. When a baby sucks, he sucks milk and wind, so that his stomach is full of milk as well as wind. If you do not get the wind out after a feed, he will become uncomfortable and soon begin to cry. When you have

finished feeding him, pat him gently on the back to make him release some of the wind through the mouth. Then he will sleep peacefully.

39. According to the first paragraph we should eat enough to?
- A. be like fuelled car
  - B. satisfy hunger
  - C. in order to grow fast
  - D. to keep the vital parts in good working order
40. When children are growing fast it is very important for them to \_\_\_\_\_
- A. satisfy hunger and thirst
  - B. take only body-building foods
  - C. take the right variety of food
  - D. take the correct amount of starch
41. A new born baby means:-
- A. a mother`s first child
  - B. a clean fresh baby
  - C. the last born in a family
  - D. a baby that has just been born
42. Feeding a baby at regular times means?
- A. feeding him frequently
  - B. feeding him for a given time
  - C. feeding him at definite time
  - D. feeding him when he has cried
43. Which of the following best explains why babies cry?
- A. being hungry or uncomfortable
  - B. having wind or being wet
  - C. being fed irregularly
  - D. wanting to be turned over
44. Which of the following should a mother take caution when taking?
- A. water
  - B. fruit juice
  - C. coffee
  - D. milk
45. Which is the opposite of the word in bold in the story?
- A. discomfort
  - B. Comfortable
  - C. comfort
  - D. smart
46. Besides sucking milk, the baby sucks....
- A. water
  - B. tea
  - C. coffee
  - D. wind
47. The following are said not to be good for babies except \_\_\_\_\_
- A. milk
  - B. tea
  - C. Coffee
  - D. Squash
48. Why should a mother visit a hospital or a health centre according to the passage?
- A. to take a child to clinic
  - B. to learn the proper way of mixing milk with sugar and water for the baby to take
  - C. to learn the proper way of mixing milk with sugar and water to take
  - D. to be given advice on proper diet
49. The phrase `in addition` as used in the passage can be replaced with:-
- A. beside
  - B. however
  - C. although
  - D. besides
50. The best summary of this passage would be?
- A. breast feeding
  - B. balanced diet
  - C. health and hygiene
  - D. a mother`s diet

Kutoka swali la 1-15, chagua jibu linalofaa zaidi kujaza nafasi

Msimu 1 mvua 2 , sote tulielekea mgundani tukiwa na 3 za mahindi tulizopewa na shirika 4 la kimataifa. 5 ulianza mara moja kwa kuwa 6 yalikuwa yamechimbwa hapo 7 8 Mvua ya manyunyumanyunyuu ilikuwa ikiendelea kunyea, hatukulegeza kamba kwa kuamini kuwa 9

- |   |                               |                                 |                                   |
|---|-------------------------------|---------------------------------|-----------------------------------|
| 1. A. ya                                | B. la                         | C. kwa                          | D. wa                             |
| 2. A. ulipokuja                         | B. ilipowadia                 | C. ulipowadia                   | D. ilipokuja                      |
| 3. A. mimea                             | B. mbegu                      | C. kande                        | D. miche                          |
| 4. A. moja                              | B. limoja                     | C. mmoja                        | D. kimoja                         |
| 5. A. upandi                            | B. Uvunaji                    | C. Upanzi                       | D. Upaliliaji                     |
| 6. A. mshimo                            | B. matuta                     | C. makoongo                     | D. mbonji                         |
| 7. A. jana                              | B. awali                      | C. msimuni                      | D. majirani                       |
| 8. A. lwapo                             | B. Ikiwa                      | C. Pindi                        | D. Ingawa                         |
| 9. A. ukipanda pakwisha utavuna patosha | B. fuata nyuki ukafe mzingani | C. mkokoto wa jembe si bure yao | D. akufaaye kwa dhik ndiye rafiki |

10 ya watoto wanaotoka 11 12 maskini ni jambo la kuhuzunisha sana. 13 kuwanyima haki zao na 14 , jamii inatakiwa kuyakimu mahitaji yao ya kimsingi. Ni kinyume cha sheria kuwatesa na 15 Wana wakembe.

- |                     |                 |                  |                 |
|---------------------|-----------------|------------------|-----------------|
| 10. A. maonevu      | B. dhalimu      | C. maaafa        | D. uonevu       |
| 11. A. kwenye       | B. katika       | C. na            | D. kwa          |
| 12. A. jamaa        | B. sehemu       | C. aila          | D. eneo         |
| 13. A. Kabla ya     | B. Baada ya     | C. Punde tu      | D. Badala ya    |
| 14. A. kuwathamini  | B. kuwaponza    | C. kuwadhamini   | D. kuwadhulumu  |
| 15. A. kuwatekeleza | B. kuwatelekeza | C. kuwatendekeza | D. kuwateketeza |

Kuanzia swali la 16-30, jibu kulingana na maagizo

16. Fadhiha ni mtoto wa mjomba wangu ananiita \_\_\_\_\_  
A. mkoi B. mpwa  
C. halati D. mjukuu
17. Tegua kitendawili hiki: nyumbani kwetu watu wote wana vilemba vyeusi  
A. njiti za kiberiti  
B. nywele za kichwani  
C. vijinga vya kuni  
D. masizi kwenye chungu
18. Jaza pengo kwa kiulizi mwafaka. Ni askari aliyewatia mbaroni majambazi?  
A. ngapi B. nani  
C. gani D. mgani
19. Akifisha sentensi ifuatayo vilivyo: Ghulamu huyu ni mbumbumbu hambiliki hasemekiki  
A. ? B. ;  
C. . D. :

20. Chagua sentensi iliyo na -po- ya wakati  
A. Panapofaa kufagiwa ni safi  
B. Kanisa litajengwa palipo na mto  
C. Hapo ndipo pao akina Rozi  
D. Nilimwona alipokuwa akisoma
21. Masomo ya alasi huanza saa nane kasorobo. Kwa tarakimu ni saa  
A.2:15 B.7:45  
C.1:45 D.8:15
22. Maneno masaibu, mashaibu na masahibu yote ni :  
A. vitate B. vitawe  
C. visawe D. vitenzi
23. Chagua neno baki kati ya haya uliyopewa:  
A. iliki  
B. kunde  
C. dania  
D. nyanya

24. Teua kinyume cha: Bibi arusi alilakiwa jioni.  
A. Bwana arusi alilakiwa asubuhi.  
B. Bibi arusi aliondoka asubuhi  
C. Bwana arusi alisindikizwa asubuhi  
D. Bwana arusi aliagwa asubuhi
25. Ni jōzi ipi iliyo na kiumbe na makao yake halisi?  
A. Buu – Mzinga  
B. Buibui- utando  
C. Mbuni-Kiota  
D. Bata- zizi
26. Chagua sentensi isiyo sahihi kisarufi.  
A. Miezi hayo yote ina siku thelathini  
B. Maradhi ya UKIMWI ni janga kubwa  
C. Sabuni hiyo inatoa povu jingi  
D. Mifugo wote ni wa mzee Makuu
27. Neno moyo katika hali ya udogo ni  
A. Kimoyo  
B. Kijimoyo  
C. Kijijoyo  
D. Kijoyo
28. Andika kwa wingi : Ufito uliotumiwa kujengea ni wako  
A. Ufito uliotumiwa kujengea ni wenu  
B. Fito yaliyotumiwa kujengea ni yenu  
C. Fito zilizotumiwa kujengea ni zenu  
D. Fito iliyotumiwa kujengea ni yenu
29. Bainisha maneno yaliyopigiwa mstari:  
La kufa halisikii dawa wala kafara.  
A. Kivumishi, kielezi  
B. Kitenzi, kihusishi  
C. Kibadala, sifa  
D. Kiwakilishi, Kiunganishi
30. Changua sentensi iliyo na kwa ya kihusishi  
A. Mkutano wa siasa ulihudhuriwa na wazee kwa vijana  
B. Tutaenda kwa bibi yetu kumjulia hali joini hii  
C. Ofisini kwake kuna panya wanaoguguna karatasi  
D. Mgonjwa anapewa dawa chungu kwa kijiko kidogo

**Soma ufahamu ufahamu ufuatao kisha ujibu maswali 31-40**

Maisha ya Mkota yalikuwa magumu na ya kazi za mtulinga. Alikuwa mkokota mkokoteni mitaani. Aliwabebea akina mamanitilie bidhaa zao walizouza magengeni na wakati mwingine aliyauza maji yasiyojulikana alikochota. Aidha, alibebeshwa takataka za gulioni alizotupa ovyo kwenye mitaro ya maji na ushorobani usiku watu wakiwa wamelala.

Ilikuwa dhahiri shahiri kwamba alikuwa mja mchafu kama kilihafu. Isitoshe, alikuwa mchafuzi mazingira nambari moja bila kuona soni wala kuaibika. Japo aliyachuuza maji, hakuwahi kukoga kwa muda mrefu. Uchafu wa jasho la kila uchao na mavumbi ulimganda ukawa ngozi ya pili ya mwili wake. Alinuka kama fondogoo. Mngepitana na msukuma rukwama huyo kibeberu kingekupiga puani nusura uzimie.

Lebasi zake ambazo daima hazikufuliwa zilikuwa ngumu kama ngozi ya ng'ombe iliyokaushwa. Jeshi la nzi lilimwandama popote alipokwenda kama walinda usalama wake. **Aliwakodisha makao chawa** waliofurahia hali ile kwa ajili ya kazi yake nzito alikuwa wa mataluma manne, hali iliyomfanya kuwa na maungo ya kuwahifadhi vimelea kwa mamia.

Jambo la aibu ni kuwa alikuwa akijikunakuna ovyo ovyo kila sehemu hadharani. Wenzake walisinyika na tabia hiyo ikabidi wamkalie kigwena na kumpangia njama. Aha! Chake kikawekwa motoni bila yeye kujua. "Angewaibisha hivyo mpaka lini?" walisemezana huku wakinung'unika.

Mwia si mwia, mpango uliiva na muda kutimia. Adhuhuri hiyo akiwa katika pilkapilka zake za kawaida alishtukia amezingirwa na barobaro huku wakiimba nyimbo za kumsuta na kumkashifu. Alinyanyuliwa halambe halumbe kwa mikono iliyozoea shughuli ngumungumu. Naam, mwenye nguvu mpishe.

Mbele yake paliwekwa mkokoteni. Alivuliwa nguo zote. Alifululizwa hadi mtoni umbali wa kilomita tatu. Aliogeshwa na kupigwa brashi huku umati ukishangilia kuona sinema ya bwerere. **Walisikika wakiamba kuwa siku ya nyani kufa miti yote huteleza.**

31. Ni wazi kuwa Mkota alifanya vibarua vyake:  
A. Mtaani B. sokoni  
C. mjini D. kijijini
32. Kisawe cha ushorobani ni:  
A. barabarani B. ghurufani  
C. handakini D. kichochoroni
33. Maisha ya Mkota yalikuwa magumu madhali alifanya kazi za mtulinga. Maana ya maneno haya ni:  
A. Alikuwa akifanya kazi ngumu  
B. Alibeba bidhaa nyingi na nzito  
C. Hakupenda kuzifanya kazi hizo  
D. Aliteseka kwa kukosa malipo
34. Uchafu aliokuwa nao barobaro huyu unaweza kuitwa:  
A. kutuzi B. matongo  
C. koga D. jasho
35. "Dhahiri shahiri..." Fani hii imetumiwa katika aya ya pili inaitwa:  
A. tashbihi B. tashtiti  
C. tanakili D. takriri
36. Mwandishi anaarifu kuwa:  
A. Waliomwogeshwa Mkota ni vijana wa mtaani  
B. Maadui walimdhulumu Mkota kwa kumvua nguo  
C. Ghulamu wa magengeni walipenda ushushi  
D. Mkota alifanya kazi na watu waliomwogeshwa
37. Chagua jambo lisilo la kweli kwa mujibu wa makala haya:  
A. Biashara ilikuwa imenoga siku ya kuogeshwa  
B. Mkota alisalimu amri ya vijana kwa urahisi  
C. Wauzaji maji magengeni walikuwa wanaume kwa wanawake  
D. Wanunuzi pamoja na wateja walijababika vitushi
38. Kwa nini Mkota alipangiwa njama?  
A. Alikuwa amewaadhi watu  
B. Alimkanyaga mwenzake  
C. Aliwakalia wenzake kingwena  
D. Hakuwa na maji ya kukoga
39. Usemi "Aliwakodesha makao chawa" Unamaanisha nini?  
A. Aliandamwa na chawa  
B. Alifurahia chawa  
C. Chawa walimfyonza damu  
D. Ilimgharimu kuwa na chawa
40. Methali inayokaribiana kimaana na "Siku ya nyani kufa miti yote huteleza ni:  
A. Muungwana akivuliwa nguo huchutama  
B. Kila mwamba ngoma ngozi huivuta kwake  
C. Siku uendayo uchi ndiyo utakutana na mkweo  
D. Mti mkuu ukigwa wana wa ndege wa mashakani

**Soma ufahamu ufuatao kisha ujibu swali la 41-50**

Maliasili ni vitu kama vile madini, misitu na maji. Maliasili hupatikana katika mandhari na huleta natija sufufu katika jamii yetu. Ni zawadi ya kipekee kutoka kwake Mola na inayohitaji kutunzwa kwa makini.

Madini hutuletea darahima za kigeni. Hela hizi hutumiwa kudumisha uchumi wetu. Uchumi unapoimarika serikali huweza kugharamia maendeleo mbalimbali kama vile kukarabati baraste na kutengeneza nyingine mpya hasa katika maeneo ya mashambani ambapo usafiri wa barabarani hutatizwa na kukosekana kwa barabara zenye lami. Hospitali pia hujengwa na wagonjwa huweza kupata huduma.

Madini yayo hayo, huwezesha ukuzi wa viwanda ambavyo hutengenezewa vidhaa mbalimbali. Fauka ya hayo wakenya hupata kazi katika viwanda hivyo na wengi wao hujiendeleza kiuchumi. Vijana ambao huonekana kama pakashume mitaani huweza kuachana na gange mbi na kushiriki katika ujenzi wa taifa. Kwa kweli kazi mbi si mchezo mwema. Hakuna faida ya vijana kukaa ovyo huku wakitumia dawa za kulevya. Wanapopata ajira wao huwacha kuwa kupe kwa jamii zao.

Misitu huvuta mvua. Mvua husababisha unawiri wa mimea mashambani. Wakulima hupata mavuno kochokocho. Kilimo kinapoboreka jamii hupata vyakula vya kutosha na uchumi

huinuka. Karatasi tunazoandikia hutengenezwa kwa kutumia miti. Wanyamapori huishi kwenye misitu. Watalii wanapoizuru nchi yetu, kivutio kikubwa zaidi huwa ni wanyamapori. Kuna umuhimu wa kuyatunza mazingira yetu. Miti haifai kukatwa ovyoovyo. Umesikia mwito kuwa ukikata mti mmoja panda miwili au zaidi. Misitu ndiyo yenye chemichemi nyingi za mito. Nchi isiyo na miti huwa jangwa: Ardhi iliyokumbwa na ukame kwa muda mrefu huonekana kama kaka tupu la yai. Ni vyema tutahadhari kabla ya hatari.

Maji nayo yana manufaa chungu nzima. Usafi wote wa nyumbani hutegemea maji. Bila maji hakuna usafi kabisa. Watu watanuka fe! Kama mizoga kutokana na uchafu. Pahali penye uchafu huwa na vimelea ambao husababisha maradhi. Asilimia sabini ya mwili wa binadamu ni maji. Bila maji mja hana maisha kabisa. Zaidi ya hayo, kemikali za viwandani huchanganywa kwa kutumia maji. Ujenzi wa nyumba unahitaji mwashi atumie maji kuchanganya saruji na kokoto.

Kwa hakika maliasili ni hidaya ambayo Jalali ametujalia. Tuitunze kwa hali na mali. Tuitumie kwa uangalifu sana ili izidi kuyafaidi maslahi yetu.

41. Gani si natija ya maliasili?
  - A. Ujenzi wa barabara
  - B. Kuwepo kwa misitu
  - C. Kustawi kwa uchumi
  - D. Huleta hela zinazotumiwa kukarabatia baraste
42. Neno pakashume limetumiwa katika aya ya tatu, je neno hili ni la aina gani?
  - A. nomino maalum
  - B. nomino makundi
  - C. nomino ambata
  - D. kisawe
43. Methali 'Kazi mbi si mchezo mwema inamaana gani?
  - A. Kazi yoyote ile ina manufaa yake
  - B. Heri kushiriki mchezo kuliko kazi mbaya
  - C. Ni heri kujiepusha na kazi mbaya
  - D. Ni bora kucheza kuliko kufanya kazi mbaya
44. Gange na amali ni kisawe cha neno;
 

A. maliasili	B. mihadarati
C. kazi	D. hela
45. Maneno "huonekana kama kaka tupu la yai yamepigiwa mstari, yanamaanisha kuwa ardhi:
  - A. Huwa na rutuba sana
  - B. Huonekana kama haijawahi kutumiwa
  - C. Huwa na maji ya kutosha
  - D. Huonekana kama isiyo na umuhimu wowote
46. Kwa mujibu wa taarifa hii si kweli kusema kuwa:
  - A. Nchi yetu haina maliasili ya kutosha
  - B. Misitu ni mojawapo wa maliasili
  - C. Maliasili ni hidaya
  - D. Baadhi ya vijana hutumia mihadarati
47. Kulingana na ufahamu huu vijana huwacha kuwa kupe kwa jamii zao wanapopata ajira, hii ni kwa sababu:
  - A. Kupe ni vimelea wanaoshambulia vijana
  - B. Vijana sasa huwa wamekomaa
  - C. Vijana huwa wana uwezo wa kujitegemea
  - D. Uchumi haitegemei vijana hata kidogo
48. Mwandishi anasema kivutio kikubwa zaidi cha watalii ni kipi?
 

A. zaraa	B. wanyamapori
C. viwanda	D. madini
49. Ukosefu wa maji husababisha haya yote isipokuwa:
  - A. Uvundo kutokana na uchafu
  - B. Baa la njaa
  - C. Kuongezeka kwa viwanda
  - D. Ukosefu wa chemichemi
50. Kichwa mwafaka zaidi cha ufahamu huu ni:
  - A. Faida za maji
  - B. Umuhimu wa utalii
  - C. Faida za kilimo
  - D. Maliasili



1. Which part of the alimentary canal is not matched with its function?
  - A. Stomach - production of gastric juice
  - B. Colon - absorption of digested food
  - C. Oesophagus - passage of food
  - D. Small intestine - complete digestion of-food.
  
2. The blood vessel that carries scarlet blood away from the heart is \_\_\_\_\_
  - A. Vena cava
  - B. Pulmonary vein
  - C. Aorta
  - D. Pulmonary artery
  
3. Which one of the following is the final stage of HIV and AIDS infection?
  - A. Window
  - B. Full blown
  - C. Incubation
  - D. Symptomatic
  
4. The following are common communicable diseases except \_\_\_\_\_
  - A. Tetanus
  - B. Measles
  - C. Tuberculosis
  - D. Malaria
  
5. A child suffering from anaemia should be given foods rich in \_\_\_\_\_
  - A. Proteins
  - B. Vitamins
  - C. Fats
  - D. Iron
  
6. Wearing of gumboots while walking in rice fields will prevent one from contracting \_\_\_\_\_
  - A. Cholera
  - B. Typhoid
  - C. Bilharzias
  - D. Tuberculosis
  
7. Planets appear bright because they \_\_\_\_\_
  - A. Are large
  - B. Twinkle
  - C. Produce light
  - D. Reflect light

8. Name the phase of the moon shown in the diagram below.



- A. New moon
  - B. Gibbous moon
  - C. Full moon
  - D. Crescent moon
  
9. Which vaccine is administered on the thigh of a baby?
  - A. Polio vaccine
  - B. DPT vaccine
  - C. BCG vaccine
  - D. Yellow fever vaccine
  
10. Which one is a supplement feed given to animals?
  - A. Wheat bran
  - B. Hay
  - C. Silage
  - D. Pasture
  
11. Which one has a pair of traditional methods of preserving food?
  - A. Smoking and salting
  - B. Canning and freezing
  - C. Drying and freezing
  - D. Canning and salting
  
12. Which one is an emotional change in adolescents?
  - A. Enlargement of the hips
  - B. Growth of pubic hair
  - C. Being moody
  - D. Production of sex cells.
  
13. Which one of the following plant is green and non flowering?
  - A. Cactus
  - B. Moss
  - C. Puffballs
  - D. Sisal

14. Which crop pest below is not matched with its effect?

- A. Aphid- sucking sap from crop leaves
- B. Cut worm- eating the leaves of crops
- C. Stalk borer- boring into the stems of crops
- D. Weaver bird- eating grains of cereals

15. Which one of the following is a correct food chain?

- A. Grass → grasshopper → frogs → snakes
- B. Grass → grasshopper → hawks → snakes
- C. Grass → snakes → mice → hawks
- D. Grass → grasshopper → frogs → mice

16. The diagram below shows an activity carried out by standard five pupils.

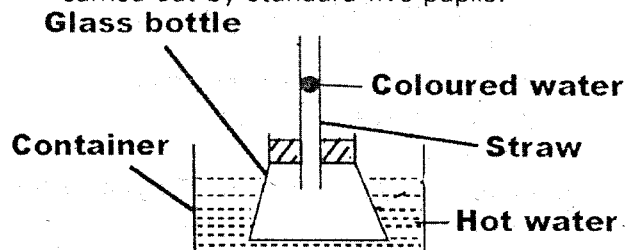

From the observation the coloured water rose as a result of \_\_\_\_\_

- A. Expansion of water
  - B. Air occupying space
  - C. Expansion of air
  - D. Liquids occupying space
17. When investigating pressure in liquids, which one of the following is not required?
- A. Collecting jar
  - B. Nail
  - C. Water
  - D. Tin
18. Sinking and floating does not depend on \_\_\_\_\_
- A. Shape
  - B. Weight
  - C. Size
  - D. Material
19. Which pair of forms of energy can travel through a vacuum?
- A. Sound and electricity
  - B. Heat and light
  - C. Sound and heat
  - D. Light and electricity

20. This bird is likely to feed on \_\_\_\_\_

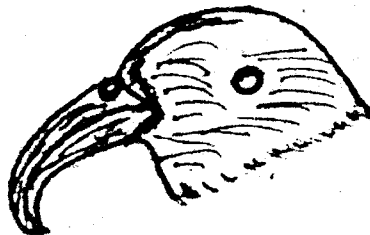

- A. Grains
  - B. Nectar
  - C. Nuts
  - D. Flesh
21. The component that makes up 0.97% of air is used in \_\_\_\_\_
- A. Germination
  - B. Electric bulbs
  - C. Photosynthesis
  - D. Making plant proteins
22. Which substance below will not change state when cooled?
- A. Ice
  - B. Water vapour
  - C. Water
  - D. Alcohol
23. Which of the following type of soil is obtained from the river bank?
- A. Loam
  - B. Sand
  - C. Clay
  - D. Sand and clay
24. The following are rotational methods of grazing except \_\_\_\_\_
- A. Herding
  - B. Paddockging
  - C. Tethering
  - D. Strip grazing
25. It is true to say both a chicken and a toad \_\_\_\_\_
- A. Use gills for breathing
  - B. Have external fertilization
  - C. Have scales on the body
  - D. Have a back bone
26. Which one of the following explains the importance of fibre in our diet?
- A. Help in transportation of digested food
  - B. Prevent constipation
  - C. Help in digestion of food
  - D. Provide the body with mineral salts

27. Which list below has foods that belong to the same food group?

- A. Ripe banana and carrot
- B. Meat and pineapple
- C. Milk and cooking oil
- D. Green banana and oranges

28. Which one does not describe an industrial use of water?

- A. Cooling engines
- B. Mixing raw materials
- C. Mixing acaricides
- D. Cleaning machines

29. During a thunderstorm you should \_\_\_\_\_

- A. Shelter under a tree
- B. Use an umbrella in an open field
- C. Wear shoes with rubber soles
- D. Lean on the wall of house

30. Which practice below does not reduce a force that opposes motion?

- A. Using rollers
- B. Making surfaces rough
- C. Streamlining bodies
- D. Applying lubricants

31. In which of the following materials will magnetism not pass through?

- A. Aluminum plate
- B. Copper coin
- C. Plastic cup
- D. Steel spoon

32. The diagram below shows the female reproductive system.

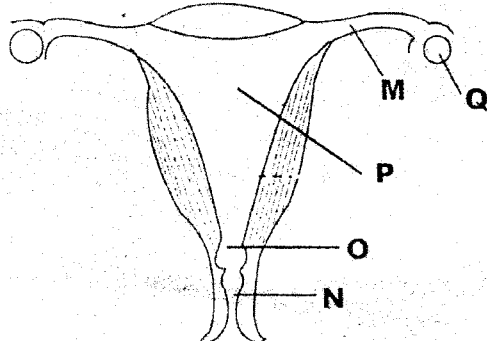

Which two parts are involved during ovulation?

- A. P and O
- B. Q and N
- C. Q and M
- D. M and O

33. Which of the following component is found in all the components of the environment?

- A. Plants
- B. Air
- C. Water
- D. Soil

34. A natural way of lighting the house is by using \_\_\_\_\_

- A. Tin lamp
- B. Electric lamp
- C. Skylights
- D. Torch

35. Spraying of farm animals will control \_\_\_\_\_

- A. Round worms and mite
- B. Fleas and ticks
- C. Tape worm and hookworms
- D. Round worms and ticks

36. Which one has crops that belong to the same group?

- A. Maize and sorghum
- B. Beans and wheat
- C. Carrots and soya
- D. Arrow roots and wheat

37. Which methods of separating mixtures are mainly used to separate solid mixtures only?

- A. Decanting and filtering
- B. Picking and decanting
- C. Sieving and filtering
- D. Winnowing and sieving

38. Shallow channels on the farm eventually lead to formation of \_\_\_\_\_

- A. Rill erosion
- B. Sheet erosion
- C. Gully erosion
- D. Splash erosion

39. Which one of the following belongs to the same group as a vulture in a feeding relationship?

- A. Hyena
- B. Chameleon
- C. Lion
- D. Weaver bird

40. Which one of the following is the largest planet?
- Mercury
  - Jupiter
  - Saturn
  - Earth
41. Standard 5 pupils saw a wind vane pointing east. In which direction was a wind sock likely to point?
- East
  - North
  - South
  - West
42. Coloured water is used in the making of a liquid thermometer because \_\_\_\_\_
- It expands faster
  - It improves visibility
  - It increases density
  - It absorbs more heat
43. In which of the following lever is the effort distance greater than the load distance?
- Wheelbarrow
  - Spade
  - Claw hammer
  - Fishing rod
44. Which one of the following is a flightless bird?
- Sunbird
  - Parrot
  - Flamingo
  - Ostrich
45. Which instrument works on the fact that light travels in a straight line?
- Microscope
  - Periscope
  - Telescope
  - Binoculars
46. Which one of the following cannot pollute water?
- Oil spillage
  - Floods
  - Treated sewage
  - Industrial effluent
47. The following are useful fungal plants except \_\_\_\_\_
- Mushroom
  - Dandruff
  - Yeast
  - Penicillin
48. Which one of the following is not a harmful substance produced when tobacco burns?
- Carbon dioxide
  - Tar
  - Nicotine
  - Carbon monoxide
49. The following are air passages. Which one is not?
- Bronchioles
  - Trachea
  - Air sacs
  - Nose
50. Which list has only narcotic drugs?
- Alcohol, miraa, tobacco
  - Bhang, alcohol, mandrax
  - Heroine, bhang, miraa
  - Bhang, heroine, cocaine

- Which one of the following numbers is two million, five thousand and fifteen?
  - 2000515
  - 2005150
  - 2005015
  - 20005015
- What number multiplies 1.09 to give 1090?
  - 100
  - 1000
  - 10000
  - 10
- Which of the following sets of measurements will give a right angled triangle?
  - 5cm, 1.2cm, 1.3cm
  - 0.3cm, 4.0cm, 5.0cm
  - 8.0cm, 1.5cm, 1.7cm
  - 0.7cm, 2.4cm, 2.5cm
- What is the value of  $\frac{2.88 - 0.32}{1.6}$ ?
  - 1.6
  - 1.48
  - 2.68
  - 0.16
- What is the place value of digit 8 in the number 198046?
  - Eight hundreds
  - Hundreds
  - Eight thousand
  - Thousands
- What is the next number in the pattern 3, 6, 11, 18, 27, ?
  - 37
  - 38
  - 39
  - 40
- Which one of the numbers below is the square of  $2\frac{1}{3}$ ?
  - $4\frac{1}{9}$
  - $18\frac{1}{3}$
  - $5\frac{4}{9}$
  - $8\frac{1}{6}$
- What is the number 689.8896 rounded off to 3 decimal places?
  - 689.890
  - 689.889
  - 689.89
  - 689.880

- What is the value of  $\frac{2}{5} \div \frac{1}{3}$  of  $\frac{3}{4}$ ?
  - $\frac{9}{50}$
  - $\frac{1}{2}$
  - $\frac{8}{25}$
  - $\frac{8}{9}$
- The perimeter of a rectangular plot is 140m. If the width of the plot is 30 metres, what is the length of the plot?
  - 35m
  - 40m
  - 55m
  - 80m
- The figure below represents a rectangular block of wood.

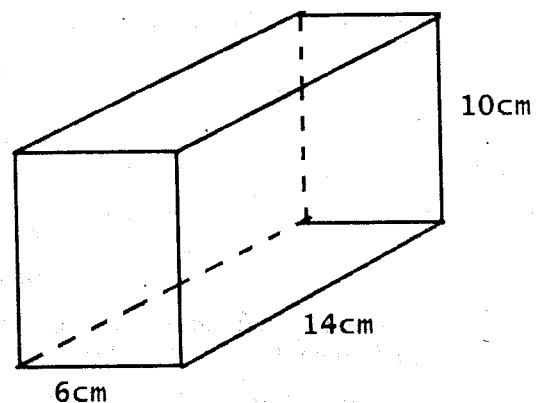

- What is the surface area of the block in  $\text{cm}^2$ ? (Take  $\pi = \frac{22}{7}$ )
- $484\text{cm}^2$
  - $400\text{cm}^2$
  - $568\text{cm}^2$
  - $840\text{cm}^2$
- The fractions  $\frac{2}{3}, \frac{3}{5}, \frac{5}{8}, \frac{5}{7}$  are to be arranged from the smallest to the largest. Which one of the following is the correct order?
    - $\frac{3}{5}, \frac{5}{8}, \frac{2}{3}, \frac{5}{7}$
    - $\frac{2}{3}, \frac{3}{5}, \frac{5}{8}, \frac{5}{7}$
    - $\frac{5}{7}, \frac{2}{3}, \frac{5}{8}, \frac{3}{5}$
    - $\frac{3}{5}, \frac{5}{8}, \frac{2}{3}, \frac{5}{7}$
  - What is the value of  $\frac{4(36 - 12) + 2 \times 2}{4}$ ?
    - 25
    - 49
    - 34
    - 67
  - What is the simplified form of the expression  $2(4x - y + 2) + 3(2x + 3y - 1)$ ?
    - $14x - 7y + 1$
    - $14x - 11y + 1$
    - $14x + 7y - 7$
    - $14x + 7y + 1$



25. In the figure below, line MN and PQ are parallel. Angle pfy =  $50^\circ$  and angle ZGF =  $120^\circ$ .

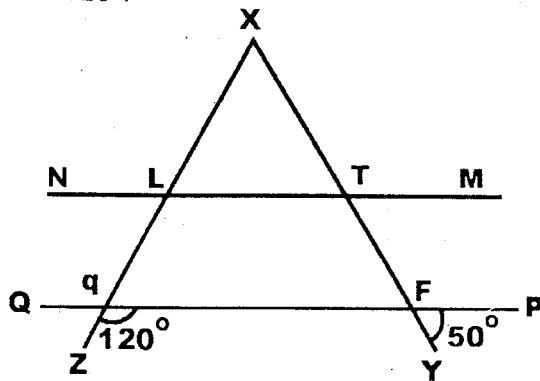

- What is the size of angle ZXY?  
 A.  $60^\circ$                       B.  $65^\circ$   
 C.  $50^\circ$                         D.  $70^\circ$
26. In a school, one bell rings after every 30 minutes while the other rings after every 40 minutes. If the two bells rang together at 8am, at what time did they ring together next?  
 A. 9.20am  
 B. 9.10am  
 C. 10.20am  
 D. 10.00am
27. A rectangular plot measuring 50m by 100m is to be fenced all round. If four strands of wire are to be used, what would be the total length of wire require in metres  
 A. 600m  
 B. 300m  
 C. 1200m  
 D. 1500m
28. What is the value of  $29 \div 8$  correct to two decimal places?  
 A. 3.63  
 B. 3.62  
 C. 3.625  
 D. 3.6
29. The perimeter of the rectangle below is 116cm

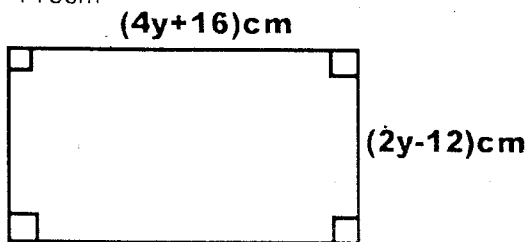

- What is the actual length of the rectangle?  
 A. 9cm                              B. 52cm  
 C. 6cm                                D. 104cm

30. How many times is the value of the digit 8 more than the value of digit 2 in the number 8123?  
 A. 7980  
 B. 6  
 C. 400  
 D. 100

31. The figure below shows lines AB, CD and EF which intersect at point O.

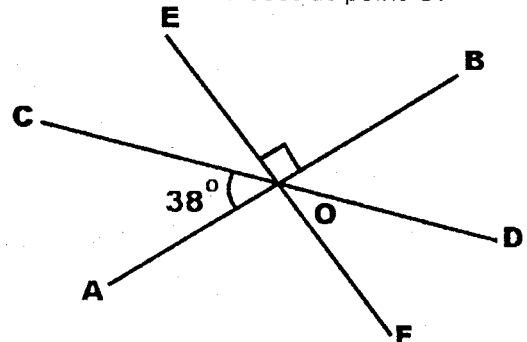

- What is the size of angle DOF?  
 A.  $52^\circ$                               B.  $38^\circ$   
 C.  $90^\circ$                                 D.  $42^\circ$

32. How many cubes were used to make the stack below?

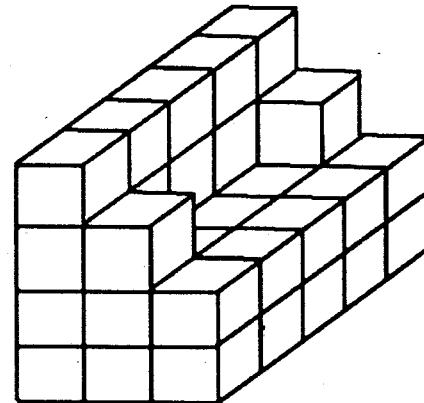

- A. 45                                      B. 60  
 C. 40                                      D. 42

33. What is the sum of the first 45 odd numbers?  
 A. 1225  
 B. 2025  
 C. 1925  
 D. 2125

34. The bus fare from one town to another was decreased by 20%. If the fare became sh500, what was the decrease?

- A. Sh 625
- B. Sh 100
- C. Sh 125
- D. Sh 600

35. What is 8.125 as a fraction in simplest form?

- A.  $81\frac{1}{4}$
- B.  $8\frac{1}{4}$
- C.  $8\frac{3}{8}$
- D.  $8\frac{1}{8}$

36. Divide 46069 by 23. What do you get?

- A. 2003
- B. 203
- C. 23
- D. 2300

37. Kosgei bought land for sh 4505600.

This was sh 945650 more than what Bundi paid for his land. How much did Bundi pay?

- A. Sh3659950
- B. Sh 3569950
- C. Sh 3559950
- D. Sh 5451250

38. Study the figure below in which line AB is parallel to line CD and line XY is the line of transversal.

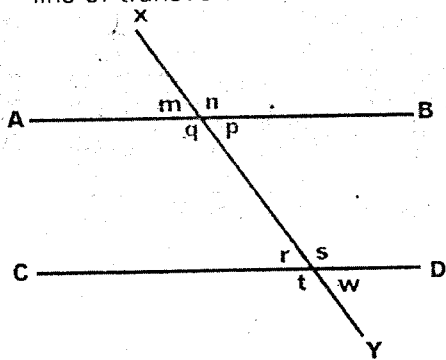

Which statement below is NOT true?

- A.  $t = n$
- B.  $p + s = m + q$
- C.  $m + p = w + r$
- D. m and r are vertically opposite angles.

39. Construct triangle EFG such that  $FG = 6\text{cm}$ ,  $EF = 7.5\text{cm}$  and  $EG = 6.3\text{cm}$ .

What is the measure of angle EGF?

- A.  $75^\circ$
- B.  $85^\circ$
- C.  $105^\circ$
- D.  $55^\circ$

40. A certain quadrilateral has the following properties:

- All the sides are equal
- Opposite sides are parallel
- Diagonals bisect each other at right angles
- Diagonals bisect the angles at the vertices
- Some angles are equal

Which quadrilateral has the above properties?

- A. Square
- B. Rhombus
- C. Rectangle
- D. Parallelogram

41. Mellisa slept at 2145h on Thursday and woke up six hours later. On what day and time did she wake up?

- A. Thursday 3.45am
- B. Friday 3.45am
- C. Friday 3.45pm
- D. Thursday 3.45pm

42. Godana paid sh 24000 for a phone after getting a 20% discount. What was the marked price of the phone?

- A. Sh 20,000
- B. Sh 19200
- C. Sh 28800
- D. Sh 30000

43. What is the area of the quadrilateral drawn below?

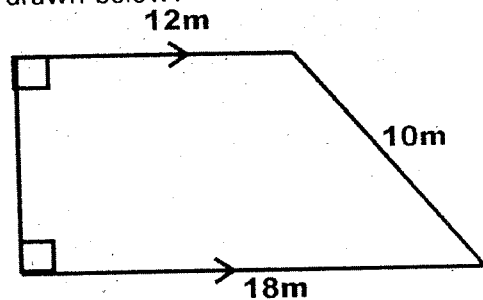

- A.  $120\text{m}^2$
- B.  $90\text{m}^2$
- C.  $150\text{m}^2$
- D.  $240\text{m}^2$

44. Kyungu spent his money as follows:  $\frac{2}{7}$  on rent,  $\frac{2}{3}$  of the remainder on food and saved the rest. What fraction of the money did he save?

- A.  $\frac{10}{21}$
- B.  $\frac{1}{21}$
- C.  $\frac{5}{21}$
- D.  $\frac{16}{21}$



45. An open cylinder has a radius of 7cm and a height of 20cm. What is its surface area? (Take  $\pi \approx 22/7$ )
- A. 1188cm<sup>2</sup>  
 B. 3080cm<sup>2</sup>  
 C. 1034cm<sup>2</sup>  
 D. 594cm<sup>2</sup>

46. The table below shows postal rates for sending a money order.

Value of order in sh	Commission
Not exceeding 500	Sh 42
501-1000	Sh 114
1001-3000	Sh 174
3001-5000	Sh 209
5001-10000	Sh 295
10001-20000	Sh 441
20001-30000	Sh 617

Mudavadi sent two money orders, one for sh 16000 and the other sh 10000. How much money did he pay at the post office altogether?

- A. Sh 736  
 B. Sh 26000  
 C. Sh 26617  
 D. Sh 26736
47. Three standard 7 pupils contributed sh 575 to buy a story book. Halima contribute three times as much as Nanjala while Kwekwe contributed sh 15 more than Halima. If the amount contributed by Nanjala is represented by the sh x, which one of the following

equations can be used to get the value of x?

- A.  $3x + 21 = 575$   
 B.  $7x + 15 = 575$   
 C.  $7x - 15 = 575$   
 D.  $4x + 15 = 575$

48. A sugar factory packed 3 tonnes of sugar in 500g packets. How many packets were packed?

- A. 6000  
 B. 600  
 C. 60  
 D. 6

49. What is the value of x in the equation  $\frac{1}{3}(2x - 1) = 15$ ?

- A. 23  
 B. 22  
 C. 46  
 D. 44

50. The figures below show a pattern of shapes.

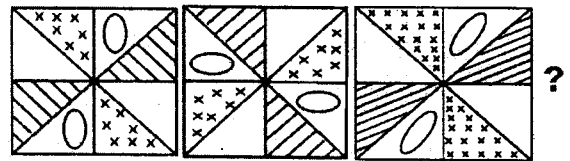

Which one of the following shapes below should be drawn in the blank box to continue with the pattern?

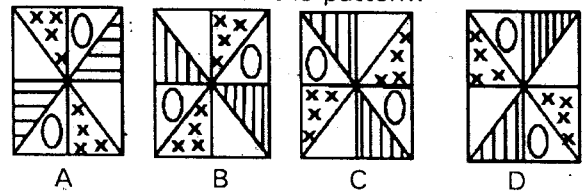

# FOTO AREA

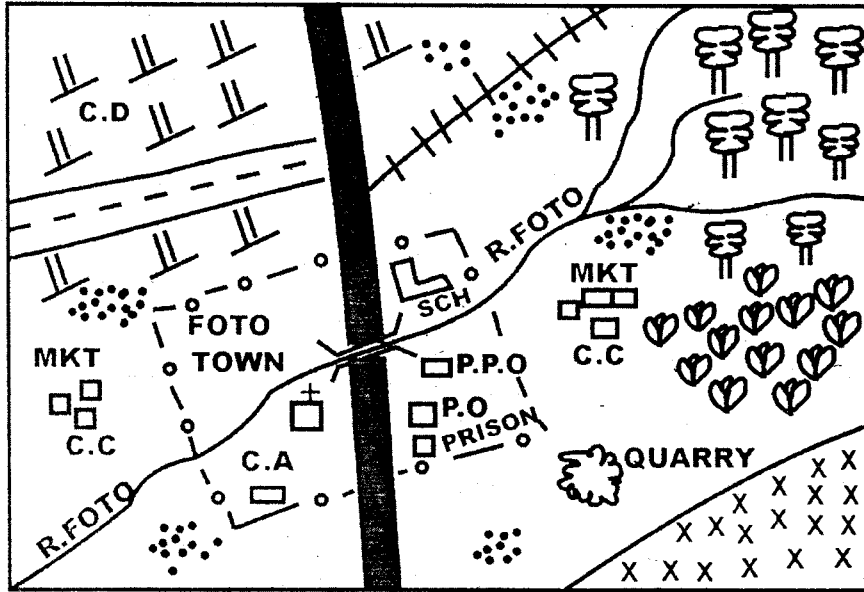

## SCALE

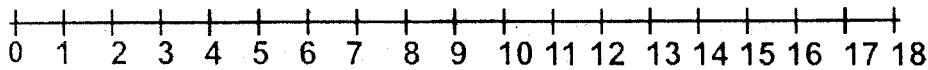

## KEY

- TARMAC ROAD
- MURRAM ROAD
- FOREST
- RAILWAY
- SHRUBS
- PERMANENT BUILDINGS
- C.A** — COUNTY ASSEMBLY
- MKT** — MARKET

- SCH** — SCHOOL
- P.P.** — POLICE POST
- P.O** — POST OFFICE
- C.C** — CHIEF'S CAMP
- TEA
- GAME RESERVE
- C.D** — CATTLE DIP
- SETTLEMENTS
- CHURCH

Use the map of Foto area to answer questions 1-7

1. What is the approximate length of the tarmac road in the area represented by the map?
  - A. 12 km
  - B. 18 km
  - C. 6 km
  - D. 22 km
2. What climatic conditions are experienced in the North-Western part of Foto area?
  - A. Hot and wet conditions
  - B. Hot and dry conditions
  - C. Cool and dry conditions
  - D. Cool and wet conditions
3. The settlement pattern in the area covered by the map can generally be described as \_\_\_\_\_
  - A. Scattered
  - B. Dispersed
  - C. Linear
  - D. Clustered
4. Foto town serves the following functions except one. Which one is it?
  - A. It is a religious centre
  - B. It is an educational centre
  - C. It is a health centre
  - D. It is a communication centre

5. Foto area slopes towards one of the following directions. Which one is it?  
 A. North - East  
 B. South - East  
 C. South - West  
 D. North - West
6. Who among the following is elected to represent Foto area in the National Assembly?  
 A. The county representative  
 B. The woman representative  
 C. The senator  
 D. The Governor
7. All the following statements are true about the area represented by the map except one. Which one is it?  
 A. The soils found in the Eastern part of the map are likely to be sandy soils.  
 B. Tourism is being practised in the South- Eastern part of the map.  
 C. The North-Western part of the map experiences arid conditions  
 D. There are security services in the area represented by the map.
8. Which of the following is NOT part of the social organization of the San community in the pre-colonial period?  
 A. They believed in the existence of God  
 B. They recognized the praying mantis as God's symbol on earth  
 C. They practised polygamy and lived communally  
 D. They were ruled by hereditary chiefs
9. The kingdom of old Ghana collapsed when it was attacked by Berbers from the North known as  
 A. Almoravids  
 B. Tuaregs  
 C. Khartoumers  
 D. Creoles
10. Which of the European nations was NOT involved in the scramble and partition of Africa?  
 A. Spain  
 B. Portugal  
 C. France  
 D. Sweden
11. Three of the following statements are true of Masaku who was a traditional leader of the Akamba. Which one is NOT?  
 A. He prophesied the construction of the railway in the area.  
 B. He treated people using herbs  
 C. He collaborated with the British  
 D. He lived on one of the hills near the present day Machakos town.
12. Which of these Eastern African communities was traditionally ruled by a council of elders?  
 A. Abawanga  
 B. Baganda  
 C. Wanyamwezi  
 D. Ameru
13. Three of the following leaders collaborated with the colonialists during the colonial period. Who did not?  
 A. Kabaka Mutesa I  
 B. Nabongo Mumia  
 C. Mekatilili wa Menza  
 D. Laibon Lenana
14. The following describes an early visitor in Eastern Africa.  
 i. He was a journalist  
 ii. He came to Eastern Africa in search of an explorer  
 iii. He met the explorer he was looking for at Ujiji in 1871  
 iv. He explored around River Lualaba and River Congo. The explorer described above is  
 A. John Speke  
 B. Richard Burton  
 C. Joseph Thomson  
 D. Henry Morton Stanley
15. Who among the following personalities was involved in trade in Eastern Africa?  
 A. Vasco Da Gama  
 B. Johann Rebmann  
 C. Carl Peters  
 D. Jame Grant
16. The following countries are found in Africa  
 i. Ghana  
 ii. Kenya  
 iii. Tanzania  
 iv. Somalia

Which of these is the CORRECT order in which these countries achieved their independence?

- A. iv, iii, ii, and i
- B. i, ii, iii, and iv
- C. i, iv, iii, and ii
- D. ii, iii, iv and i

17. In which of the following years did Zanzibar, Pemba and Tanganyika unite to form the united Republic of Tanzania?

- A. 1960
- B. 1964
- C. 1967
- D. 1977

18. Three of the following statements are true of Haile Selassie of Ethiopia. Which one is NOT?

- A. He formed the political association that led his country to achieve independence.
- B. He abolished the ownership of slaves in Ethiopia
- C. He supported liberation movements in Africa
- D. He organized his government into ministries.

19. The headquarters of IGAD are based in one of the following Eastern African Countries. Which one is it?

- A. Eritrea
- B. Ethiopia
- C. South Sudan
- D. Djibouti

20. The following describes a philosophy in Kenya

- i. It promotes equal participation in economic activities
- ii. It promotes political democracy
- iii. It promotes equal distribution of the national wealth
- iv. It was established in 1965 through the efforts of Jomo Kenyatta and Tom Mboya.

The philosophy described above is known as

- A. African socialism
- B. Harambee
- C. Nyayoism
- D. Pan-Africanism

21. The following factors promote peace. Which one does not?

- A. The rule of law
- B. Tolerance
- C. Dialogue
- D. Cattle rustling

22. One of the following is an economic right. Which one is it?

- A. The right to life
- B. The right to vote
- C. The right to work
- D. The freedom of association

23. In Kenya, election petitions involving presidential candidates are heard and determined by one of the following courts. Which one is it?

- A. Supreme court
- B. High court
- C. Court of appeal
- D. The chief magistrate court

24. Who among the following personalities in Kenya has never served as a vice-president?

- A. George Saitoti
- B. Josphat Karanja
- C. Joseph Murumbi
- D. Masinde Muliro

25. A member of the county assembly can not lose his seat if he or she

- A. Is found to be of unsound mind
- B. Is sentenced to a prison term of more than six months
- C. Differs in opinion with the county governor
- D. Defects officially from the party that sponsored him or her to the county assembly.

26. Which of these sets of Communities is composed of highland nilotes only?

- A. Dinka, Nuer and Shilluk
- B. Karamojong, Acholi and Langi
- C. Azande, Toposa and Nandi
- D. Kipsigis, Sebei and Marakwet

27. Some of the semitic speakers of Ethiopia are the

- A. Oromo and Tigre
- B. Amhara and Falasha
- C. Ogaden and Beja
- D. Afar and Hawiyah

28. The Berbers, Tuaregs and Arabs are communities found in one of the following regions of Africa. Which one is it?
- Western Africa
  - Eastern Africa
  - Southern Africa
  - Northern Africa

29. The following relates to a community in Africa.

- They are believed to be the earliest people to occupy Africa.
- They are short with an adult being about 1.3 metres tall
- Their life is largely communal
- They traditionally lived by hunting and gathering

The community described above are the

- |            |               |
|------------|---------------|
| A. Bambuti | B. Afrikaners |
| C. Zulu    | D. Bakongo    |

30. Below are statements about the migration of a community into Kenya during the pre-colonial period.

- They migrated from the Bahr-el-Ghazal region in Southern Sudan.
- They settled at Pubungu Pakwach in Uganda before moving into Kenya in three groups
- They settled along the shores of Lake Victoria

The community whose migration pattern is described above is the

- |             |             |
|-------------|-------------|
| A. Abagusii | B. Abakuria |
| C. Luo      | D. Pokot    |

31. In traditional African societies age-groups are formed mainly through

- Marriage
- Initiation
- Naming
- Becoming a warrior

32. In the African traditional societies, children learnt through the following ways except one. Which one is it?

- Through use of proverbs
- Through apprenticeship
- Through reading stories
- Through imitation

33. Which of these arms of the government is involved in implementing all government policies?

- Legislature
- Judiciary
- Executive
- Parliament

34. Public primary schools in Kenya are directly managed by the \_\_\_\_\_

- County Government
- School committee
- School prefects
- Local community

35. Who among the following people is authorized to conduct a civil marriage in Kenya?

- A pastor
- A kadhi
- Attorney General
- A clan elder

36. Three of the following statements are true of the school motto except one. Which one is it?

- The school motto encourages members of the school to work hard
- The school motto describes the aims of a school
- The school motto is usually written in the school's badge.
- All the school mottos are written in English language.

Use the map of Africa below to answer questions 37-40

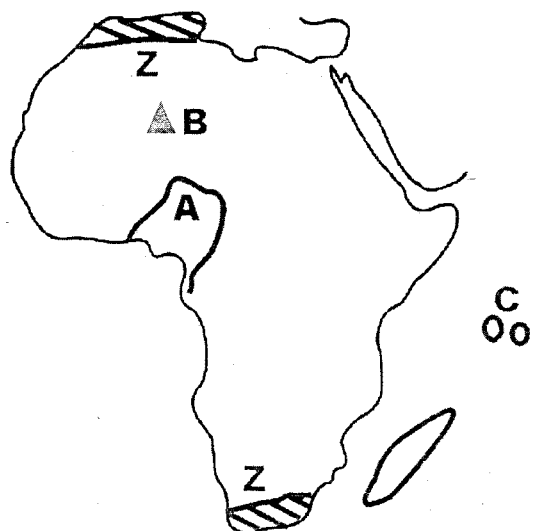

37. The physical feature marked B on the map
- Is mount Cameroon
  - Is mount Ras Dashen
  - Was formed through faulting
  - Was formed through volcanic action
38. One characteristic of the climatic region shaded and marked Z on the map is that
- It experiences high temperatures throughout the year
  - It experiences high rainfall throughout the year
  - It experiences hot and wet summers
  - It experiences cool and wet winters
39. The MAIN mineral mined in the country marked A on the map is
- Bauxite
  - Petroleum
  - Gold
  - Copper
40. The capital city of the Island country marked C on the map is
- Victoria
  - Maseru
  - Freetown
  - Port Louis
41. One complete revolution of the earth takes-
- 48 hours
  - 24 hours
  - 365  $\frac{1}{4}$  days
  - 400 days
42. Which one of the following plateaus is CORRECTLY matched with the country where it is located?
- Ahaggar plateau - Chad
  - Nyika plateau - Sudan
  - Bie plateau - Angola
  - Jos Plateau - Cameroon
43. One of the following features was formed as a result of wind action. Which one is it?
- Lake Shala
  - Lake Tana
  - Qattara depression
  - Lake Utange
44. The following describes a type of soil
- It has large air spaces
  - It has large particles
  - Supports growth of cashew nuts, coconuts and pasture
- The soil described above is
- Sandy soil
  - Black cotton soil
  - Volcanic soil
  - Loam soil
45. Three of the following statements are true of desert vegetation. Which one is NOT?
- It consists of thorny plants such as cactus
  - It has scattered thorny bushes and tough bunches of grass.
  - It has plants with thin, spiky needle shaped leaves
  - It has evergreen trees that form canopies at the top
46. Which of these plains is located in Manderia County?
- Lokitipi plain
  - Awara plain
  - Loita plain
  - Athi - Kapiti plain
47. The Congo basin is found in one of the following climatic regions. Which one is it?
- Savannah climate
  - Desert climate
  - Equatorial climate
  - Mountain climate
48. Which of these units are used in measuring the atmospheric pressure?
- Millibars
  - Knots
  - Millimeters
  - Degrees
49. The following rivers are found in Africa
- River Nile
  - River Congo
  - River Atbara
  - River Zambezi
  - River Limpopo
  - River Juba

Which of the above rivers have their mouths in the Indian Ocean?

- A. i, ii and iii  
 B. ii, iii and iv  
 C. iv, v and vi  
 D. iii, iv and v
50. African rivers are not navigable due to various reasons except one. Which one is it?  
 A. Some have a floating vegetation  
 B. Some have rapids and cataracts  
 C. Some are very wide  
 D. Some have fluctuating water levels
51. The following are pyrethrum growing areas in Kenya. Which one is NOT?  
 A. Lamu  
 B. Nyeri  
 C. Molo  
 D. Nyandarua
52. The following describes a crop grown in Kenya  
 i. It can grow in any type of soil  
 ii. It can withstand long periods of drought.  
 iii. It requires plenty of sunshine  
 iv. It can grow in altitudes ranging from the sea level to 1800 metres.

The crop described above is

- A. Coffee  
 B. Sisal  
 C. Pyrethrum  
 D. Wheat
53. The following describes a pastoral community in Africa.  
 i. They live in the Sahel region  
 ii. They practice transhumance  
 iii. They keep livestock as their source of wealth  
 iv. They use horses to search for water and pasture.

The community described above is

- A. The Fulani  
 B. The Tswana  
 C. The Maasai  
 D. The Ankole

54. The following are multipurpose river projects in Africa. Which among them is located in Ghana?  
 A. The Seven Forks scheme  
 B. The Volta river scheme  
 C. The Kariba dam project  
 D. The Aswan High dam
55. One of these minerals mined in Kenya is obtained through dredging. Which one is it?  
 A. Fluorspar  
 B. Diatomite  
 C. Soda ash  
 D. Salt
56. Which of these types of fish are caught in marine fishing grounds only  
 A. Tuna, mullet and Kingfish  
 B. Tilapia, shellfish and sailfish  
 C. Omena, Nile perch and mullet  
 D. Trout, mullet and sword fish
57. Leather tanneries and sawmills are classified under  
 A. Secondary industries  
 B. Manufacturing industries  
 C. Tertiary industries  
 D. Processing industries
58. The headquarters of SADC trading bloc are located in  
 A. Lusaka in Zambia  
 B. Gaborone in Botswana  
 C. Abuja in Djibouti  
 D. Djibouti in Djibouti
59. Which of these tourist attractions is CORRECTLY matched with the country where it is found?  
 A. Kruger National Park – Botswana  
 B. Pyramids of Giza – Ethiopia  
 C. Table mountains – South Africa  
 D. Coastal beaches – Zimbabwe
60. The following describes a major town in Eastern Africa.  
 i. It is a tourism centre  
 ii. It is a major industrial centre  
 iii. It is an agricultural collection centre.  
 iv. It is an inland port.
- The town described above is known as  
 A. Jinja  
 B. Dodoma  
 C. Kampala  
 D. Mombasa

### C.R.E

61. The following were consequences of the sin committed by Adam and Eve at the garden of Eden except one. Which one is NOT?
- A. The woman was to be subject to her husband
  - B. The woman was to give birth in pain
  - C. Death sentence was passed upon all the people in the world.
  - D. Both the man and the woman started working in the garden of Eden.
62. The earth, plants and water bodies were created by God in one of the following days of God's creation. Which one is it?
- A. The fourth day
  - B. The third day
  - C. The fifth day
  - D. The second day
63. Which of these is a historical book in the Old Testament
- A. Esther
  - B. Job
  - C. Genesis
  - D. Lamentation
64. One of these commandments of God was broken by Israelites when they built a golden calf in the wilderness under the leadership of Aaron. Which one is it?
- A. The third commandment
  - B. The sixth commandment
  - C. The second commandment
  - D. The fourth commandment
65. What a terrifying place this is! It must be the gate that opens to heaven (Genesis 28:17). Who among the following said these words?
- A. Abraham
  - B. Lot
  - C. Jacob
  - D. Joseph
66. Who among the following built an altar to represent God during the sealing of the covenant between God and Israelites at Mount Sinai?
- A. Caleb
  - B. Moses
  - C. Oholiab
  - D. Korah
67. The story of David and Jonathan teaches Christians to \_\_\_\_\_
- A. Be humble at all times
  - B. Be sincere and trustworthy at all times
  - C. Be courageous in times of trouble
  - D. Be generous to those who are poor.
68. Bezalel son of Uri had the ability for various skills. Which of these is NOT one of them?
- A. Weaving
  - B. Working with gold
  - C. Embroidery
  - D. Composing poems
69. Which of these was an excuse given by Jeremiah when God called him to be a prophet in Judah?
- A. He said that he was not an eloquent speaker
  - B. He said that he was too old
  - C. He said that he was sinful
  - D. He said that he was from a poor family
70. Who among the following was compared by Prophet Nathan to a rich man who had taken the only poor man's lamb?
- A. King Ahab
  - B. King Saul
  - C. King David
  - D. King Jeroboam
71. The following were the sons of Noah except one. Who is it?
- A. Shem
  - B. Japheth
  - C. Ham
  - D. Seth
72. Three of the following miracles were performed by prophet Elijah. Which one was NOT?
- A. He created a dry ground along the river.
  - B. He raised the son of the widow at Zarephath
  - C. He multiplied the flour and oil for the widow at Zarephath
  - D. He recovered the lost axe-head
73. On which occasion in the life of Jesus did Moses and Elijah appear?
- A. His baptism
  - B. His crucifixion
  - C. His resurrection
  - D. His transfiguration



74. Who among the following women was present when Jesus was dedicated in the temple?
- Salome
  - Joanna
  - Anna
  - Elizabeth
75. Happy are those who work for peace, God will call them His children" (Matthew 5:9). These words were spoken by Jesus
- During His triumphant entry into Jerusalem
  - During His preaching on a mountain
  - During His arrest at the garden of Gethsemane
  - During His transfiguration on a high mountain
76. Which of these parables of Jesus teaches how different people receive God's word?
- Parable of the good Samaritan.
  - Parable of the prodigal son
  - Parable of the Pharisee and the tax collector
  - Parable of the sower
77. One of these sets consist of secular values. Which one is it?
- Humility, mercy and purity
  - Purity, peace and charity
  - Wealth, pride and fame
  - Poverty, charity and faithfulness
78. The state of feeling positive about ourselves is known as
- Self - esteem
  - Integrity
  - Good grooming
  - Responsibility.
79. The education the missionaries gave the Africans in Kenya was aimed at developing the people in the following ways except one. Which one is it?
- Spiritual growth
  - Physical growth
  - Moral uprightness
  - Promiscuous behaviour
80. The lame man who was healed by Peter and John use to beg at
- A synagogue in Nazareth
  - The beautiful Gate in Jerusalem.
  - A synagogue in Jericho
  - The temple in Shiloh
81. Members of the early church did three of the following things together except one. Which one is it?
- Fellowshipping together
  - Sharing belongings with one another
  - Praying together
  - Pouring libation together
82. Who among the following was one of the seven helpers in the early church?
- Paul
  - Barnabas
  - Cleopas
  - Stephen
83. Jesus healed two mad men in a region known as
- Gadara
  - Sychar
  - Troas
  - Antioch
84. HIV/AIDS can be spread from one person to another through the following ways except one. Which one is it?
- Through sex with an infected person
  - Through sharing tooth brushes and razors
  - Through hugging an infected person
85. Three of the following statements are true of Nicodemus. Which one is NOT?
- He acknowledged that Jesus was a great teacher
  - He was a secret disciple of Jesus
  - He was a Roman soldier
  - He was a Jewish leader and a Pharisee
86. According to the Apostles' creed Jesus is
- Our Lord
  - The Creator
  - The Father
  - Very powerful

87. One of the following shows a fruit of the Holy, Spirit. Which one is it?

- A. Preaching the word of God
- B. Healing the sick of their illness
- C. Being kind to the poor
- D. Interpreting different tongues

88. In the African traditional societies, the wealth of an individual was measured in the following ways except one. Which one is it?

- A. The size of children
- B. The number of children
- C. The size of the granary
- D. The number of certificates one has

89. Who among the following were in charge of teaching children their responsibilities in the traditional African society?

- A. Friends
- B. Parents
- C. Age mates
- D. Priests

90. Your desk mate makes a lot of noise during study time. This is affecting your performance. As a Christian what is the best action to take?

- A. Inform your parents about it.
- B. Inform the class teacher about it
- C. Advise the desk mate to stop the habit
- D. Incite other classmates against the desk mate.









HIGH FLYER  
SERIES  
007

# HIGH FLYER TRIAL EXAM 2016

## STANDARD SEVEN

### MARKING SCHEME

ENGLISH	KISWAHILI	MATHS	SCIENCE	SOCIAL STUDIES	
1. B	1. D	1. C	1. B	1. A	<u>I.R.E</u>
2. B	2. C	2. B	2. C	2. B	1. B
3. D	3. B	3. D	3. B	3. D	51. A
4. A	4. A	4. A	4. A	4. C	52. B
5. C	5. C	5. D	5. D	5. C	53. A
6. C	6. C	6. B	6. C	6. B	54. B
7. B	7. B	7. C	7. D	7. A	55. C
8. B	8. D	8. A	8. D	8. A	56. A
9. C	9. C	9. C	9. B	8. D	57. D
10. D	10. A	10. B	10. A	9. A	58. B
11. C	11. B	11. C	11. A	10. D	59. C
12. A	12. C	12. A	12. C	11. C	60. A
13. A	13. D	13. A	13. B	12. D	
14. A	14. D	14. D	14. B	13. C	
15. C	15. B	15. B	15. A	14. D	
16. B	16. A	16. C	16. C	15. C	
17. B	17. A	17. C	17. A	16. C	<u>C.R.E</u>
18. B	18. C	18. B	18. C	17. B	61. D
19. C	19. B	19. D	19. B	18. A	62. B
20. C	20. D	20. A	20. D	19. D	63. A
21. D	21. C	21. B	21. B	20. A	64. C
22. D	22. A	22. A	21. B	21. D	65. C
23. D	23. B	23. C	22. A	22. C	66. B
24. B	24. D	24. B	23. C	23. A	67. B
25. A	25. B	25. D	24. A	24. D	68. B
26. B	26. A	26. D	25. D	25. C	69. A
27. B	27. D	27. C	26. D	26. D	70. C
28. A	28. C	28. A	27. A	27. B	71. D
29. C	29. D	29. B	28. C	28. D	72. D
30. A	30. B	30. C	29. C	29. A	73. D
31. D	31. B	31. A	30. B	30. C	74. C
32. D	32. D	32. D	31. D	31. B	75. B
33. A	33. A	33. B	32. D	32. C	76. D
34. B	34. C	34. C	33. B	33. C	77. C
35. A	35. D	35. D	34. C	34. B	78. A
36. B	36. D	36. A	35. B	35. C	79. D
37. D	37. C	37. C	36. A	36. D	80. B
38. C	38. A	38. D	37. D	37. D	81. D
39. D	39. A	39. A	38. C	38. D	82. D
40. C	40. C	40. B	39. A	39. B	83. A
41. D	41. B	41. B	40. B	40. A	84. C
42. C	42. C	42. D	41. D	41. C	85. C
43. A	43. C	43. A	42. B	42. C	86. A
44. C	44. C	44. C	43. A	43. C	87. C
45. B	45. D	45. C	44. D	44. A	88. D
46. D	46. A	46. D	45. B	45. D	89. B
47. A	47. C	47. B	46. C	46. B	90. C
48. B	48. B	48. A	47. B	47. C	
49. D	49. C	49. A	48. A	48. A	
50. A	50. D	50. C	49. C	49. C	
			50. D	50. C	
					2. C
					3. B
					4. B
					5. C
					6. C
					7. B
					8. C
					9. D
					10. C
					11. B
					12. C
					13. D
					14. B
					15. A
					16. B
					17. C
					18. D
					19. C
					20. B
					21. C
					22. C
					23. D
					24. B
					25. C
					26. A
					27. B
					28. B
					29. D
					30. A