



HIGH FLYER SERIES TRIAL EXAMINATION
NURSERY – 2016
READING

NAME: _____

CLASS: _____

Read the following sounds and pictures.

a b c d e f g h i j

k l m n o p q r s t

u v w x y z

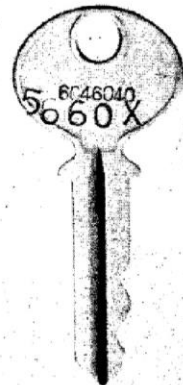
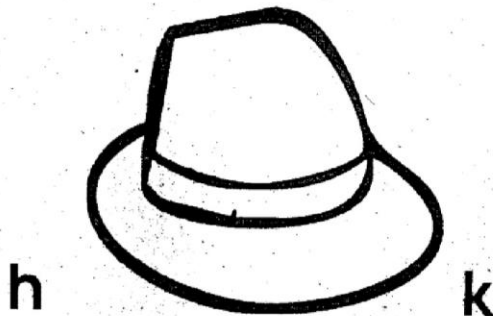
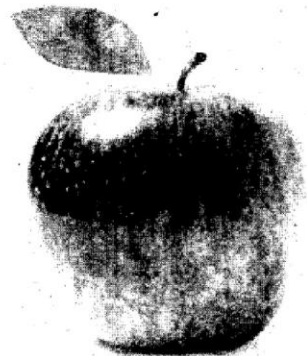
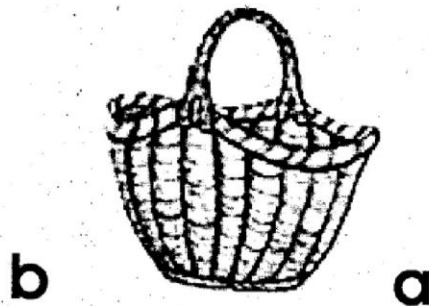
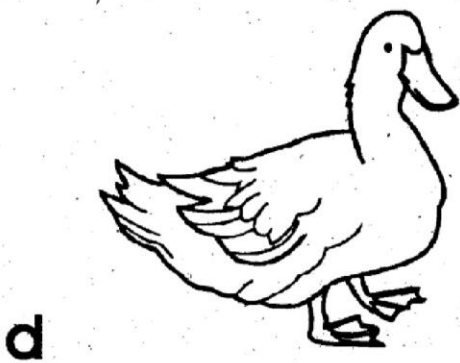



HIGH FLYER SERIES TRIAL EXAMINATION

NURSERY – 2016

LANGUAGE

NAME: _____

CLASS: _____

Write the missing sounds

1. a ____ c ____ e ____

g ____ l ____ k ____

2. m ____ o ____ q ____ s ____

u ____ w ____ y ____

3. a b c ____ ____

____ ____ ____

Copy the sounds

4. a ____ ____ ____

5. b ____ ____ ____

6. c ____ ____ ____

7. d ____ ____ ____

Circle the odd one out

8. m m p m m

9. d e d d d

10. b b g b b

11. f f k f f

12. c c c n c

Match Sounds to Pictures and colour

13. a



14. b

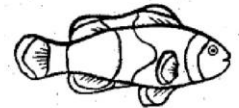

15. c



16. d



17. e



18. f



19. g



20. h





HIGH FLYER SERIES TRIAL EXAMINATION NURSERY – 2016 CREATIVE AND PATTERNS

NAME: _____

CLASS: _____

Colour these pictures

1.

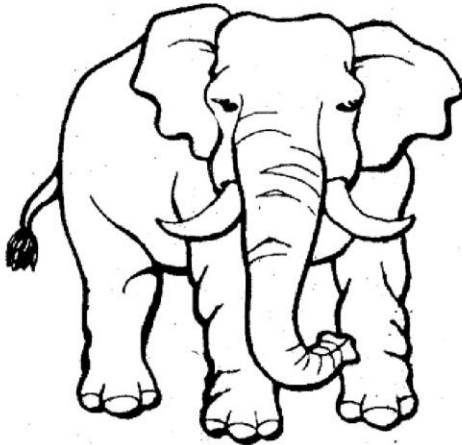

2.

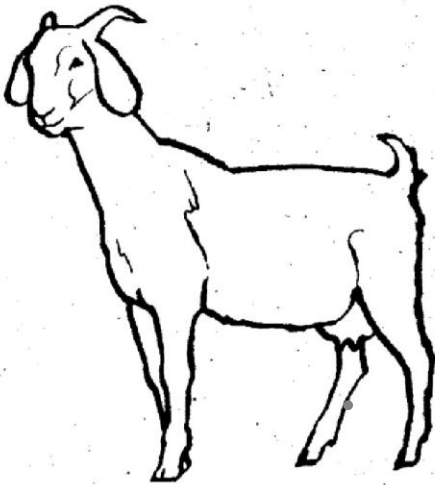

3.

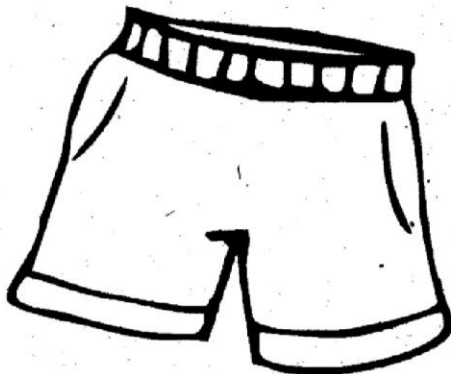

4.



5.

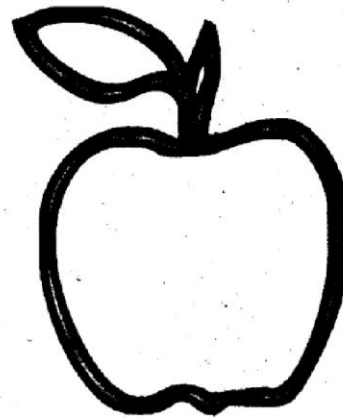

Copy the patterns

6. =+=+=+ _____

7. ○=○=○=○ _____

8. ==+===+ _____

9. |c=|c= _____

10. b=b=b=b _____



HIGH FLYER SERIES TRIAL EXAMINATION

NURSERY – 2016

NUMBER WORK





NAME: _____ CLASS: _____

Count and circle the correct numbers

1.  = 1 2 3

2.  = 3 2 1

3.  = 1 2 3

4.  = 1 2 3 4

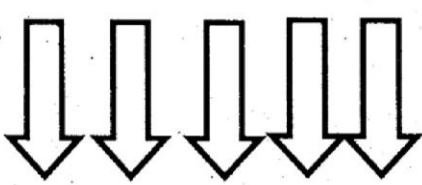
5.  = 1 2 3 4 5

Count and Match the numbers

6. G G G G G G 10

7. Y Y Y Y Y Y Y 9

8. M M M M M M M M 8

9. D D D D D D D D D 6

10. X X X X X X X X X X 7

Circle the odd one out

11. 2 2 5 2 2

12. 4 4 6 4 4

13. 2 2 5 2 2

14. 3 7 3 3 3

15. 5 1 5 5 5

16. 2 2 5 2 2

17. 4 3 4 4 4

Copy the numbers

18. 1 _____

19. 2 _____

20. 3 _____

21. 4 _____

Count and write

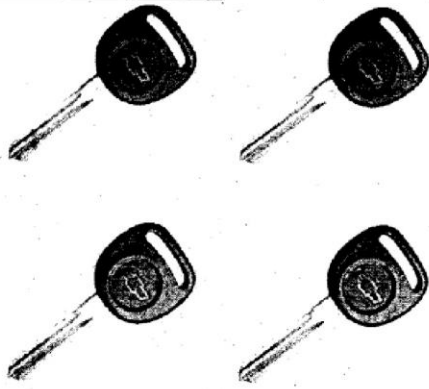
22. 
= _____

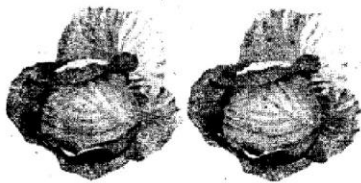
23.  =

24. 
= _____

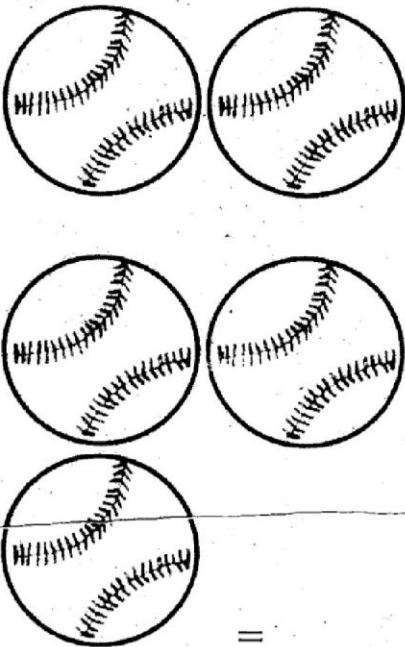
25. 
= _____



HIGH FLYER SERIES TRIAL EXAMINATION NURSERY – 2016 ENVIRONMENTAL STUDIES

NAME: _____

CLASS: _____

Colour the pictures

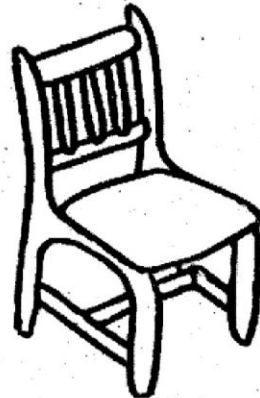
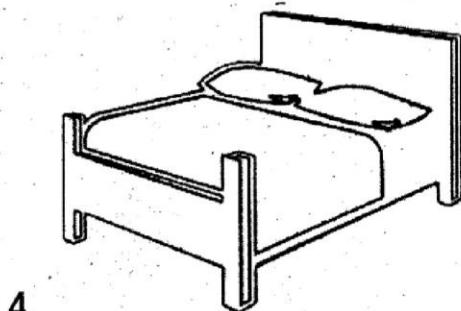
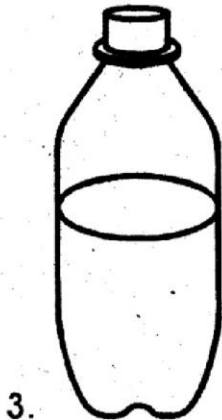
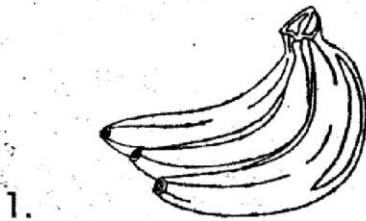

Answer the following questions (orally)

6. What is your name?

7. Are you a boy or a girl?

8. How old are you? _____

9. This is a



10. It has _____ wheels.