

**MATHEMATICS**

**Time: 2 HOURS**

**READ THESE INSTRUCTIONS CAREFULLY**

1. You have been given this question booklet and a separate answer sheet. The question booklet contains 50 questions.
2. Do any necessary rough work in this booklet.
3. When you have chosen your answer, mark it on the **ANSWER SHEET**, not in the question paper.

**HOW TO USE THE ANSWER SHEET**

4. Use an ordinary pencil only.
5. Make sure that you have written on the answer sheet.

**YOUR INDEX NUMBER**

**YOUR NAME**

**NAME OF YOUR SCHOOL**

6. By drawing a **dark line** inside the correct numbered boxes mark your full Index Number (i.e. School Code Number and the three-figure Candidate's Number) in the grid near the top of the answer sheet.
7. Do not make any marks outside the boxes.
8. Keep your answer sheet as clean as possible and **DO NOT FOLD IT**.
9. For each of the Questions 1 - 50 four answers are given. The answers are lettered A, B, C, D in each case only **ONE** of the four answers is correct. Choose the correct answer.
10. On the answer sheet show the correct answer by drawing a **dark line** inside the box in which the letter you have chosen is written.

**Example**

**In the question Booklet:**

39. What is the square root of  $2\frac{7}{81}$  ?

- A.  $\frac{9}{13}$
- B.  $1\frac{2}{3}$
- C.  $1\frac{4}{9}$
- D.  $1\frac{3}{9}$

The correct answer is C.

**37** [A] [B] [C] [D]

**38** [A] [B] [C] [D]

**39** [A] [B] [C] [D]

**40** [A] [B] [C] [D]

In the set of boxes numbered **39**, the box with letter **C** printed in it is marked.

11. Your **dark line MUST BE** within the box.
12. For each question **ONLY ONE** box is to be marked in each set of four boxes.

**This question paper consists of 7 printed pages.**

*Email: [stega.printers@gmail.com](mailto:stega.printers@gmail.com)*

1. Write seven million, four hundred and two thousand and five thousands in symbols

- A. 7402000.005
- B. 7402000.5000
- C. 74020005000
- D. 7042000.005

2. What is the total value of digit 1 obtained after working out:  $0.420714 \div 0.7$ ?

- A. 0.0001
- B. 0.001
- C. 0.01
- D. 0.1

3. Salat was admitted in Nairobi hospital on 8<sup>th</sup> June 2012 and discharged on 11<sup>th</sup> November 2012. For how many days was he in the hospital?

- A. 158
- B. 157
- C. 156
- D. 155

4. What is the sum of the next two numbers in the pattern below? 4, 6, 12, 22, 36, \_\_\_\_\_, \_\_\_\_\_

- A. 128
- B. 134
- C. 126
- D. 130

5. The table below shows the attendance of pupils in a certain class in one week?

Day	MON	TUE	WED	THUR	FRI
No. Of Pupils	46	41	46	45	42

If the class has 50 pupils altogether, what was the average number of pupils absent during the week?

- A. 44
- B. 10
- C. 6
- D. 30

6. The diagonal of a rectangular plot of land measures 150m while the width measure 120m. What is the perimeter of the plot?

- A. 540m
- B. 90m
- C. 480m
- D. 420m

7. The figure drawn below shows a container filled with water to the level shown. How many more decilitres of water are required to fill the container?

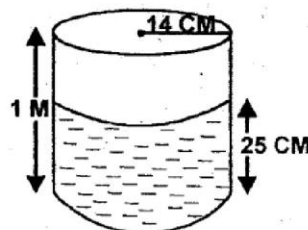

- A. 462 dl
- B. 46200 dl
- C. 46.2 dl
- D. 154 dl

8. The sum of three consecutive numbers is 84. Find the square of the largest number.

- A. 784
- B. 841
- C. 729
- D. 29

9. A bicycle wheel has a radius of 42 cm. If it made 200 revolutions, what distance did it cover in metres?

- A. 264m
- B. 52800m

C. 24400m

D. 528m

10. An empty pick up weighs 1.6 tonnes. It weighs 8.1 tonnes when loaded with 50kg bags of cement. How many bags of cement are on the lorry?

A. 130

B. 152

C. 150

D. 132

11. Work out:-  $\frac{16+24 \div 6 \times 12-4}{2 \times 36 \div 6}$

A. 4

$2 \times 36 \div 6$

B. 5

C.  $6\frac{1}{3}$

D. 64

12. 12 men can do a piece of work in 9 days. How many more men are needed to do the same piece of work in 6 days?

A. 18

B. 7

C. 6

D. 8

13. Find the area of the figure below in hectares

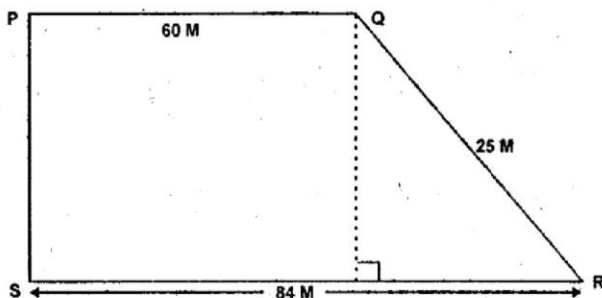

A. 0.18 ha

B. 0.504 ha

C. 0.24 ha

D. 0.0504 ha

14. By selling a T.V for sh 27000, a trader makes a 10% loss. At what price should he sell the T.V to make a profit of 10%

A. sh 24300

B. sh 33000

C. sh 30,000

D. sh 29700

15. A section of a road 7.5 km long was drawn on a map. If its length on the map is 5cm, what is the scale used?

A. 1:1500000

B. 1:15000000

C. 1:150000

D. 1:15000

16. The mass of Terry was 120kg. He fell sick and the mass decreased by 10%. A week later it decreased by another 10%. What was his final mass?

A. 96 kg

B. 108 kg

C. 97 kg

D. 97.2 kg

17. Kamunyu left his home at 8.45 am and drove towards a town which was 14.4 km away. He reached the town at 9.05 a.m. What was his average speed in m/s?

A. 12 m/s

B.  $1\frac{1}{2}$  m/s

C.  $12\frac{1}{2}$  m/s

D.  $10\frac{2}{5}$  m/s

18. The height of an isosceles triangle is 7cm. Each of the two equal sides measures 25cm. What is the area of the triangle?

A.  $336\text{cm}^2$

B.  $168\text{cm}^2$

C.  $84\text{cm}^2$

D.  $175\text{cm}^2$

19. Calculate the total surface area of the figure below.

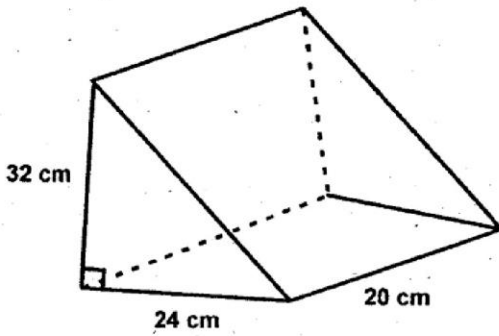

- A.  $2208\text{cm}^2$   
 B.  $1248\text{cm}^2$   
 C.  $2304\text{cm}^2$   
 D.  $2688\text{cm}^2$
20. A factory packed a total of 18944 packets of washing powder. Out of these, 5048 were  $\frac{1}{4}$  packets, 4820 were 1kg packets, 4921 were  $\frac{1}{2}$  kg packets. 2 kg packets were 785 less than 1kg packets while the rest were 5kg packets. How many kg packets were there?
- A. 120  
 B. 1200  
 C. 18824  
 D. 3370
21. What is the value of  $^3\sqrt{\frac{3}{5}(3\frac{3}{4} + 2\frac{1}{2})^{-3}\sqrt{\frac{1}{8}} \div \frac{1}{4}}$ ?
- A.  $2\frac{1}{4}$   
 B.  $14\frac{5}{8}$   
 C.  $1\frac{1}{4}$   
 D.  $13\frac{1}{2}$
22. James borrowed sh 20000 from a bank that charged simple interest at the rate of  $12\frac{1}{2}\%$  p.a. If he paid the money after 18 months, how much money did he pay to the bank altogether?
- A. sh 3750  
 B. sh 45000  
 C. sh 23750  
 D. sh 23600

23. Ken and John shared some money in the ratio 4:5 respectively. John got sh 36 more than Ken. How much money did Ken get?
- A. sh 180  
 B. sh 4  
 C. sh 144  
 D. sh 324
24. Draw triangle ABC where  $AB=7\text{cm}$ ,  $BC=6\text{cm}$  and angle  $ABC = 70^\circ$ . Draw a circle to touch the vertices of the triangle. What is the diameter of the circle?
- A. 6.5 cm  
 B. 7.6 cm  
 C. 8.2 cm  
 D. 5.4 cm
25. Mwakio bought the following items from a shop:-  
 2 packets of unga @ sh 47.00  
 2 kg of cooking fat for sh 560  
 $1\frac{1}{2}$  kg of rice @ sh 66.00  
 2 kg of sugar @ sh 65.00  
 If she paid the items with a one thousand shilling note how much more should she have added the shopkeeper in order to receive a balanced of sh 200?
- A. sh 117  
 B. sh 883  
 C. sh 93  
 D. sh 83
26. Otieno slept at 2130 hrs and woke up at 6.05 a.m the following day. For how long did he sleep?
- A. 8hrs 35 min  
 B. 9hrs 35 min  
 C. 15 hrs 25 min  
 D. 3 hrs 25 min
27. Work out the value of K in:
- $$\frac{3k + 4 - \frac{1}{2}}{2} = 3$$



- A.  $\frac{1}{2}$
- B. 1
- C. 4
- D. 5

28. In the figure below, line ABC is a straight line, EF is parallel to BC. Angle DBA =  $122^\circ$ . While angle EFC =  $118^\circ$ . Find the value of the angle marked t.

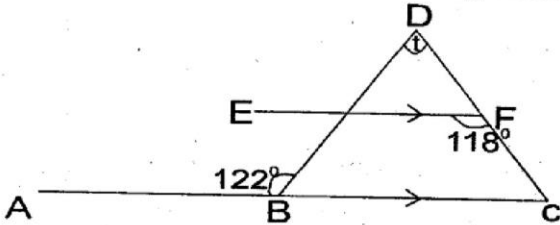

- A.  $44^\circ$
- B.  $60^\circ$
- C.  $58^\circ$
- D.  $62^\circ$

29. Which of the following groups of numbers is made up of prime numbers only?

- A. 51, 87, 43, 31
- B. 97, 91, 79, 67
- C. 5, 7, 11, 57
- D. 53, 61, 71, 83

30. What percentage of the figure below is shaded?

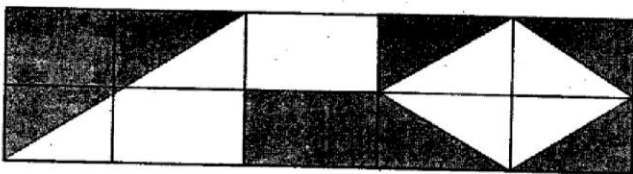

- A. 50%
- B. 30%
- C. 75%
- D. 25%

31. Write  $3\frac{1}{2}$  as a ratio in the simplest form

- A. 7:2

- B. 2:7
- C. 7:200
- D. 200:7

32. What is the square root of 0.021904?

- A. 1.48
- B. 0.148
- C. 148
- D. 0.0148

33. What is the value of  $43.47 \div 6$  correct to 2 decimal places?

- A. 7.25
- B. 7.24
- C. 7.20
- D. 7.30

34. The angles of a triangle are  $4(p+5^\circ)$ ,  $10p$  and  $6(p-5^\circ)$ . What kind of triangle is it?

- A. Right angled
- B. Isosceles
- C. Equilateral
- D. Scalene

35. The diagram below is a wooden box used for packing circular tins. The tins have a diameter of 0.28m and a height of 0.4m

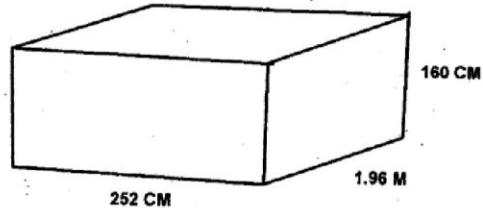

How many such tins can be packed in the box?

- A. 360
- B. 225
- C. 522
- D. 252

36. The table below shows the sizes of shoes and the number of pairs sold in a shop in one day.

Size of shoe	2	3	4	5	6
No. Of Pairs Sold	8	12	16	22	6

Which size of shoes had the modal size?

- A. 6
- B. 5
- C. 4
- D. 22

37. A rope 1584 cm long goes round a cylindrical tank exactly nine times. What is the diameter of the tank?

- A. 28cm
- B. 72cm
- C. 56cm
- D. 504cm

38. In the figure below GHIJ is a rhombus. Line JH is a diagonal, line HI = line HL while  $\angle GJH = 40^\circ$

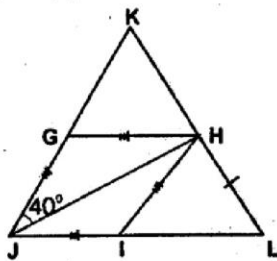

What is the size of  $\angle GKH$ ?

- A.  $60^\circ$
- B.  $80^\circ$
- C.  $40^\circ$
- D.  $20^\circ$

39. A farmer harvested 10080 bags of potatoes in 2014. This was a 20% decrease in harvest from the harvest for 2013. How many bags of potatoes had he harvested in 2013?

- A. 2016
- B. 8064
- C. 12600

D.12096

40. The hire -purchase price of a bicycle is sh 5400. Ian bought it by paying a deposit of sh 2000. He paid the rest in instalments of sh 340 each starting in the month of May. In which month was the last instalment paid?

- A. February
- B. December
- C. March
- D. January

41.  $\frac{4}{5}$  of a number is 15 more than three-quarter of it. What is the number?

- A. 400
- B. 100
- C. 300
- D. 200

42. Two and half tonnes of sugar was packed in small packets each weighing 500g. How many packets were used?

- A. 200
- B. 5000
- C. 50
- D. 500

43. Kariuki's house is 12.6 m long and 9m wide. He is to cover the floor with tiles 18cm by 15 cm each. How many tiles does he need?

- A. 4200
- B. 2100
- C. 420
- D. 42

44. The mean age of 54 pupils in a certain class is 13 years. When the mass of their class teacher is included, the mean age becomes  $13\frac{2}{5}$  years. What is the class teacher's age?

$36 \div 4 + 6 \times 4 \div 2 = ?$

- A. 55 yrs
- B.  $21\frac{1}{2}$  yrs
- C.  $18\frac{1}{5}$  yrs
- D. 35 yrs

45. The pie chart below shows the number of fruits that were sold by a certain grocer in Kigumo market

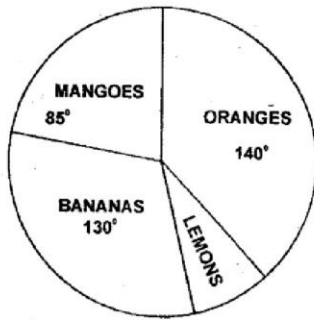

If the grocer sold 45 lemons, how many more oranges than bananas were sold?

- A. 165
- B. 10
- C. 30
- D. 90

46. Work out  $4t + 4 - t + 2 < 7$

- A.  $t > 3$
- B.  $t < 3$
- C.  $t < \frac{1}{3}$
- D.  $t > \frac{1}{3}$

47. Construct triangle ABC in which  $BC = 9\text{cm}$  and  $\angle ABC = 45^\circ$  and angle  $\angle BCA = 60^\circ$ . Measure line AC

- A. 5cm
- B. 6.6cm
- C. 3.3cm
- D. 2.9 cm

48. Njoroge spends  $\frac{4}{7}$  of his salary on food,  $\frac{3}{4}$  of the remainder on rent and the rest on savings. If he saves sh 900, how much does he use on food and rent?

- A. sh 7500
- B. sh 4800
- C. sh 2700
- D. sh 8400

49. The temperature of a mass of ice is  $-14^\circ\text{C}$ . What will be the reading on the thermometer if there is a rise of  $69^\circ\text{C}$ ?

- A.  $55^\circ\text{C}$
- B.  $83^\circ\text{C}$
- C.  $75^\circ\text{C}$
- D.  $73^\circ\text{C}$

50. The graph below shows a ten days journey and the distance cycled on each day.

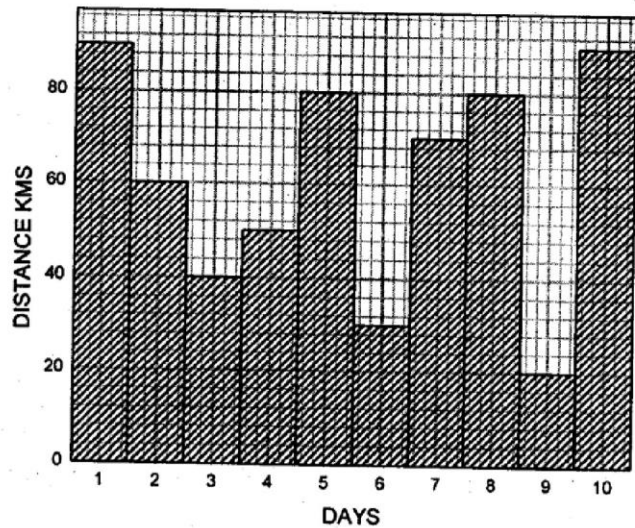

By how many kilometers is the journey made in the last four days more than the journey made in the first four days?

- A. 500 km
- B. 610 km
- C. 400 km
- D. 20 km

Study the map of Rapenda Area and answer questions 1 to 7.

RAPENDA AREA

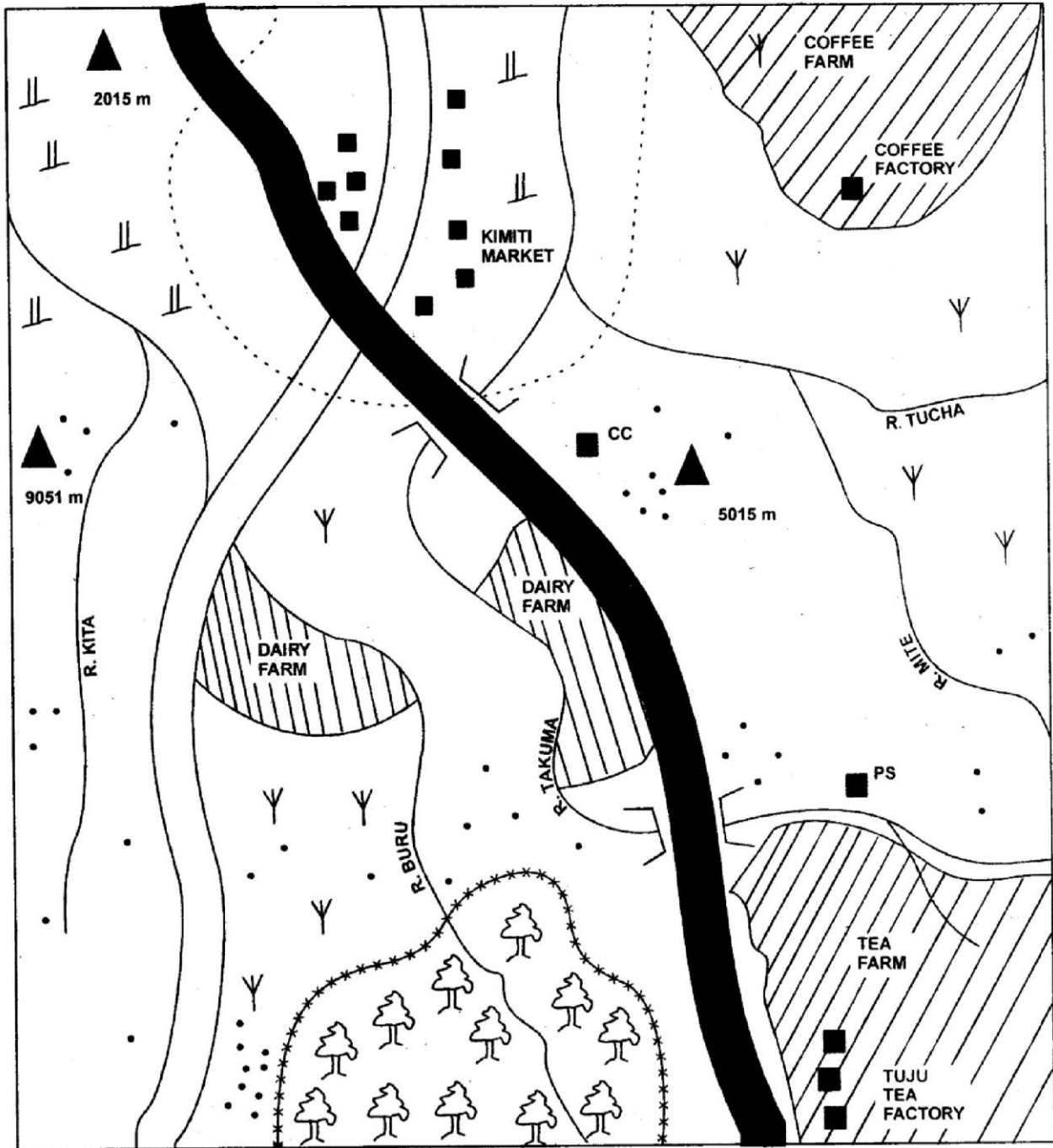

KEY

■	PERMANENT BUILDINGS	🌲	FOREST
•	SETTLEMENT	▲	HILL
⋯	URBAN COUNCIL	▬	TARMAC ROAD
⋈	FOREST BOUNDARY	▬	MURRAM ROAD
	SCRUB	PS	POLICE STATION
Y	WOODLAND	CC	CHIEF'S CAMP

1. The highest point in Rapenda area is found to the
  - A. West
  - B. North west
  - C. North East
  - D. Central
  
2. What is the direction of the tea factory from Kimiti market?
  - A. South East
  - B. South West
  - C. North East
  - D. North West
  
3. The main economic activity in South Eastern part of Rapenda area is?
  - A. cash crop farming
  - B. beef farming
  - C. mining
  - D. fishing
  
4. The type of soil in the North Eastern part of Rapenda area is
  - A. Alluvial
  - B. Sandy
  - C. Loamy
  - D. Volcanic
  
5. What evidence in the map shows North western part of Rapenda area receives low rainfall?
  - A. Existence of settlements
  - B. presence of hills
  - C. presence of scrub vegetation
  - D. existence of forests
  
6. Which one of the following breed of animals are most likely to be found in the dairy farm in Rapenda area?
  - A. Guernsey
  - B. Zebu
  - C. Sahiwal
  - D. Boran
  
7. What evidence on the map shows that there is likely to be security in Rapenda area?

- A. Chief camp
- B. Settlement
- C. Police station
- D. Rivers

8. Which one of the following communities in Kenya compromise of Highland Nilotes only?

A

B

Turkana Iteso Pokomo
----------------------------

Dawida Ameru Abagusii
-----------------------------

C

D

Marakwet Sabaot Tugen
-----------------------------

Agikuyu Rendile Somalia
-------------------------------

9. In which month is the sun in the Southern Hemisphere?
  - A. March
  - B. December
  - C. September
  - D. June
  
10. Which one of the following mountains was formed as a result of folding?
  - A. Mount Elgon
  - B. Mount kilimanjaro
  - C. Ruwenzori mountains
  - D. Cape Ranges
  
11. Which one of the following rivers does NOT form a boundary between two countries?
  - A. River Zambezi
  - B. River Kagera
  - C. River Tana
  - D. River Ruvuma

*Study the diagram below and use it to answer questions 12*

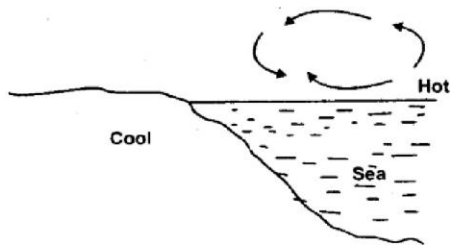

12. The diagram above illustrates the formation of a
- Land breeze
  - Sea breeze
  - Ocean cool currents
  - Warm ocean currents
13. Which one of the following African countries was the last to attain independence?
- Ghana
  - Zimbabwe
  - Kenya
  - Tanzania
14. French beans are exported from Kenya to the markets in Britain mainly through
- water transport
  - air transport
  - railway transport
  - road transport
15. Which one of the following groups of commodities did the Maasai obtain from the Akamba during the pre-colonial days?
- red ochre and skins
  - hoes and grains
  - milk and honey
  - wood carvings and grains
16. In Kenya external enemies are prevented from entry by
- National Youth Service
  - Prisons Department
  - National Police
  - Kenya Defence Forces
17. The process that formed most mountains in Eastern Africa is ?

- Faulting
- Folding
- Volcanicity
- Erosion

18. Among the Ameru, people who were initiated together formed
- a clan
  - a sub-tribe
  - a generation
  - an age set
19. The political party that led Ghana to independence was formed in the year \_\_\_\_\_
- 1951
  - 1949
  - 1948
  - 1961
20. The cheapest method of preserving fish is by use of
- salt
  - ice
  - fire
  - sun
21. Sheet erosion can best be controlled by
- crop rotation
  - mulching
  - planting grass
  - building gabions
22. Which one of the following cash crops is commonly grown in South Sudan?
- cloves
  - cocoa
  - sugar cane
  - tea
23. Which one of the following statements is true about beef farming in Kenya? Beef farmers
- carry it along the river Tana valley
  - use natural pasture to feed their animals

- C. A sling and two stones  
D. A sling and one stone
67. King Solomon was against God's will by  
A. signing treaties with foreign countries  
B. marrying many wives  
C. building the Temple of God  
D. allowing the worship of foreign gods in Israel
68. Which main lesson do we learn from the incidence when Gideon went to fight Midianites with only 300 men?  
A. we should be proud of ourself  
B. God works with many people  
C. God doesn't work with the number  
D. we should depend on our own abilities
69. Who among the following prophets prophesied that Jesus will be born by a virgin lady?  
A. Isaiah  
B. Micah  
C. Ezekiel  
D. Jeremiah
70. The main lesson christians learn from the announcement of the birth of Jesus and John the Baptist is that they should  
A. be prayerful  
B. be humble before God  
C. be ready to do God's work  
D. Trust in God power
71. King Herod wanted to kill baby Jesus because  
A. Jesus was born in a poor Bethlehem  
B. Jesus was born in a poor family  
C. He feared that Jesus would become famous  
D. Feared that Jesus would be a well known person
72. From the parable of the pharisees and the tax collector christians learns to  
A. be persistent in prayer  
B. be prayerful  
C. use their wealth wisely  
D. be humble and genuine when praying
73. The son of man is the Lord of the Sabbath. (Luke 6:5) These words were spoken by Jesus when He  
A. calmed the storm  
B. healed a paralysed man  
C. visited Mary and Martha at Bethany  
D. healed a woman with the flow of blood
74. Jesus turned water into wine at Cana of Galilee mainly because  
A. he was told by His mother  
B. people were hungry  
C. he had started his ministry  
D. he wanted to be famous
75. The main reason why Jesus was rejected by the Jewish people was  
A. eating with unclean hands  
B. He mixed freely with sinners  
C. He healed on the Sabbath  
D. He claimed to be Messiah
76. Jesus asked his disciples to pray on Mt Olive because he wanted them to  
A. stay awake  
B. avoid falling into temptation  
C. save him from his enemies  
D. go with him to Pilate
77. The disciples received the Holy spirit on the day of the Pentecost, at \_\_\_\_\_  
A. Galilee  
B. Jerusalem  
C. Judea  
D. Bethlehem
78. During the stoning of Stephen, \_\_\_\_\_ approved his death  
A. Paul and Silas  
B. Barnabas



- C. Saul  
D. Jews
79. During the conversion of Saul, the persecuter, he was on his way to \_\_\_\_\_  
A. Jerusalem  
B. Damascus  
C. Jericho  
D. Mesopotamia
80. According to St Paul's teaching, a christian should love his wife as much as:  
A. Christ loved the church  
B. He loves his friend  
C. His wife loves him  
D. Christ loves the world
81. In Traditional African Communities, people showed that God is holy mainly by  
A. punishing offenders  
B. worshipping him  
C. telling stories about Him  
D. obeying religious specialists
82. Which one of the following teachings from the creation stories is found in both Christians and Traditional African Communities? Human beings  
A. were created on the Sixth day  
B. were created in the image of God  
C. should take care of creation  
D. are God
83. Shedding blood during initiation in some Traditional African Communities meant  
A. strong and healthy  
B. being ready to lead  
C. being separated  
D. being united to the ancestors
84. The main reason why people shared things in Traditional African Communities was because they wanted to  
A. become famous  
B. show concern  
C. show unity  
D. obey ancestors
85. Which of the following activities by Christians today is an example of the gifts of holy spirit?  
A. reading the bible  
B. collecting offerings  
C. cleaning the church  
D. singing in the choir
86. As Christians, which one of the following is the best advice to a person living with HIV/AIDS?  
A. Avoid sharing food  
B. Do not donate blood  
C. Do not greet others  
D. Avoid sitting close to others
87. Boaz, a standard seven pupil finds two Std three pupils fighting on their way home. As a christian, what should Boaz do?  
A. stop them from fighting  
B. leave them fighting  
C. report to the teacher  
D. tell them to go home
88. Carol your friend is given money to buy a pen but she plans to buy sweets instead. As a christian, what is the best advice to give her?  
A. buy sweets and share  
B. buy sweets another time  
C. share the money with the friends  
D. follow the instructions given
89. Okoyo a class 6 pupil finds out that his friend Emondo has not been doing her morning duties. As a christian, what should Okoyo do about it?  
A. report to class teacher  
B. report her to her parents  
C. tell her to be responsible  
D. do the work for her
90. The main reason why christian missionaries came to Kenya was to  
A. introduce Western Education  
B. stop slave trade  
C. spread the word of God  
D. stop female circumcison

- C. uses fodder crops mainly to feed their livestock  
D. own small pieces of land
24. In Kenya, parliamentary sessions are officially opened by  
A. The speaker of the National Assembly  
B. The speaker of the senate  
C. The clerk of the senate  
D. The head of the state
25. The largest inland port in Eastern Africa is \_\_\_\_\_  
A. Mombasa  
B. Dare salaam  
C. Kisumu  
D. Bukoba
26. For one to qualify to vie for membership of the County Assembly, one must be  
A. Twenty one years and above  
B. Eighteen years and above  
C. Thirty five years and below  
D. Fifty five years and below
27. Which one of the following factors influence the climate of a place?  
A. High population  
B. Food crops  
C. Prevailing winds  
D. Permanent rivers
28. The main function of the school committee in Kenya's public primary schools is to  
A. employ all the teachers  
B. promote hard working teachers  
C. expel indiscipined learners  
D. maintain the tradition of the school
29. The Nandi rebellion in Kenya was led by  
A. Lenana  
B. Samoci  
C. Kinnyole  
D. Mukite
30. Which one of the following is a characteristic of Mediteranean climate of Africa?  
A. The area receives rainfall in Summer  
B. The area receives rainfall in Winter  
C. The area has high temperatures all the year round  
D. A lot of rain falls in the afternoon
31. If the time in Kajiado 60°E is 3.00 am, what is the longitude of Masaka if the time there is 1.00am?  
A. 15° E  
B. 15°W  
C. 30°E  
D. 30 W
32. Which one of the following is a responsibility of children in a home?  
A. playing all the time  
B. caring for the parents  
C. providing the basic family needs  
D. Helping in the house chores
33. Which one of the following countries in Africa is not a member of COMESA?  
A. Malawi  
B. Tanzania  
C. Uganda  
D. Ethiopia
34. The diagram below shows a weather measuring instrument

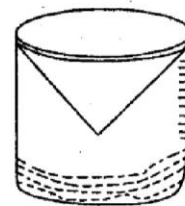

- The instrument shown is marked in units called  
A. Millilitres  
B. Millimeters  
C. Litres

D. Degrees celcius

Use the map of Africa below to answer questions 35 to 38



35. The true statement about the lake marked P is that
- A. it is the source of river Nile
  - B. it is found in the floor of the Rift Valley
  - C. it is a home of flamingoes
  - D. it was formed through down warping
36. The ocean current marked Q
- A. causes high rainfall in the North Western part of Africa
  - B. raises temperature in the mediterranean lands
  - C. is a cool ocean current
  - D. is a warm ocean current
37. Which one of the following types of climate is experienced in the area marked T?
- A. Mediterranean climate
  - B. Desert climate
  - C. Equatorial climate
  - D. Savana climate
38. The river marked W is
- A. Limpopo
  - B. Zambezi
  - C. Orange
  - D. Cunene

39. Which one of the following horticultural crops is mainly grown for export in the Mwea Tebere irrigation scheme?
- A. Onions
  - B. French beans
  - C. Pineapple
  - D. Tomatoes
40. The lake Victoria basin in Eastern Africa have high population density because
- A. the soils are fertile
  - B. there is enough land for settlements
  - C. there is reliable rainfall
  - D. there is a warm climate
41. The main reason why bananas are widely grown in Central Uganda is that it is
- A. grown as a fodder crop
  - B. the people's staple food
  - C. exported to earn foreign exchange
  - D. cheap to produce
42. The main source of revenue for the National Government in Kenya is
- A. income tax
  - B. loan
  - C. Excise duty
  - D. grants
43. Which one of the following courts in Kenya is the lowest?
- A. High court
  - B. Supreme court
  - C. Court of appeal
  - D. Chief Magistrates Court
44. The diagram below represents a type of a mountain.

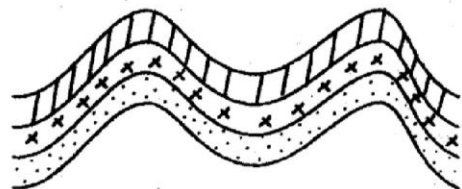

The type of mountain represented in the diagram above was formed as a result of

- A. Erosion
  - B. Faulting
  - C. Folding
  - D. Volcanicity
45. Which one of the following statements about a clan in the Maasai traditional society is true?
- A. They were founded by women
  - B. They were formed by people who were initiated almost at the same time
  - C. They were made up of famous rain makers
  - D. They created kinship in the society
46. Which one of the following factors mainly determines the location of a cement manufacturing industry?
- A. nearness to raw material
  - B. nearness to the market
  - C. availability of transport
  - D. availability of labour
47. Which one of the following is NOT a contribution of minerals to the economy of Kenya?
- A. Provides employment
  - B. Leads to growth of towns
  - C. Leads to growth of slums
  - D. Leads to provision of good transport and communication
48. A duty performed by the Ameru council of elders during the pre colonial period was
- A. leading hunting expeditions
  - B. controlling trade
  - C. distributing land to clan members
  - D. organising marriage ceremonies
49. Which one of the following factors mainly explains why the Marakwet migrated from their original homeland into Kenya?
- A. population pressure
  - B. search for pasture
  - C. search for fertile lands
  - D. spirit of adventure
50. Which one of the following is elected to represent a county in the legislative arm of government?
- A. member of parliament
  - B. governor
  - C. member of county assembly
  - D. senator
51. Which one of the following methods is used to mine Soda ash in Lake Magadi in Kenya
- A. deep shaft method
  - B. evaporation
  - C. dredging
  - D. open cast
52. Which among the following crops was introduced by the Europeans into Kenya?
- A. millet
  - B. tea
  - C. sorghum
  - D. arrow roots
53. The type of soil erosion commonly experienced on flat ground is \_\_\_\_\_
- A. splash erosion
  - B. gully erosion
  - C. rill erosion
  - D. sheet erosion
54. Which one of the following Africa Traditional Societies lived in small group of families before the coming of the Europeans?
- A. The San
  - B. The Khoikhoi
  - C. Soninke
  - D. Abawanga
55. The method of colonial administration used by the portuguese in Mozambique was

- A. direct rule
  - B. paternalism
  - C. indirect rule
  - D. assimilation
56. Trees with numerous climbing plants is a characteristic of natural vegetation found in the
- A. Savana climate
  - B. Mediterranean climate
  - C. Equatorial climate
  - D. Mountain climate
57. Who among the following African traditional leaders resisted the establishment of German Colonial rule?
- A. Lewanika
  - B. Chief Mkwawa
  - C. Koitalel
  - D. Kabaka Mwanga
58. Which one of the following leaders was a founder member of the East African Community in 1967?
- A. Hail Sellassie
  - B. Julius Nyerere
  - C. Daniel Moi
  - D. Oginga Odinga
59. Which one of the following national government officers mainly explains the policy of the government to the citizens?
- A. Police officer
  - B. Attorney General
  - C. Assistant county commissioner
  - D. Prison officer
60. The main tourist attraction in Zimbabwe are
- A. Shona ruins
  - B. Gexli ruins
  - C. Great pyramids
  - D. Sandy beaches

## SECTION A

### CHRISTIAN RELIGIOUS EDUCATION

61. From Genesis story of creation, the name 'Eve' means
- A. The mother of all human kind
  - B. unreliable
  - C. Man's companion
  - D. Out of man
62. The main reason why Noah built an ark was to make him able to:-
- A. hide his family
  - B. worship God there
  - C. fulfil God's wish
  - D. be righteous and faithful
63. Who among the following people is the father of the jews?
- A. Moses
  - B. Abraham
  - C. Adam
  - D. Jacob
64. "I won't, unless you bless me," Jacob answered. "What is your name?" the man asked. "Jacob," he answered. These words were said to Jacob when he was at
- A. Bethel
  - B. Canaan
  - C. Desert
  - D. Peniel
65. God made Israelites to wonder in the wilderness mainly because:-
- A. Canaan was very far
  - B. Israelites were not faithful to God
  - C. Israelites got tired on their way
  - D. God wanted to punish them
66. In 1 Samuel 17:40, David killed Goliath using
- A. A sling
  - B. A sling and five stones

**SECTION B**  
**ISLAMIC RELIGIOUS EDUCATION**

61. Which surah of the Quran promises the prophet (AS) a river in paradise?  
A. Maun  
B. Quraish  
C. Kauthar  
D. Fiyl
62. Which angel of Allah (SAW) brought the Quran to the prophet Mohammad (SAW)?  
A. Mikail  
B. Izrafil  
C. Izrail  
D. Jibril
63. Which one of the following activities is not associated with Aqiqah?  
A. Praying for the dead  
B. Slaughtering an animal  
C. Circumcision  
D. Naming
64. Who was the wife of Nabii Adam(as)  
A. Maryam  
B. Hajar  
C. Hawa  
D. Aisha
65. The mixing of good and bad quality goods is called  
A. Ghush  
B. Hoarding  
C. Interest  
D. usury
66. All fardh prayers are compulsory for muslims. the shortest fardh prayer is  
A. Asr  
B. Dhuhur  
C. Fajr  
D. Maghrib
67. The attribute of Allah "RAHIM" means  
A. Beneficent  
B. Merciful  
C. Creator  
D. Truth
68. In surah Al-Qadr Ruh refers to  
A. Malaika  
B. Jibril  
C. Ridhwan  
D. Izrail
69. The verse of throne is found in surah  
A. Al-Baqarah  
B. Nas  
C. Falaq  
D. Al-Ikhlis
70. In which month do we have lailatul Qadr?  
A. Ramadhan  
B. Rajab  
C. Swafar  
D. Yasin
71. The main source of Islamic law is the  
A. Quran  
B. Sunnah  
C. Hadith  
D. Ijma
72. \_\_\_\_\_ was the first successor to the prophet  
A. Abubakar  
B. Umar  
C. Ali  
D. Uthman
73. The attendant of Nabii Musa(AS) was \_\_\_\_\_  
A. Khidhr  
B. Harun  
C. Yushaa  
D. Isa
74. Eid ul Fitri is celebrated in the month of \_\_\_\_\_  
A, Shawwal  
B. Rajab  
C. Swafar  
D. Shaban
75. Which surah is recited in every prayer?  
A. Falaq  
B. Fatiha  
C. An Nas  
D. Lahab



76. Who was the first person to receive guidance from God?  
 A. Adam  
 B. Yunus  
 C. Nuh  
 D. Ibrahim
77. Ashura takes place on the \_\_\_\_\_ of muharram  
 A. 1<sup>st</sup>  
 B. 10<sup>th</sup>  
 C. 27<sup>th</sup>  
 D. 25<sup>th</sup>
78. The attribute mentioned in surah Ikhlas is \_\_\_\_\_  
 A. Judge  
 B. Powerful  
 C. Forgiving  
 D. Eternal
79. The prophet preached islam secretly for \_\_\_\_\_ years  
 A. 5  
 B. 4  
 C. 2  
 D. 3
80. Which holy book was revealed to Daud  
 A. Taurat  
 B. Quran  
 C. Zabur  
 D. Inji
81. Abulahab was \_\_\_\_\_ of the prophet  
 A. An uncle  
 B. Acousin  
 C. Father  
 D. Brother
82. Yathrib is one of the names of the city of \_\_\_\_\_  
 A. Mecca  
 B. Medina  
 C. Yemen  
 D. Egypt
83. \_\_\_\_\_ means the day of clamour  
 A. Zilzalah  
 B. Lahab  
 C. Al- Qaariah  
 D. Al-kauthar
84. How many goats are slaughtered during the Aqiqa of a baby girl?  
 A. Two  
 B. Three  
 C. One  
 D. Four
85. The night of power is better than \_\_\_\_\_ months  
 A. 100  
 B. 500  
 C. 1000  
 D. 1500
86. The Qibla of muslims is in \_\_\_\_\_  
 A. Makka  
 B. Maedina  
 C. Palestine  
 D. Syria
87. The angel who brings rain is called \_\_\_\_\_  
 A. Mikail  
 B. Jibril  
 C. Ridhwan  
 D. Israil
88. We ask Allah's protection in surah \_\_\_\_\_  
 A. Nasr  
 B. Falaq  
 C. Ikhlas  
 D. Kauthar
89. Tawakul mean \_\_\_\_\_  
 A. Fear of Allah  
 B. Belief in Allah  
 C. Trust in Allah  
 D. Pray to Allah
90. Which islamic month come just before Rajab?  
 A. Jamadhul  
 B. Shaban  
 C. Safar  
 D. Shawal



- Fertilization in human beings takes place in the?
  - uterus
  - ovary
  - oviduct
  - cervix
- A patient had the following signs and symptoms:
  - severe stomachache*
  - feeling weak and dizzy*
  - violent vomiting*
  - Diarrhoea*
 Which of the following diseases was he suffering from?
  - Malaria
  - Cholera
  - Bilharzia
  - Typhoid
- Which one of the following simple tools has the position of the load, effort and fulcrum in the same positions as a spade?
  - wheel barrow
  - claw hammer
  - spiral stairs
  - fishing rod
- Which of the following pairs of liquids can be separated by decanting?
  - Water and spirit
  - Alcohol and water
  - Ink and paraffin
  - Diesel and petrol
- Which component of air can be used in the preservation of soft drinks?
  - Carbon dioxide
  - Oxygen

- Rare gases
- Nitrogen

- The following are adaptive characteristics of mammals. Which one is NOT?
  - Presence of a horny pad on the upper jaw in some herbivores
  - Shedding off of teeth to allow the permanent ones to grow
  - Presence of diastema in herbivores
  - Molars with ridged surfaces
- A pupil put a plastic ruler in a glass of water as shown below:

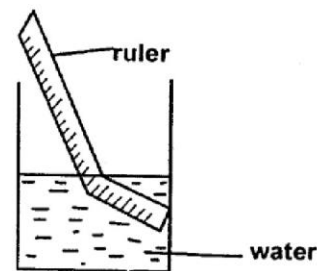

The ruler appeared bent because

- of refraction of light
  - light does not need a medium of transmission
  - air is heavier than water
  - light is split into several colours
- Which one of the following is NOT a sexually transmitted infection?
    - Gonorrhoea
    - Syphilis
    - Chancroid
    - Bilharzia
  - Which one of the following shows the correct order of development of a fertilised egg?
    - Zygote → Foetus → Embryo → Baby

B. Embryo → Zygote → Foetus → Baby

C. Zygote → Embryo → Foetus → Baby

D. Foetus → Zygote → Embryo → Baby

10. Which one of the following practices will **NOT** pollute the air?
- A. Tobacco smoking
  - B. Emission from vehicles exhaust pipes
  - C. Burning vegetation cover
  - D. Controlling weeds by use of herbicides
11. Which of the following is **NOT** a sign of unhealthy crops?
- A. Stunted growth
  - B. Low yields
  - C. Curled leaves
  - D. Discoloured leaves
12. The **BEST** meal for a lactating mother should be
- A. rich in fibre and water only
  - B. fried and not steamed or boiled
  - C. more of carbohydrates than proteins
  - D. rich in calcium and phosphorus
13. Which of the following practises **cannot** help in conserving soil?
- A. Ploughing across the contours
  - B. Planting trees on hilly areas
  - C. Digging of terraces
  - D. Applying mulches
14. Which one of the following groups of animals have moist skin, breathe by means of lungs and lays eggs in water?
- A. Tilapia, salamander, lizard
  - B. Frog, newt, toad

C. Chameleon, lizard, trout

D. Spiny-ant eater, tilapia lizard

15. Acid rain is usually formed when rain water mixes with
- A. Carbon monoxide and Sulphur monoxide
  - B. Sulphur monoxide and Carbon monoxide
  - C. Sulphur dioxide and Carbon dioxide
  - D. Sulphur dioxide and Carbon monoxide
16. The rollers used when moving a heavy load help in
- A. making the load more streamlined
  - B. reducing the amount of work to be done
  - C. increasing the surface in contact
  - D. reducing the force that opposes motion
17. Which one of the following adaptations helps both birds and fish in movement?
- A. webbed feet
  - B. good eye sight
  - C. streamlined body
  - D. presence of fins
18. Below is a diagram of a simple circuit

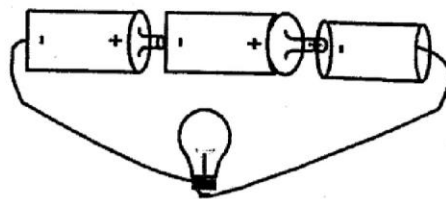

- Which one of the following statements is **true** about the circuit?
- A. The bulb did not light
  - B. The bulb lit dimly
  - C. The bulb blew up
  - D. The bulb kept blinking

19. Which one of the following is **NOT** advisable while handling electricity?
- Fitting of lighting arresters on tall buildings
  - Do not overload sockets
  - Switching off lights with dry hands
  - Inserting wires in the sockets
20. Which one of the following is **NOT** a commended way of controlling crop pests?
- Scaring
  - Hand picking
  - Poisoning
  - Pruning
21. Blood that flows into the right auricle of the heart is carried by the
- aorta
  - venacava
  - pulmonary artery
  - pulmonary vein
22. A pupil dropped pieces of paper above an open fire. Which of the following statements is **TRUE** about what was observed?
- The papers fell in the open fire and got burned
  - Convectional currents in the air blew them upwards
  - Radiation of heat carried the papers away
  - The weight of cold air helped in blowing the papers upwards
23. Clouds which have flat bases are also known to be
- moutainous
  - dark grey
  - rain bearing
  - lying low in the sky

24. Which is the sixth planet in the solar system?
- Uranus
  - Pluto
  - Neptune
  - Saturn
25. Which one of the following is a social effect of drug abuse?
- Poor health of the unborn
  - Loss of consciousness
  - Dropping out of school
  - Impaired judgement
26. Which of the following is a disadvantage of friction?
- Wearing out surfaces
  - Helps in sharpening
  - Makes movement possible
  - Enables us to clean surface
27. The diagram below shows change of state in matter



Which pair represents processes that occur due to an increase in temperature?

- Q and R
  - R and S
  - S and T
  - T and Q
28. The diagram shows an experiment done to investigate a certain property of matter

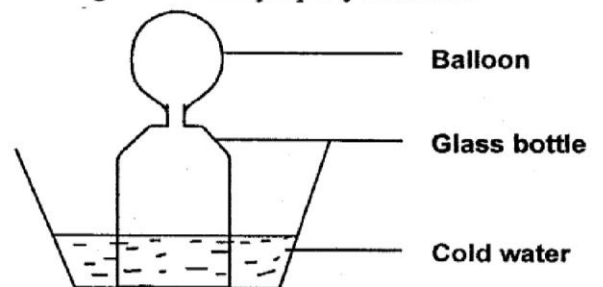

Which of the following properties of matter was being investigated?

- A. Solids contract on coolings
  - B. Liquids expand when heated
  - C. Matter exchanges its state when cooled
  - D. Gases decrease in volume when cooled
29. Which one of the following livestock parasites affects the brain of sheep?
- A. Lungworm
  - B. Roundworm
  - C. Liverfluke
  - D. Tapeworm
30. The following are disadvantages of hard water EXCEPT
- A. wasting soap during laundry
  - B. discolouring the inside of kettles
  - C. discolouring white garments
  - D. providing additional minerals to the body
31. Animals depend on plants
- A. for protection
  - B. for manure
  - C. for support
  - D. for oxygen
32. Plants that grow in wet areas have all the following adaptations **except**
- A. Flexible stems
  - B. Thin cuticles on the leaves
  - C. Waxy shiny leaves
  - D. Folded leaves
33. Which one of the following is the third stage in the process of birth?
- A. Widening of the cervix
  - B. Contraction of the uterine walls

- C. Breaking of the amnion sac
- D. Release of the after birth

34. To conserve energy by using it sparingly, one should do all the following **except**
- A. switch off lights when not in use
  - B. share transport to the same destination
  - C. use an improved jiko for cooking
  - D. construction of smooth road net-work
35. The fall of an object is caused by
- A. gravity
  - B. volume
  - C. presence
  - D. mass

36. The diagram below represents an investigation on soil

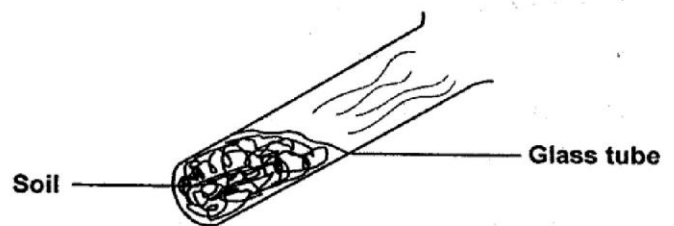

- The set up was heated gently for sometime. Which one of the following components of soil was being investigated?
- A. Air in soil
  - B. Living things in soil
  - C. Organic matter in soil
  - D. Moisture in soil
37. Which one of the following is NOT a source of electricity?
- A. Batteries
  - B. solar panels
  - C. bicycle dynamos
  - D. water dam

38. Which one of the following is NOT a factor influencing soil erosion?
- A. Slope of the land
  - B. Type of soil
  - C. Amount of rainfall
  - D. Flowing waters

39. Which one of the following animals does NOT reproduce by laying eggs?
- A. Shark
  - B. Salamandar
  - C. Whale
  - D. Ostrich

40. Hard water can easily be made soft by
- A. adding table salt
  - B. leaving in the sun to evaporate
  - C. boiling then leaving to cool down
  - D. mixing with water from other sources

41. The diagram below represents an investigation on energy.

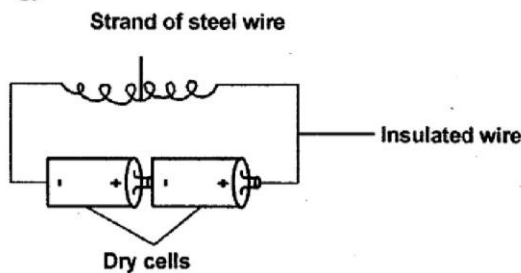

The pupils must have been investigating

- A. transformation of energy in an electromagnet
  - B. the simple lighting process of a bulb
  - C. ways of conserving electric energy
  - D. ways of generating electricity using dry cells
42. A child who easily becomes dizzy, gets tired easily, has white palms and nails should be feed on

- A. proteins such as bean and eggs
- B. carbohydrates such as cereals
- C. foods rich in iron
- D. fibre and water to help in digestion of food

43. How many incisors does a child have on the upper jaw?
- A. Two
  - B. Three
  - C. Four
  - D. Six

44. Which one of the following is NOT a common communicable disease?
- A. Tetanus
  - B. Tuberculosis
  - C. Malaria
  - D. Cholera

45. Which of the following components of blood is **correctly** matched with its functions
- A. White blood cells - helps in clotting
  - B. Red blood cells- transports hormones in the body
  - C. Plasma - transports food nutrients
  - D. Platelets - transports oxygen in the body

46. An air and a liquid thermometers were put in the same place on a hot day. Which one of the following shows what happened?

	Air Thermometer	Liquid Thermometer
A.	Level of water rose	Level of water dropped
B.	Level of water dropped	Level of water rose
C.	No change to the level	Level dropped then rose
D.	Level rose then dropped	No changes to the level

47. The following are advantages of using organic manures. Which one is **NOT**? They
- A. are bulk to transport
  - B. improve the soil structure
  - C. benefit the soil for a long time
  - D. help to restore the lost nutrients in the soil
48. Which of the following happens last during germination?
- A. Growth of the shoot
  - B. Bursting of testa
  - C. Growth of the radicle
  - D. Absorption of water
49. Where does fertilisation take place in green flowering plants?
- A. Flowers
  - B. Stigma
  - C. Ovules
  - D. Ovary
50. Which one of the following factors does **NOT** affect floating and sinking?
- A. Shape
  - B. Size
  - C. Material
  - D. Weight

Read the passage below. It contains blank spaces 1-15. Choose the best answer from the choices given.

Recent fire 1, mostly in Nairobi, have brought back the endless debate 2 Kenyans disaster preparedness. Since the year 3, the Kenya National Disaster Operational Centre, says that there have been several fire related cases which have destroyed close to thousands of household 4. The organisation 5 coordinates response to disaster confirmed the above.

The Kenya Red Cross 6 the other hand has documented 7 fires in the Nairobi suburbs alone. 8, the body's regional disaster revealed to the media that the number could be 9 because fires that the immediate community manages to 10 are never reported, as are their damages.

This month alone, 11 houses in Watwa area and Kapiti plains have gone up in smoke. The 12 case has happened twice leaving in 13 wake two fatalities. Upendo neighbourhood is another on the list of the 14. Yet quite 15, people are quick to fault electrical systems. So, what is our level of fighting fires?

- |     |               |                |                 |                |
|-----|---------------|----------------|-----------------|----------------|
| 1.  | A. incidence  | B. incidents   | C. accidents    | D. incedent    |
| 2.  | A.in          | B. for         | C. about        | D. on          |
| 3.  | A. began      | B. begun       | C. had began    | D. has begun   |
| 4.  | A. goods      | B. properties  | C. property     | D. goodies     |
| 5.  | A. who        | B. whose       | C. that         | D. which       |
| 6.  | A. in         | B. by          | C. on           | D. as          |
| 7.  | A. twenty six | B. twenty -six | C. twenty sixth | D. twentysix   |
| 8.  | A. However    | B. Moreover    | C. Nevertheless | D. Furthermore |
| 9.  | A. more high  | B. higher      | C. more higher  | D. highest     |
| 10. | A. put up     | B. put on      | C. put off      | D. put out     |
| 11. | A. any        | B. enough      | C. some         | D. most        |
| 12. | A. latter     | B. later       | C. late         | D. latest      |
| 13. | A. it         | B. its'        | C. it's         | D. its         |
| 14. | A. infested   | B. affected    | C. effected     | D. infected    |
| 15. | A. rarely     | B. hardly      | C. seldom       | D. often       |



For questions 16 and 17, choose the correctly punctuated sentence

16. A. Mwatha asked me if I had bought lunch.  
B. Mwatha asked, have you bought lunch?.  
C. Mwatha asked me "If I had bought lunch?."  
D. Mwatha asked me whether bought lunch.
17. A. "Whose pen is this"? he asked.  
B. Its a cold day today.  
C. Peter and I are good friends.  
D. The dog ran into it's kennel.

For questions 18 and 19 choose the correct question tag to complete

18. Let's write neatly, \_\_\_\_\_?  
A. isn't it  
B. would we  
C. shall we  
D. is it
19. Everybody must be responsible, \_\_\_\_\_?  
A. must they  
B. must'nt they  
C. must not  
D. mustn't they

For questions 20 and 21, complete with a suitable ending.

20. Jayden doesn't like sweets \_\_\_\_\_.  
A. either do I  
B. neither do I  
C. and so am I  
D. neither don't I
21. Waihuini likes bananas, \_\_\_\_\_.  
A. do I so  
B. I so do  
C. so do I  
D. me two

For question 22 and 23, choose the word which means the same as the underlined word.

22. Our spelling drill team beat all the other teams.  
A. won  
B. overcome  
C. defeated  
D. humiliated
23. The meeting has been deferred due to unavoidable circumstances  
A. brought forward  
B. cancelled  
C. postponed  
D. held

For questions 24 and 25, choose the correct word to replace the underlined words.

24. My uncle deals in scarp metal.  
A. tackles  
B. smuggles  
C. herds  
D. buys and sells
25. Our vehicle broke down and stalled halfway into the journey.  
A. collapsed  
B. fainted  
C. lost consciousness  
D. failed

Read the passage and answer questions 26-38.

It is clear that most of our politicians are not pursuing the public interest and need to be checked. That is why Kenyans should keep close watch and ensure that the new constitution is implemented fully. They must say "NO" in word and deed, to anyone who is trying to sabotage the process. Most importantly, the commission must lead and ensure timely proper implementation of the new laws. It must use its authority boldly to ensure that the progress remains on track. It must safeguard the interest of Kenyans and rid the process of confusion and partisan grandstanding

The youth also have a key role to play here as an agent of change. They should come out as a civic voice. The new laws hold a bright future for young people. Therefore their involvement and that of other civil society groups is paramount. Young people must be at the forefront in opposing any attempt by the politicians to sabotage the implementation of the new constitution.

As young people we have the responsibility to push for the realization of the new laws and ensure the change that Kenyans voted for in the referendum is realised. Young people voted overwhelmingly for the new constitution. By doing so, they demonstrated that they were tired of the old order and wanted change. Most Kenyans believe that the new constitution will provide an opportunity for them to forge a better future together if properly implemented, the new constitution provides an opportunity to fight corruption, impunity, ethnicity and poverty which for years have impeded our growth and development.

It should not be lost on us that the process of implementing the new constitution is not the reserve of politicians and parliamentary committees. Kenyans must not relinquish their role and allow the politicians to control the process. Kenyan politicians have vested interest that threaten public good, therefore they cannot be trusted to be committed to the entrenchment of the culture of constitutionalism. A significant number of politicians are beneficiaries of the old order and are afraid that the new constitution dispensation will rob them of the privileges they enjoy.

They must not be given a free hand to cause confusion and derail the implementation of the new constitution. Indeed members of parliament need to realise that they are the people's agents and must therefore do a good job. Politicians have a responsibility to carry out the wishes of their bosses - the citizens. Kenyans want to enjoy the fruits of the new constitution they chose.

26. From the first sentence, it is clear that most politicians
- are selfish
  - are seeking the public interest
  - are keeping close watch to the public
  - are active in public
27. The words 'need to be checked' means
- the constitution needs to be checked
  - Kenyans need to be keen on actions of politicians
  - Kenyans need to be aware of the old constitution
  - the politicians should be aware of public actions
28. The word 'sabotage' as used in the passage mean?
- addressing the process
  - deliberately spoiling
  - implementing fully
  - watch carefully
29. Which one of the following is to lead in the implementation of the new laws?
- Politicians
  - The constitution
  - The commission
  - The public
30. Three of the following could interfere with the process of implementing the new laws except:
- partisan grandstanding
  - confusion of parliamentarians
  - safe guarding it by the public
  - sabotage by the leaders
31. Who are the beneficiaries of the full implementation of the new constitution as mentioned in the third paragraph?
- Civil society groups
  - Youth
  - Parliamentarians
  - Agents
32. Who among the following voted in large numbers for the new constitution according to the passage?
- Politicians
  - Public
  - The youth
  - Civil society
33. Three of the following can be trusted with the implementation of the new constitution except?
- Politicians
  - Civil Society
  - Youth
  - Public
34. Who among the following are referred to as the people's agents?
- Youth
  - Parliamentarians
  - Civil society
  - The government
35. The new constitution will help us fight three of the following EXCEPT
- inequality
  - sabotage
  - impunity
  - poverty
36. The words overwhelming as used in the passage means
- quickly
  - full implementation
  - in large numbers
  - sparingly
37. From the passage choosing the new constitution may be referred to as
- constitutionalism
  - constitutional dispensation
  - constitutional implementation
  - referendum
38. Which of the following would be the best title for the passage?
- The politicians
  - The Kenyan laws
  - The Constitution Implementation
  - The Constitution process

Read the following passage carefully and then answer questions 39 - 50.

A recent expose about a slum in Mombasa whose residents have been exposed to lead poisoning shocked the nation. According to the investigative piece, effluent from a metal refinery in the slums is likely to have affected thousands of people.

Lead is a highly toxic metal which if ingested or inhaled even in small amounts, can cause serious health problems to both children and adults. Children, especially those under six years, are more vulnerable because it leads to slow growth and learning difficulties.

Lead poisoning occurs when the metal builds up in the body, often over a period of months or years. Once in the system, lead is deposited in the bones and teeth. The main sources of lead poisoning are occupational, hobbies and environmental. Occupational exposure comes from construction, steel welding, bridge reconstruction workers, firing range instructors and cleaners, painters, scrap metal recyclers, auto repairers and cable handlers.

Hobbies such as casting bullets or target shooting at firing ranges, lead soldering, auto repair, stained glass making, glazed pottery making and ceramic ware. Lead exposure can occur through inhalation of fumes or dust that is laden with lead residue. Lead can also be ingested through contaminated hands, food, water, clothing and even cigarettes. There are some simple precautions that one can take to protect against lead exposure.

As employers, be responsible for the safety of your workers. As an individual or worker, know contractual arrangement and responsibilities towards your own health. Frequent testing is necessary for those whose occupation may expose them to lead.

Where lead poisoning has been diagnosed the immediate course of action is to discontinue exposure either through protective clothing or if it is a hazard then relocating from the source. Also don't forget that lead particles or dust can be brought into the home via work clothes and equipment. This is called "take home" lead and it can harm anyone who is exposed.

Avoid eating roadside food items as most of these foods are already exposed or contaminated with lead from the fumes from passing vehicles.

39. Where was the expose according to the first sentence? In a
- city
  - town
  - shanty
  - villages
40. What shocked the nation?
- poisoning
  - lead emission
  - unusual poisoning
  - a metal refinery
41. The cause of the problem might have been.
- effluent from a metal refinery
  - dirt in the slums
  - ingesting dirty food
  - hobbies like casting bullets
42. According to the passage when can lead be poisonous?
- when eaten in small amounts
  - when touched in small amounts
  - when used in small amounts
  - when sprayed in small amounts
43. How does lead affect children under six years?
- It leads to stunted growth and learning difficulties
  - It leads to learning difficulties only
  - It leads to weak bones
  - It leads to weak teeth
44. Which part of the body is the lead poison deposited?
- tongue
  - bones
  - skin
  - eyes
45. Which of the following is an environmental source of lead poisoning?
- Pottery making
  - Painters
  - Dust full of lead fumes
  - Auto-repair
46. The writer advises the following to employees except?
- frequent testing
  - be responsible for ones health
  - discontinue exposure
  - avoid vehicles
47. The phrase 'take home' as used in the passage implies that
- one can carry the poison back home via their clothes
  - some gifts employees carry home
  - contaminated foods that we carry home
  - the equipment we use at home is poisonous
48. "..... If it is a hazard then relocating is a solution means
- to move to a new place
  - to change clothes
  - to change eating habits by avoiding roadside foods
  - to be responsible
49. The synonym for the word 'via' as used in the passage is
- by
  - with
  - through
  - together
50. The best proverb to summarise the passage above would be
- Still waters run deep
  - Prevention is better than cure
  - Once bitten twice shy
  - A bird in hand is worth two in the bush

**Chagua jibu lifaalo zaidi kujazia mapengo 1-15**

Mila na 1 zilizopitwa na 2 zinafaa kutupiliwa 3 na kuzikwa 4 kaburi la 5, 6 wa mabinti ni dondo 7 katika jamii kadha zinazoishi katika maeneo 8 humu nchini. Kusema 9 ni jambo la kukera na kukereketa kuona mambo haya yakifanyika katika karne hii

A	B	C	D
1. tamasha	tambiko	kafara	tamaduni
2. njeo	nyakati	saa	wakaa
3. bali	ndidiya	umbali	mbali
4. kwa	kwenye	mwenye	katikati
5. ghafiri	fhafla	mava	mahafali
6. kukeketwa	kuketa	ukeketaji	ukete
7. ndogo	ndogu	sugu	kuu
8. kanie	kauka	kaukau	pane
9. yakini	mithili	mithaki	yumkini

10 wanapopelekwa 11 hukutana na kisu cha 12 ilihali nao magashi hupelekwa 13 ambako hushauriwa na masomo na 14 ambao huwafunza kuhusu 15 za nyumbani.

A	B	C	D
10. wavule	wavuli	wavyele	maghashi
11. uwanjani	pembeni	unyagoni	jandoni
12. gariba	ngariba	nyakanguzi	shahibu
13. nyakanga	unyagoni	kungwini	ufuoni
14. makungwi	wari	weledi	dalali
15. marubo	mawazo	ukungo	kunga



16. Jibu kwa maamkuzi sahihi  
Profesa Wangari Mathai alipewa mkono wa \_\_\_\_\_ kwa kushinda tuzo ya Mobil  
A. Jahani  
B. Tanzania  
C. Tahania  
D. Faraja
17. Bainisha matumizi ya 'ki'  
Kijoka kilikiuma kijiti cha kijumba cha kienyeji.  
A. udongo, kielelezi, ngeli  
B. ngeli, udongo, kielezi  
C. udongo, ngeli, kielezi  
D. ngeli, kielezi, udongo
18. Wanawake walioolewa na mume mmoja hivi tana mkemwenza ilhali sisi huwaita  
A. mhavile  
B. mitara  
C. watawa  
D. vinyere
19. Kikembe cha fisi ni kikuto nacho cha popo ni  
A. kipopo  
B. kidue  
C. kipura  
D. kipongea
20. Semi iliyopigiwa mstari ina maana gani?  
Maswali tuliyofanya yalikuwa mswaki  
A. yalikuwa mazito  
B. yalikosa majibu  
C. yalikuwa magumu  
D. yalikuwa rahisi
21. Chagua orogha yeneye vivumishi vya sifa ambishi  
A. Nadhifu, sita bora  
B. Jeme, hariri, kubwa  
C. imani, zuri, saba  
D. cheka, upendo, safi
22. Kanusha sentensi hii: Kusoma kwake kungefaa  
A. kusoma kwake kusingefaa  
B. kutosoma kwake kusingefaa  
C. kusoma kwake hakufai  
D. kutosoma kwake kusingefaa
23. Mahali maalum ambapo vyungu na matafali huchomewa huitwaje?  
A. meko  
B. choto

- C. joko  
D. jirafu

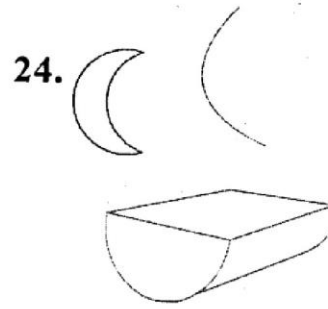

- Maumbo hayani  
A. haram, kistari, hori  
B. haram, tao, mche  
C. hilali, tao, kihori  
D. hilali, upinde, mche mraba

25. Vidole vya mguu huitwaje?  
A. viganja  
B. vitanga  
C. viano  
D. vitengele
26. Ukiona amabari na zinduna I papo Kivumbishi kilichopigiwa mstari ni kiambishi cha aina gani?  
A. kimilikishi  
B. kivumishi  
C. kihusishi  
D. kiwakilishi
27. Wanafunzi walisoma vitabu vichache maneno yaliyopigwa mstari ni?  
A. Nomino, kielezi  
B. Kitenzi kivumishi  
C. Kitenzi, sifa  
D. Kitenzi kivumishi idadi
28. Mtoto ambaye angali tumboni na bado hajazaliwa huitwaje? \_\_\_\_\_  
A. kimwana  
B. mwanaserere  
C. kiduchu  
D. kijusi
29. Chagua sentensi inayoonyesha 'ka' ya kusudi?  
A. Alienda msikitini na akasali  
B. Alisoma, akalaja kanywa na akalala  
C. walikaa, wakaenda zao wakashaulika  
D. Aliadhibiwa na wa wazazi akatoroka
30. Maradhi ya watoto ya kutokuwa na afya njema kutokana na kukosa lishe au chakula bora ni \_\_\_\_\_  
A. Surua  
B. Unyafuzi  
C. ukosadisha  
D. Waba



Mapinduzi yaliyotokea nchini Burundi ambapo jeshi lilitangaza kumpindua Rais Pierr Nkurunziza ni ya kushtua na hata kusikitisha. Lakini kutokana na nia ya kuendelea kukwambia madaraka, rais huyo aliyetaka kuchaguliwa kwa awamu ya tatu kinyume na katiba ya nchi yake, wanajeshi hawakuwa na budi ila kumwondoa. Bw Nkurunziza alijaribu kujitetea kwamba ingawa katiba ya Burundi inakataza mtu kuwania uraisi zaidi ya vipindi viwili, kipindi cha kwanza alifanya kuteuliwa tu.

Madai yake yaliwakera watu wengi wanaoheshimu demokrasia. Msimamo wa Bw Nkurunziza umeonekana kujitokeza hata humu nchini, ambapo viongozi wamekuwa wakisisitiza kutaka kukwambia maklakani, hata baada ya kuhusishwa katika maovu ya aina mbalimbali. Kwa mfano Raisi Uhuru Kenyatta alipowalilisha orodha ya watu wanaoshukiwa kuhusika na ufisadi, magavana walijitokeza na kutangaza kwamba hawako tayari kujiuzulu.

Walionelea heri wachunguzwe wakiwa mamlakani, huku wakidai kwamba katiba haitoi nafasi ya wao kuchukua hatua kama hiyo. Inavyofahamika ni kuwa mshukiwa yeyote wa ufisadi ambaye alichaguliwa na wananchi anapaswa kukaa kando na kuruhusu uchunguzi usioegemea upande wowote ufanywe. Kuendelea kukaa uongozini na kujipiga kifua kwamba mtu haendi popote kunatoa picha mbaya. Hata kuna wakati baadhi ya wanasiasa humu nchini walisikika wakisema ni heri wafe kuliko kujiuzulu.

Tunapojifunza kutokana na ukaidi wa Bw Nkurunziza, tunamwomba Rais Uhuru Kenyatta na viongozi wengine wa Afrika Mashariki wanaokutana nchini Tanzania, wamshauri ajivue mamlaka na kukubali uamuzi wa jeshi la nchi yake.

Burundi inafahamika kwa historia ya mwaka 1993 ambapo rais wake Melchior Ndadaye alikumbana na jaribio la kupinduliwa na alipokaidi hatua ya jeshi, akauawa.

31. Rais Nkurunziza alipinduliwa, hivi ni kusema kuwa?  
 A. alijiondoa uongozini  
 B. alingatuliwa kutoka mamlakani  
 C. alijingatua kutoka uongozini  
 D. alikaidi mapinduzi
32. Sababu za kupinduliwa kwa rais huyu ni? \_\_\_\_\_  
 A. ukosefu wa utawala bora  
 B. kutaka kuendelea kuongoza katika awamu ya pili  
 C. kukosa kusitisha uongozi uongozi wake baada ya awamu zake kuisha  
 D. kukosa kukithi haja za watu wake
33. Kiongozi huyu Nkurunziza anajitetea kwa madai kuwa?  
 A. hakupewa muda wa kutosha  
 B. muda wake haukuwa umeisha  
 C. alikuwa kiongozi wa kudumu  
 D. katika awamu ya kwanza aliteuliwa
34. Viongozi humu nchini wana mazoea gani?  
 A. ya kwamia uongozini  
 B. kukubali kushindwa  
 C. kutokwania uongozini  
 D. ya uongozi mzuri
35. Kulingana na habari hii Magarana walionelea ni heri?  
 A. wajiondoe katika kazi  
 B. wafungiliwe mashtaka  
 C. wachunguzwe wakiwa mamlakani  
 D. wasichunguzwe wala kushtakiwa
36. Semi kujipiga kifure ina maana ya? \_\_\_\_\_  
 A. kujipendelea zaidi  
 B. kujidai mbele za watu  
 C. kutishia maisha  
 D. kuwa na gere
37. Kisawe cha neneo ufisadi kinahusisha haya ytoe isipokuwa?  
 A. Chirimiri  
 B. Chauchau  
 C. Utapeli  
 D. Kuzuka mbuyu
38. Raisi Nkurunziza aliondolewa mamlakani na nani?  
 A. Wananchi wake  
 B. viongozi ambao walimchukia  
 C. wanajeshi wa nchi jirani  
 D. wanajeshi wa nchi aliyoongoza
39. Swala la viongozi pupinduliwa nchini Burundi  
 A. halijawahi kutokea kamwe  
 B. hutokea mara kwa mara  
 C. lime wahi kutokea tena hapo awali  
 D. huwa ni jambo la kawaida
40. Habari hii inaelezea kuhusu  
 A. Raisi wa Burundi  
 B. Historia ya inchi ya Burundi  
 C. Viongozi wa kiimla nchini Burundi  
 D. Mapinduzi ya serikali ya Burundi

**Soma habari hii kisha ujibu maswali 41-50**

Pamoja na hadhi na umaarufu wa kiswahili, bado lugha hii inakumbana na matatizo makubwa ya dhana na matumizi sahihi. Bado kuna baadhi ya watu wanaonasibisha Kiswahili na dini ya Kiislamu na hili limekuwa ni tatizo kubwa miongoni mwa watuiaji wake. Pia kuna upinzani mkubwa kutoka katika lugha ambazo zimekwisha kujitana katika dunia kama vile Kiingereza, Kifaransa, Kihispania, Kijerumani, Kichina, Kireno na Kiarabu. Watumiaji au watu wenye asili ya lugha hizo wanakipiga vita Kiswahili wakihofia kuwa wasipofanya hivyo kitazimeza lugha zao.

Kudharauliwa kwa lugha ya Kiswahili na kupigiwa chapuo kwa lugha za kigeni kwamba ndizo pekee zinazofaa kutumiwa katika shughuli mbalimbali za kiuchumi kwa kuwa zina hadhi ni changamoto kubwa. Kuna kasumba mbaya na mtazamo hasi kuhusu Kiswahili ambao unawafanya Wakenya kukitukuza na kushabikia zaidi Kiingereza ni sawa na lugha nyingine tu. Huku tukichunguza nafasi ya Kiswahili katika mfumo wa elimu nchini Kenya, ni vyema tukumbuke kuwa mfumo wa elimu wa nchi yoyote inayotegemea lugha ya kigeni hasa lugha ya waliokuwa watawala wao wa kikoloni huendeleza maadili ya kigeni na utegemezi.

Ingawa kwa sababu ya utandawazi, lugha huathiriana duniani kote, lugha za kigeni katika mfumo wa elimu hunuia kuendeleza mila na desturi za kigeni ambazo nyingi yazo haziambatani wala kulingana na matarajio na mahitaji ya kimaendeleo ya nchi kama ya Kenya. Kwa hivyo, ni muhimu kwa wataalamu, watafiti na wasomi wa lugha ya Kiswahili kujaribu kuipa nafasi inayostahiki lugha hii katika mfumo wetu wa elimu. Njia mojawapo ya kufanikisha malengo ya elimu katika nchi yoyote ile iwayo.

Kucheleweshwa kwa maamuzi ya sera ya kukipa hadhi Kiswahili kuwa lugha ya kufundishia na lugha funzwa inayotahiniwa katika nyanja zote za elimu ni pigo kubwa linalorudisha nyuma maendeleo ya Kiswahili. hali ya Wakenya kuwa nyuma katika kufanya tafiti mbalimbali kuhusu vipengele muhimu vya fasihi na isimu katika Kiswahili ili kuona ni jinsi gani tunaweza kufunguka kiakili na kufahamu umuhimu wa kuwa na lugha ya Kiswahili ni pingamizi nyingine. Uchumi mdogo wa nchi yetu

41. Kwa mujibu wa makala haya Kiswahili kinakumbwa na matatizo makubwa ya?  
 A. lugha nyingi pinzani  
 B. mawazo kuhusu matumizi sahili  
 C. waja wanaotumia lugha kivolaya  
 D. lugha za msimba
42. Watu wengi husababisha lugha ya Kiswahili na?  
 A. lugha ya kiarabu  
 B. lugha za kibantu  
 C. dini ya kiislamu  
 D. wafuasi wa dini ya kiislamu
43. Lugha duniani ambazo tayari zimekwisha jitamua ni zote hizi isipokuwa?  
 A. kifaranja  
 B. kihabeshi  
 C. kijerumani  
 D. kireno
44. Wanaokipinga Kiswahili ni wale ambao?  
 A. hawakielewi Kiswahili  
 B. wanao lazimika kuzungumza lugha hii  
 C. wasioelewa sheria na kanuni zake  
 D. wenye kiherehere kuwa lugha zao zitamezwa
45. Mtazamo hasi kuhusu Kiswahili ni?  
 A. ule wenye dhana aali  
 B. ule wenye dhana mbi  
 C. usio na dhana mbaya  
 D. husiano unaoleweka na wengi
46. Lugha ya kigeni katika mfumo wa elimu  
 A. husaidia wengine katika nchi ile  
 B. huboresha elimu kwa wakazi  
 C. huendeleza mila na desturi za ughaibuni  
 D. huleta maendeleo ya kielimu
47. Ni kina nani wanaoshauriwa na mwandishi kuhusika katika kukipa Kiswahili nafasi inayostahiki?  
 A. wenyeji, wageni na wakoloni  
 B. watafiti, wageni na wenyeji  
 C. watalamu, watafiti na wasomi  
 D. wasomi, wageni na wazalendo
48. Kiswahili hutumika katika shughuli hizi zote isipokuwa?  
 A. kuimba wimbo wa taifa  
 B. bungeni  
 C. mahakamani  
 D. katika somo la kingenge
49. Mwandishi analalamika kuwa wakenya hawafanyi nini kuhusiana na lugha?  
 A. hawafanyi utafiti  
 B. hawakizungumzi Kiswahili  
 C. huchanganya lugha ya Kiswahili na za Kigeni  
 D. hukibaronga Kiswahili
50. Makala haya yameeleza kuhusu  
 A. Lugha rasmi duniani  
 B. Lugha za Kigeni  
 C. Uwezekano wa kiswahili kutwezewa  
 D. Nafasi ya lugha ya Kiswahili nchini na ulimwenguni

Below is an ending of a story. Complete it in your own words and make it as interesting as possible.

..... I learnt that truly hardwork pays.





# KCPE FIFTH TRIAL

## STD 8 MARKING SCHEME 2015

ENGLISH		KISWAHILI		MATHS		SCIENCE		SOCIAL STUDIES			L.R.E
1. B	31. B	1. D	31. B	1. A	31. C	1. C	31. D	1. A	31. C	61. D	61. C
2. D	32. C	2. D	32. C	2. B	32. B	2. B	32. D	2. A	32. D	62. C	62. D
3. A	33. A	3. D	33. D	3. C	33. A	3. D	33. C	3. A	33. B	63. B	63. A
4. A	34. B	4. B	34. A	4. D	34. D	4. C	34. C	4. D	34. B	64. D	64. C
5. C	35. B	5. B	35. C	5. C	35. D	5. A	35. A	5. C	35. D	65. B	65. A
6. C	36. C	6. A	36. B	6. D	36. B	6. B	36. C	6. A	36. C	66. D	66. C
7. B	37. D	7. C	37. C	7. A	37. C	7. A	37. D	7. C	37. B	67. D	67. B
8. A	38. C	8. A	38. C	8. B	38. D	8. D	38. D	8. C	38. C	68. C	68. B
9. B	39. C	9. A	39. C	9. D	39. C	9. C	39. C	9. B	39. B	69. A	69. A
10. D	40. C	10. B	40. D	10. A	40. A	10. C	40. C	10. D	40. C	70. B	70. A
11. C	41. A	11. D	41. B	11. B	41. C	11. B	41. B	11. C	41. B	71. D	71. A
12. A	42. A	12. B	42. C	12. C	42. B	12. D	42. C	12. A	42. A	72. D	72. A
13. D	43. A	13. B	43. B	13. D	43. A	13. A	43. C	13. B	43. D	73. B	73. C
14. B	44. B	14. A	44. A	14. B	44. D	14. B	44. A	14. B	44. C	74. C	74. A
15. D	45. C	15. D	45. B	15. C	45. D	15. C	45. C	15. D	45. D	75. D	75. B
16. A	46. D	16. C	46. C	16. D	46. C	16. D	46. B	16. D	46. A	76. B	76. A
17. C	47. A	17. C	47. C	17. A	47. B	17. C	47. A	17. C	47. C	77. B	77. B
18. C	48. A	18. A	48. D	18. B	48. A	18. B	48. A	18. D	48. C	78. C	78. D
19. D	49. C	19. D	49. A	19. D	49. A	19. D	49. D	19. B	49. B	79. B	79. D
20. B	50. B	20. D	50. D	20. A	50. D	20. B	50. B	20. D	50. D	80. A	80. C
21. C		21. A		21. A		21. B		21. C	51. C	81. D	81. A
22. C		22. D		22. C		22. B		22. C	52. B	82. C	82. B
23. C		23. C		23. C		23. A		23. B	53. D	83. D	83. C
24. D		24. C		24. B		24. D		24. D	54. A	84. C	84. C
25. D		25. C		25. D		25. C		25. C	55. D	85. D	85. C
26. A		26. C		26. A		26. A		26. B	56. C	86. B	86. A
27. B		27. D		27. B		27. A		27. C	57. B	87. A	87. A
28. B		28. D		28. B		28. D		28. D	58. B	88. D	88. B
29. C		29. A		29. D		29. A		29. B	59. C	89. C	89. C
30. C		30. B		30. A		30. D		30. B	60. A	90. C	90. B

### A COMPOSITION MARKING SCHEME

#### MARKING CRITERION

1. The composition will be assessed according to the following guidelines.

- The maximum mark will be 40 and the minimum mark 01

- Does the script show that the candidate can communicate accurately, fluently and imaginatively in English?

#### Accuracy (8 marks)

a) Correct tenses and agreement of verbs (4 marks)

b) Accurate use of vocabulary (4 marks)

(16) c) Following a sequence (4 marks)

d) Correct punctuation (4 marks)

#### Fluency (8 marks)

a) Words in the correct order (4 marks)

b) Sentence connection and paragraphs (4 marks)

c) Correct spelling (4 marks)

d) Ideas developed in logical sequence (4 marks)

#### Imagination (8 marks)

a) Unusual but appropriate use of words and phrases (4 marks)

b) Variety of structure (4 marks)

**NB: Please, teachers are requested to scrutinize this marking scheme before use, it is worth**