



KCPE TRIAL EXAMINATION

STANDARD 8 – 2015

SCIENCE

Time: 1 Hour 40 minutes

READ THESE INSTRUCTIONS CAREFULLY

1. You have been given the question booklet and a separate answer sheet. The question booklet contains 50 questions.
2. Do any necessary rough work in this booklet.
3. When you have chosen your answer, mark it on the **ANSWER SHEET**, not in the question booklet.

HOW TO USE THE ANSWER SHEET

4. Use an ordinary pencil only.
5. Make sure that you have written on the answer sheet.

YOUR INDEX NUMBER

YOUR NAME

NAME OF YOUR SCHOOL

6. By drawing a **dark line** inside the correct numbered boxes mark your full Index Number (i.e. School Code Number and the three-figure Candidate's Number) in the grid near the top of the answer sheet.
7. Do not make any marks outside the boxes.
8. Keep your answer sheet as clean as possible and do not fold it.
9. For each of the Question 1 – 50 four answers are given. The answers are lettered A, B, C and D. In each case only **ONE** of the four answers is correct. Choose the correct answer.
10. On the answer sheet the correct answer is to be shown by drawing a **dark line** inside the box in which the letter you have chosen is written.

EXAMPLE

In the Question Booklet:

4. The carnassials teeth are mainly used for _____.
- A. tearing flesh B. grinding flesh
C. cutting flesh D. slicing flesh

The correct answer is D

On the answer sheet:

4 [A] [B] [C] [D] 14 [A] [B] [C] [D] 24 [A] [B] [C] [D] 34 [A] [B] [C] [D] 44 [A] [B] [C] [D]

In the set of boxes numbered 4, the box with the letter **D** printed in it is marked.

11. Your dark line **MUST** be within the box.
12. For each question **ONLY ONE** box is to be marked in each set of four boxes.

Branded Eagle is a mark of genuine High Flyer Series Exams and Books. Beware of imitations.



© High Flyer Series, 2015

Tel. 0723 499860

TURN OVER

- A. Stall feeding
- B. Herding
- C. Paddockging
- D. Strip grazing

10. Which one of the following explains the functions of carnassials teeth in a dog?

- A. Catching the prey
- B. Slicing bones and flesh
- C. Killing the prey
- D. Crushing flesh and bones

11. Which one is not a sign of unhealthy crops?

- A. Distortions
- B. Stunted growth
- C. Shallow roots
- D. Streaks on the leaves

12. Which diagram below shows the phase of the moon that comes between the sun and the earth?

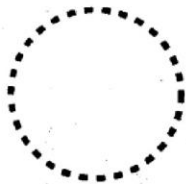

A



B

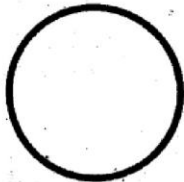

C



D

13. Kamau, a standard 5 pupil saw wind swaying trees in the eastern direction. In which direction did the arrow of a wind vane point?

- A. East
- B. North
- C. South
- D. West

14. The most convenient method of storing water for irrigation is by use of

- A. Tanks
- B. Jerricans
- C. Dams
- D. Drums

15. The planet that takes the shortest time to go round the sun is known as?

- A. Morning star
- B. Red planet
- C. Evening star
- D. Uranus

16. The diagram below shows an activity performed by standard 4 pupils during their science lesson

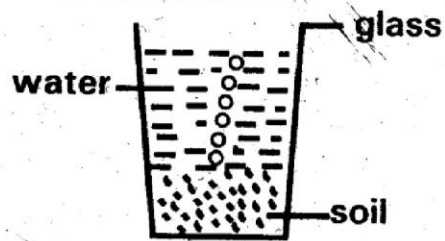

From the activity, the pupils concluded that there is.....in soil?

- A. Humus
- B. Air
- C. Water
- D. Animals

17. The following are human activities that increase the rate of soil erosion. Which one is NOT?

- A. Overgrazing
- B. Steep slope
- C. Deforestation
- D. Overstocking

18. Which one of the following is not an advantage of calcium ammonium nitrate?

- A. It is easily leached
- B. It is easy to transport
- C. It is easily absorbed by plant roots
- D. It promotes high crop yields

19. The smoothness in clay soil is caused by _____

- A. A lot of water
- B. Rough texture
- C. Small particles
- D. Poor drainage

20. Which of the following material is not needed in a experiment that shows light travels in a straight direction?

- A. Cardboard
- B. Mirror
- C. Candle
- D. Nail

21. When warming yourself using a charcoal jiko heat reaches your feet by _____

- A. Convection
- B. Conduction
- C. Absorption
- D. Radiation

22. John, a standard 5 pupil called his friend who was 100m away using a folded paper. Which type of sound was John producing?
- A. Loud sound B. High sound
C. Soft sound D. Low sound

23. The following are arrangements of bulbs, wire and dry cells made by standard 7 pupils during their science lesson.

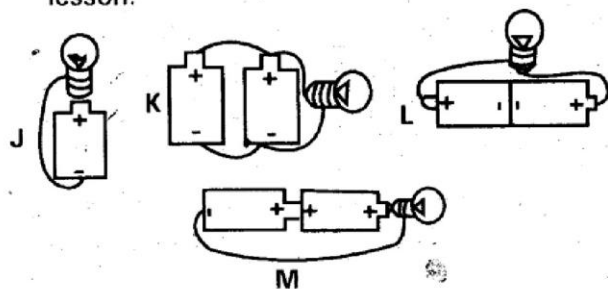

Which pair of arrangement did the bulb light with same brightness?

- A. J and K B. K and M
C. L and M D. J and L
24. Which one of the following shows the energy changes that occur in an electromagnet?
- A. Chemical-electrical-heat-light
B. Chemical-electromagnet-electrical-sound
C. Chemical-electrical-magnetism
D. Chemical-electrical-light-heat
25. The following are ways of using energy sparingly. Which one is not?
- A. Sharing transport when travelling in the same direction
B. Using energy from the sun to dry cereals
C. Switching off light when not in use
D. Maintaining roads in the country
26. In which of the following substances are particles closely packed?
- A. Flour and charcoal
B. Water vapour and smoke
C. Oil and wax
D. Spirit and water
27. Wambui heated ice and then measured its temperature. If the temperature measured was 30°C , what was the temperature increase of the ice?
- A. -30°C B. 100°C
C. 0°C D. 30°C

28. Which two liquids when mixed can be separated by decantation?
- A. Milk and water
B. Kerosene and cooking oil
C. Water and spirit
D. Oil and water

29. The diagram below shows the various components of air

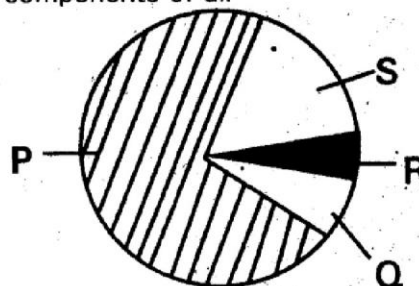

Which letter represents the component of air that is used in making plant proteins?

- A. P B. Q
C. K D. S
30. Which one of the following shows materials that a magnet can attract?
- A. Pins, copper coin, pin and steel spoon
B. Needle, nail, pin and steel spoon
C. Aluminium plate, rubber band, oil and plastic
D. Cardboard, steel door, needle and zinc plate
31. The following are ways of maintaining simple tools. Which one is not?
- A. Sharpening cutting tools
B. Cleaning after use
C. Keeping them in damp places
D. Replacing broken handles
32. Gravitational force on an object is known as?
- A. Friction B. Weight
C. Mass D. Inertia
33. Which one of the following shows a pair of levers that have a longer load distance than the effort distance?
- A. Crowbar and seesaw
B. Claw hammer and lid opener
C. Wheel barrow and bottle opener
D. Spade and fishing rod

34. Which machine below makes work easier by changing direction of effort?
- Ladder
 - Winch
 - Flag post
 - Wheel barrow
35. Which list below shows examples of foods that belong to the same food group?
- Maize, carrots, rice and soya
 - Irish potato, spinach, green grams and chapatti
 - Carrots, spinach, kales and pineapple
 - Fish, beans, ugali and kales
36. A child suffering from anaemia will show the following signs and symptoms except?
- Pale skin
 - Wrinkled face
 - General body weakness
 - White fingernails and gums
37. Which one of the following is not an effect of air pollution?
- Global warming
 - Allergies to human beings
 - Respiratory diseases
 - Loss of fertility in the soil
38. When hot hard water is passed through pipes, it produces?
- | | |
|---------|----------|
| A. Fur | B. Scale |
| C. Scum | D. Foam |
39. Which activity below will control both external and internal livestock parasites when practiced by a farmer?
- Drenching
 - Rotational grazing
 - Spraying
 - Dosing
40. The following are animal products;
- Mohair
 - Hides
 - Eggs
 - Mutton
 - Milk
 - Skin
 - Beef
 - Wool

Which of the above products are obtained from goat only?

- (i), (iv), (vi), (viii)
 - (ii), (iii), (vi), (vii)
 - (i), (iv), (v), (vi)
 - (iv), (v), (vi), (viii)
41. Which of the following plants does not experience self pollination?
- Pawpaw
 - Maize
 - Beans
 - Mango
42. Among the following practices, which one will not help in preventing a disease that causes prolonged coughing?
- Avoid dusty places
 - Drinking boiled milk from cows
 - Sleeping under treated nets
 - Getting BCG Vaccine
43. Which one of the following is a pair of green flowerless plants?
- Algae and mould
 - Mucor and puffballs
 - Fern and liverworts
 - Yeast and mushroom
44. The following are ways of showing care to people infected with HIV and AIDS. Which one is not?
- Providing medical support
 - Showing sympathy
 - Showing love
 - Providing them with food
45. Which one of the following is not true about hydrophytes?
- They have thin waxy cuticle
 - They have long flexible stems
 - They have wide leaves
 - They have reduced number of stomata
46. In the male reproductive system, which part carries sperms from the testis?
- Sperm duct
 - Urethra
 - Penis
 - Scrotum

47. The diagram below shows the human kidney;

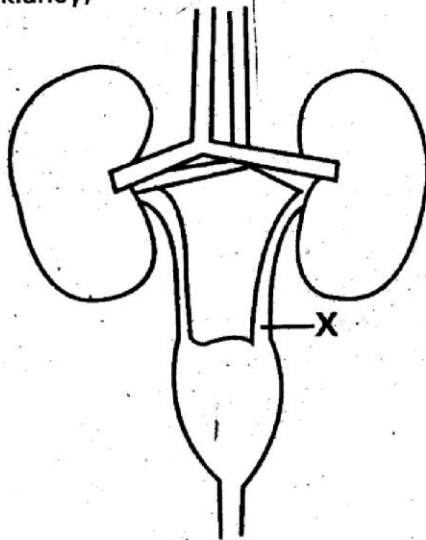

The part marked X is called?

- A. Urethra
- B. Bladder
- C. Ureter
- D. Kidney

48. Which one of the following is not common in both boys and girls during adolescence?

- A. Pimples appear on their face
- B. Voice breaks
- C. Produce sex cells
- D. Grow pubic hair

49. The following are causes of water pollution. Which one is not?

- A. Treated industrial effluent
- B. Farm chemicals
- C. Oil spillage
- D. Flood

50. Which material below is not needed when investigating water retention in different samples of soils?

- A. Water
- B. Cotton wool
- C. Tubes
- D. Funnels

Read the passage below carefully. It contains blank spaces numbered 1 – 15. For each blank space, choose the BEST alternative from the choices given.

The _____ 1 _____ space surrounding the earth is called the atmosphere. It is part of the environment we _____ 2 _____ to as air. It is _____ 3 _____ up of gases such as nitrogen, oxygen and carbon dioxide. There _____ 4 _____ also water vapour, soot and dust.

The atmosphere _____ 5 _____ us in many ways. Living things _____ 6 _____ air in order to survive. The gases in the atmosphere help to _____ 7 _____ the heat from the sun around the earth to keep the _____ 8 _____ warm.

The atmosphere also _____ 9 _____ us from being bombarded with meteorites. Meteorites are _____ 10 _____ lumps of rock that fall on the _____ 11 _____ surface from outer space. If you _____ 12 _____ to fly up to 25 kilometer _____ 13 _____ the earth's surface you _____ 14 _____ come to the upper layer of the atmosphere. This part of the atmosphere _____ 15 _____ the ozone layer.

- | A | B | C | D |
|-------------|----------|----------|----------|
| 1. vast | long | tall | fast |
| 2. call | know | refer | name |
| 3. goes | made | produces | brought |
| 4. was | are | were | is |
| 5. needs | helps | provide | produce |
| 6. need | takes | give | produce |
| 7. trap | grat | drag | crop |
| 8. whole | hole | surprise | surface |
| 9. exposes | disposes | protects | promotes |
| 10. good | terrible | huge | super |
| 11. earth's | earths | earth's | earth |
| 12. was | must | can | were |
| 13. about | below | under | above |
| 14. would | could | should | must |
| 15. brings | holds | seizes | calls |

For questions 16 – 18, choose the word that is similar in meaning to the underlined words.

16. All of a sudden, we heard gun shots.
 A. immediately
 B. unexpectedly
 C. soon
 D. quickly
17. Munga shivered at the thought of sleeping alone.
 A. feared
 B. shuddered
 C. resisted
 D. resented
18. Paty implies that you are rascals.
 A. say
 B. proves
 C. suggest
 D. think

In questions 19 – 20, choose the correctly punctuated sentences.

19. A. "Go to the market" He said. "And buy some fruits."
 B. "Go to the market, he said, and buy some fruits."
 C. "Go to the market and buy some fruits," he said.
 D. "Go to the market." He said " and buy some fruits"
20. A. She looked at me and shouted, "Get away from me!"
 B. "She looked at me and shouted, get away from me!"
 C. She looked at me and shouted!"Get away from me!"
 D. She looked at me and shouted "get away from me!"

For questions 21 – 23, choose the word that is opposite to the underlined word.

21. There was a rumour that price of oil was going to drop.
 A. lie B. saying
 C. new D. report
22. It is possible that we will meet tomorrow.
 A. unable B. likely
 C. unlike D. uncertain
23. The hunter approached the lion cautiously.
 A. dangerously B. noisily
 C. happily D. carelessly

For questions 24 – 25 complete the sentence correctly.

24. The war lasted _____.
 A. For several year
 B. Since 1902
 C. Since 1902 to 1907
 D. Fifty years
25. He failed his test _____ he found it very difficult.
 A. therefore B. so that
 C. thus D. as

Read the passage below and then answer questions 26 – 39.

In Asia most deer are small. The axis deer of India are about the largest. The bucks grow to only three feet tall. They have large and very beautiful antlers. The axis deer look very much like red deer of Europe. Next in size comes the roe deer. They live all over Asia, north of the Himalayas, as well as in Europe. Roe deer are very unusual because they live in pairs instead of in herds. They stay with the same partner for life, which means the buck has no fighting to do in the mating season. Instead, the buck and the hind seem to enjoy chasing each other round and round in circles for hours on end. If you see several pairs all doing this at the same time it make you quite dizzy!

The commonest deer in South – East Asia are the muntjaks or barking deer. They are tiny creatures, no more than 22 inches high and also two unusually long teeth which grow out in the form of tusks. The antlers are for fighting and the tusks are used for digging roots and bulbs out of the ground. The females have little bumps on their foreheads, like two small furry horn. Another odd thing about these deer is that they have long, thin tails. China has several kinds of deer which are not seen anywhere else in the world. The Chinese water deer are the smallest of these. They are 20 inches tall. As their name suggests, these deer like to live near swamps and rivers, where there are plenty of juicy water plants. The bucks have to fight with their tusks because they have no antlers.

Lastly, we come to the musk deer. Again the bucks are only about 20 inches high, and in Korea they are even smaller. Musk deer could never be mistaken for any other kind of deer because of their smell. In a gland under his abdomen every buck carries a sweet smelling substance called musk. No other animal will eat a musk deer because his flesh tastes musky too. But the deer are hunted nonetheless. Musk is valuable because it is used a great deal all over Asia for making perfume. Musk deer are found in forests all over central and North-East Africa. If ever you have a chance to see any of these tiny Asian deer in museum, or a zoo, you will be amazed at how fragile and unprotected they look. They must have many enemies. The musk deer has his smell to protect him. But the other Asian deer have to rely on all their keen senses as well as their great speed in order to survive.

26. The largest Asian deer are found in _____.
 A. India B. Burma
 C. Malaya D. China

27. The largest Asian deer are called _____.
 A. axis deer B. barking deer
 C. musk deer D. roe deer

28. According to the passage axis deer are similar to _____.
- A. the elk B. red deer
C. roe deer D. water deer
29. According to the passage it is TRUE to say?
- A. China has all kinds of deer found in the world
B. Barking deer have long thin tails.
C. Musk deer can be mistaken to other deer.
D. Roe deer are the same as Axis deer
30. Roe deer are unusual because _____.
- A. they live in pairs and not in herds.
B. their bucks are very small.
C. they chase each other in circles as they feed.
D. they are smaller than European deer.
31. The deer that use their tusks for protection is the _____.
- A. barking deer
B. chinese deer
C. chinese water deer
D. musk deer
32. Animals do not eat musk deer because _____.
- A. Their meat are tough
B. They are hostile
C. Their meat has musk
D. They fight to death.
33. Roe deer has small antlers because _____.
- A. Small deer have small antlers.
B. They get broken so often in fighting.
C. Antlers do grow well in cold places.
D. They do not need them for fighting.
34. One of the deer is found in only one country. It is the _____.
- A. roe deer B. muntjaks
C. water deer D. musk deer
35. The most numerous deer in South East Asia are _____ deer.
- A. axis B. musk
C. roe D. barking
36. If you want to see most deer visit _____.
- A. India B. Europe
C. China D. Korea
37. It is FALSE to state that _____.
- A. Most kinds of deer are found in China
B. All kinds of deer are found in China
C. There are deer in Europe
D. Roe deer are peculiar
38. Deer in Asia depend on all their keen senses and great speed for protection except _____.
- A. axis deer B. roe deer
C. barking deer D. musk deer
39. According to the passage deer use tusks for _____.
- A. Digging and fighting
B. Digging out food
C. Fighting enemies
D. Produce perfumes

Read the passage below and then answer questions 40 – 50.

Leather is a tough material and many people do not know where it is got from. It is tough, yet smooth and hard-wearing material which has so many different uses. It is the pride of shoemakers! Leather is simply got from animals. It is the skin from animals with hair fur or wool removed. Nowadays, the skin of many different animals such as the cow, horses, sheep, goat, pig, deer and many more. The skins of the larger animals are called hide and those of the smaller animals are called skin.

Hide and skin have to be prepared through a process. At first, the skin is carefully removed so that it comes off in one whole piece from the animals. The fleshy side of the skin is rubbed with salt to prevent decay. It is then sent to a leather factory or tannery. At the tannery, the skin is cut to remove all unwanted parts and thrown into large tanks full of salted water called brine. Here, the skins are left for two or three days to be cleaned and softened. When they are

taken out they are put into a machine which cuts away all remaining bits of flesh. The skins are next placed in a tank contain lime, which loosens the hair, fur or wool. From there they are placed in a machine, which easily scrapes off the hair, fur or wool and splits the skin into two sheets. The hair side is called- grain leather and the flesh side is the suede leather. The skins are now ready for tanning. Tanning is the process of turning the skin of animals into leather by using chemicals.

The purpose of tanning is to make the skin soft, yet tough and water proof. This is done by hanging them in tanks of water containing brown dye, usually oak bark. The skins pass through several of these tanks each one with stronger moisture than the one before. To make soft leather such as kid, chamois and buckskin, the tanning is done in oil and the surface rubbed with a powder called emery. The skins are then dried, oiled and ironed using large heavy rollers. At last we have fine sheets of leather which are sent to factories to be made into different kinds of items. These include bots, shoes, jackets, chair covers, purses, pouches, school bags, cases, handbags, luggage cases, gloves, horse harnesses, football, bicycle saddles, dog collars and belts.

40. Leather is the pride of shoemakers because _____.
- A. Leather has many uses
 - B. There is nothing like leather
 - C. Leather is the toughest material
 - D. Leather is hard wearing stuff
41. Leather is _____.
- A. Skin with hair, fur or wool removed
 - B. Skin which is not slaughtered
 - C. Dark soft skin
 - D. Tough material
42. Skin should be removed carefully from the animal to _____.
- A. Produce strong leather
 - B. Have one whole piece
 - C. Prevent decay
 - D. Get a good hide
43. After rubbing salt to the fleshy side of the skin, it _____.
- A. Is soaked for some time
 - B. It taken to the tannery
 - C. Makes leather items
 - D. Is left out to dry
44. According to the passage, the skin is left for two to three days in brine to _____.
- A. Make it salty
 - B. Remove fur, hair or wool
 - C. Soften and clean it
 - D. Remove unwanted parts.
45. From the passage lime is used for _____.
- A. Scrapping hair, fur or wool
 - B. Making leather tough
 - C. Cutting away unwanted parts
 - D. Loosening, fur, hair or wool
46. It is true to state that _____.
- A. By the time skin is split into two, tanning has already happened
 - B. There is no use of using machines to remove fur, hair or wool
 - C. The hair side is called suede leather
 - D. Skin is only ready for tanning when fur, hair or wool is scrapped.
47. All the following are reasons for tanning apart from _____.
- A. making skin waterproof.
 - B. removing any hair, fur or wool.
 - C. making skin tough.
 - D. making skin soft
48. The softest leather can be obtained by _____.
- A. putting in tank of water.
 - B. passing in oak bark once.
 - C. passing in strong dye.
 - D. using oil and rub using emery.
49. From a horse we get _____.
- A. Skin and hide
 - B. Skin only
 - C. Hide
 - D. Brine and emery
50. The BEST title for the passage is?
- A. Skins and hide
 - B. The work of a tannery
 - C. The process of making leather
 - D. Use of lime



JARIBIO LA MTHANI WA KCPE

DARASA LA NANE – 2015

LUGHA YA KISWAHILI

Muda: Saa 1 dakika 40

SOMA KWA MAKINI MAAGIZO YAFUATAYO

1. Umepewa kijitabu hiki cha maswali na karatasi ya kujibu. Kijitabu hiki kina maswali 50.
2. Ikiwa utataka kuandika chochote ambacho si jibu andika katika kijitabu hiki.
3. Ukisha chagua jibu lako lionyeshe katika **KARATASI YA MAJIBU** na wala sio katika kijitabu hiki cha maswali.

JINSI YA KUTUMIA KARATASI YA MAJIBU

4. Tumia penseli ya kawaida.
5. Hakikisha ya kwamba yafuatayo yameandikwa katika karatasi ya majibu.

NAMBA YAKO YA MTHANI

JINA LAKO

JINA LA SHULE YAKO

6. Kwa kuchora kistari katika visanduku vyenye namba zinazokuhusu, onyesha namba yako kamili ya mthani (yaani namba ya shule na zile namba tatu za mtahiniwa) katika sehemu iliyotengwa mwanzo wa karatasi ya majibu.
7. Usitie alama zozote nje ya visanduku.
8. Iweke safi karatasi yako ya majibu.
9. Kwa kila swali 1 – 50 umepewa majibu manne. Majibu hayo yameonyeshwa kwa herufi A, B, C, D. Ni jibu **MOJA** tu kati ya hayo manne ambayo ni sahihi. Chagua jibu hilo.
10. Kwenye karatasi ya majibu, jibu sahihi lionyeshe kwa kuchora kistari katika kisanduku chenye herufi uliyochagua kuwa ndilo jibu.

MFANO

Katika kijitabu cha maswali:

21. Tumia kiwakilishi 'amba' kujaza mwanya.

Mtoni _____ anateka maji ni kuchafu.

- A. ambapo B. ambamo
C. ambao D. ambako

Jibu sahihi ni D

Katika karatasi ya majibu

1 [A] [B] [C] [D] **11** [A] [B] [C] [D] **21** [A] [B] [C] [D] **31** [A] [B] [C] [D] **41** [A] [B] [C] [D]

Katika visanduku vinavyoonyesha majibu ya swali namba 21, kisanduku chenye herufi **B** ndicho kilichochoywa kistari.

11. Chora kistari chako vizuri. Kistari chako kiwe cheusi na kisijitokeze nje ya kisanduku.
12. Kwa kila swali, chora kistari katika kisanduku kimoja tu kati ya visanduku vine ulivyopewa.

Branded Eagle is a mark of genuine High Flyer Series Exams and Books. Beware of imitations.

© High Flyer Series, 2015

Tel. 0723 499860

Fungua Kurasa

Chagua jibu sahihi na ujaze nafasi 1-15

Mhanga ni aina ya _____ 1 _____ mkubwa kama mbwamwitu. Ana pua ndefu _____ 2 _____ mbwa _____ 3 _____ yule. Huaminika kwamba chakula _____ 4 _____ kikuu ni wadudu waitwao mchwa. Mhanga ana hulka _____ 5 _____ ajabu sana. Tena mwenye kipawa cha _____ 6 _____ kabisa. Anaishi _____ 7 _____. Kuna msemu maarufu unaosema, _____ 8 _____. Msemu unamaanisha kujitolea kabisa.

- | A | B | C | D |
|-----------------|------------------|----------------|-------------|
| 1. ndege | mnyama | wanyama | nyuni |
| 2. kumliko | kushida | kuwaliko | kuliko |
| 3. yoyote | yeyote | lolote | wowote |
| 4. yake | chake | lake | vyao |
| 5. ya | za | na | wa |
| 6. kipekee | pekee | namna | vile |
| 7. shimo | ndani ya shimoni | katika shimoni | shimoni |
| 8. kumpa mhanga | kujitoa mhanga | kujipa mhanga | kula mhanga |

Nyuni au ndege ni aina _____ 9 _____ ya ndege wanaopuruka na _____ 10 _____. Kuku ndiye ndege aliye karibu zaidi na _____ 11 _____ binadamu. Nyuni ana _____ 12 _____ ambacho ni kidomo cha kudonea punde na wadudu, _____ 13 _____ kilemba cha jogoo, _____ 14 _____ ni sehemu inayotumiwa na ndege kwa kukanyagia, _____ 15 _____ ni kiungo kilicho tumboni kinachosaga chakula kilicholiwa na ndege.

- | A | B | C | D |
|-----------------|-------------|--------------|----------|
| 9. yoyote | yeyote | wowote | zozote |
| 10. asiyeburuka | wasiopuruka | wasiyepuruka | asiyepaa |
| 11. hao | sisi | yeye | wao |
| 12. kacha | kidona | fingisi | undu |
| 13. undu | kacha | fidia | kidona |
| 14. kacha | kwato | undu | kidona |
| 15. wengu | kacha | firingisi | figo |

Kutoka swali la 16-30 jibu kulingana na maagizo

16. Kanusha sentensi ifuatayo
Mkate uliopikwa umeuzwa
A. Mkate usiopikwa haujauzwa
B. Mkate uliopikwa haujauzwa
C. Mkate usiopikwa umeuzwa
D. Mikate isiopikwa haijauzwa

17. Chagua sentensi sahihi
A. Mitume mingi imefika
B. Mitume nyingi imefika
C. Mitume wengi wamefika
D. Mitume wingi imefika

18. Neno ndovu lina maana sawa na
A. Tembo
B. Mbogo
C. Gwase
D. Bakari

19. Tambulisha jina la makundi lisilofaa
A. umati wa watu
B. bumba la nyuki
C. kikosi cha watu
D. chane ya ndizi

20. Kamilisha tashbihi
Chafu kama _____
A. Fugo
B. Ngiri
C. Jongoo
D. Giza

21. Chagua sentensi inayoonesha wingi wa:
Unga wangu umeisha
A. Nyunga zetu zimeisha
B. Unga wetu umeisha
C. Unga zao zimeisha
D. Nyunga zao zimeisha

22. Sarakasi ni:-

- A. Mchezo wa kurukaruka
- B. Mchezo wa kushikana na kuangushana
- C. Michezo ya kistadi ya kuonyesha vitendo visivyo vya kawaida
- D. Mchezo wa mpira wa nyavu

23. Mnadi ni mtu anayetangaza jambo fulani, Mnadi pia ni:

- A. Uuzaji wa vitu kushidana
- B. Mtu anayetangaza bei na kuuza mnadani
- C. Mtu mkorofi
- D. Aina ya ndege aliye stadi wa kusuka viota

24. Chagua jibu lifaalo kuelezea maana ya methali:

- Hakuna bahari isiyo mawimbi
- A. Shida au misukasuko ni sehemu mojawapo ya maisha
 - B. Fikiria mambo, kabla ya kuyafanya
 - C. Kila jambo lina mipaka yake
 - D. Dalili fulani zinazowashiria kutokea kwa jambo

25. Akisami hii 4/5 huitwa _____

- A. Khumusi tano
- B. Khumusi nne
- C. robo tano
- D. Thuluthi nne

26. Vitu kumi na viwili kwa pamoja huitwa _____

- A. Korija
- B. Bunda
- C. Darzeni
- D. Jozi

27. Mtoto wa bata anaitwa _____

- A. Kifaranga
- B. Kiyoyo
- C. kimatu
- D. Kinda

28. Juma alipiga maji akalewa _____

- A. Chumbwi
- B. Chopi
- C. Chakali
- D. Chururu

29. Kutokana na jina mlio tunapata kitenzi _____

- A. Mlia
- B. kilio
- C. mlizi
- D. lia

30. Chagua orodha ya vihusishi pekee:

- A. Baada ya, badala ya, kando ya, mbali na
- B. chini ya, karibu na, katikati ya, miongoni mwa
- C. karibu na, kabla ya, mbele ya, labda
- D. kefulu! Salaale! Ewaa! Lo!

Soma ufahamu huu kwa makini kisha ujibu swali la 31-50

Waswahili walisema, "kusafiri kwingi kuona mengi," Nami nimeuthibitisha msembo huu katika miaka michache hii iliyopita; kwani nimesafiri siku za heri na siku za shari, vuli na masika, matlai na kusi, angani na majini. Katika safari zote hizi, kusafiri kwa ndege ulaya kulinikera sana.

Kabla ya safari kuanza, kila mmoja wetu aliyumbayumba kwa hamu ya kujiona yuko angani kama mbayuwayu. Wakati wa kuingia katika ndege, kila mmoja wetu alisita kidogo; kwani muda kidogo uliokuwa umepita tulipashwa habari kwamba ndege moja ilikuwa imeanguka katika nchi jirani na ikawaua abiria wote waliokuwa ndani yake. Basi kila mmoja wetu alijikakamua na kujitia moyo, akijifanya kwamba haogopi; lakini kwa kweli damu yangu ilikuwa imebadilika kuwa maji. Tulijipa moyo kwa kusema kimoyomoyo kwamba hiyo ilikuwa ni ajali tu; na hakuna uwezekano wa ajali mbaya, kama hiyo kutokea tena hivi karibuni. Lakini je, kuna sheria yoyote iliyoandikwa na Maulana au mwanadamu inayosema kwamba ajali haziwezi kufuatana?

Basi wakati mawazo kama hayo yalipokuwa yakipitapita ubongoni mwangu, nilitahamaki nimekaa katika kiti changu ndani ya ndege. Niliweka mikono mbele yangu nikaifumbata ili niseme sala kimoyomoyo. Nikaweka nadhiri kwamba pindi nifikapo salama katika safari hii, ningemchinja kondoo aliyenona na kuutafuna mkia wake pamoja na maini yake kwa mchikicho wa kachumbari na achari. Papo kwa hapo, niliwaza kuwa nadhari hii haikustahili kwani ilikuwa ya kichoyo na ya kibinafsi.

Basi iliniwia niweke nadhiri nyingine kwamba nifikapo salama katika safari hii nitatoa zaka kuwapa maskini, wajane na mayatima. Mara moyo ulidunda nikawaza kwamba pengine ningepatwa

na ajali wakati wa kwenda tu. Nilionelea kwamba ni afadhali nizibakize baadhi ya zawadi hizo ili niwape maskini wa kwetu pia. Ni wazi kwamba nilitia shilingi elfu kumi katika mfuko wa hazina ya maskini na kanisa na hata misikiti iliyopakana na kiunga chetu.

Punde madubwasha yanayoiendesha ndege yalianza kutia makelele, nikahisi "leo ndiyo siku ya kiama" sote tulitulia tuli kama wafu, kila mmoja aliishika roho yake mkononi. Matumbo yalianza kuchezechesha; nyoyo zikadundadunda; macho yakapepesapepesa, kila mmoja akatokwa na jasho.

Utamu wa safari ya angani ulianza tulipoambiwa kwamba sasa tuifungue ile mikanda iliyokuwa imefungwa kuzuia matumbo yetu yasichezecheze au kutingizika. Hapo mambo yakawa shwari; tukaanza kutembeleana mumo humo katika ndege na kuulizana hali. Mara tuliangua vicheko. Vinywaji vilitapakaa katika ndege. Nyoyo zilitua.

Msomaji, usidanganyike; hakuna safari inayomatia msafiri woga zaidi ya safari ya angani, hasa ukifikiria kuhusu uhaba wa manusura kila ajali ya ndege inapotokea.

31. Safari iliyomatia mwandishi woga zaidi ni ile ya _____.
- A. Matlai na kusi
 - B. kusafiri angani
 - C. Vuli na masika
 - D. Heri na shari
32. Watu walisita kupanda ndege _____.
- A. Kwa sababu ya furaha ya kuwa angani
 - B. Kwa sababu ya woga wa ajali
 - C. Kwa sababu hawakuwa na nauli
 - D. Kwa sababu kutaka kusafiri kwa meli.
33. Mwandishi alisema sala;
- A. Baada ya kutulia katika ndege
 - B. Kabla tu ya kuabiri ndege
 - C. Ndege ilipoanza kutua
 - D. Matumbo yalipoanza kumtetemeka
34. Tulitembeleana katika ndege
- A. Baada ya kuabiri
 - B. Baada ya maombi
 - C. Ilipokuwa karibu kuondoka
 - D. Safari ilipofika mwisho
35. Kulingana na mwandishi:
- A. Manusura wa ajali za ndege huwa wachache
 - B. Abiria wote usafiri jongomeo
 - C. Katika abiria kumi na mmoja huokoka
 - D. Abiria wote huponea katika kila ajali
36. Mwandishi aliweka nadhiri ya kula mkia wa kondoo
- A. Arudipo salama
 - B. Akipata hela nyingi
 - C. Katika ndege
 - D. Asiporudi salama
37. Alama hii (;) imetumika sana kwenye kifungu. Alama yenyewe huitwa _____.
- A. Nukta
 - B. koloni
 - C. Nusu-koloni
 - D. Paradesi
38. "Maana ya kushikilia roho mkononi" ni _____.
- A. Kuwa na ujasiri
 - B. Kuwa na wasiwasi
 - C. Kuwa makinifu
 - D. Kuwa ange
39. Ulaya ni nchi gani kwa Kiingereza?
- A. Turkey
 - B. America
 - C. Europe
 - D. Portugal
40. Kichwa mwafaka cha makala haya ni _____.
- A. Msafiri kafiri
 - B. Roho Mkononi
 - C. Safari ya angani
 - D. Safari ya meli

Soma ufahamu ufuatao kisha ujibu swali la 41-50

Yakobo alizaliwa na wazazi wacha Mungu. Baba yake alikuwa askofu wa kanisa la New Heights Of Gospel International, NHGI). Askofu Mboni alikuwa maarufu sana kwa mahubiri yake kwenye redio na hata runinga za taifa. Ilitarajiwa kuwa maji yangefuata mkondo. Yakobo, mwanawe Askofu Mboni na tena wa pekee, alianza vizuri. Katika shule ya msingi ya Bukua alikuwa

mpole na mnyenyekevu. Masomoni alikuwa stadi. Sifa zake nzuri zilienea shuleni kote. Kila mwalimu alimpigia mfano.

Muda ulipita hadi akawa ameingia katika shule ya upili. Wakati huo teknolojia mpya ya mawasiliano ilikuwa imeshakita mizizi katika jamii ya vijana. Waliona kuwa walikuwa na dunia yao iliyokuwa tofauti na ile ya wazazi wao. Waliamini kuwa wavyele wao waliishi karne kumi zilizopita.

Yakobo alianza kupata alama chache masomoni. Hata siku moja mwalimu wake wa darasa alimwuliza, "Yakobo siku hizi una nini? Hupiti tena mtihani?" Yakobo alitabasamu akasema, "Mwalimu, tulia mambo yatakuwa mema."

Kilichoshangaza wanafunzi na hata walimu ni kuwa Yakobo alianza kuongea peke yake wakati mwingine. Macho yake yalikuwa kama yaliyotiwa pilipili na nywele hakuzichana. Hata alitisha kumpiga kila mwanafunzi aliyekaribu kumsaili kuhusu tabia yake mpya. Afya yake ilianza kudorora vilevile. Wazazi wake walialikwa shuleni siku moja, Yakobo akiwa kidato cha pili. Waliielezwa tabia ya mtoto wao hasa mabadiliko yake ya kisiha na kitabia. Askofu hakuyaamini aliyoambiwa. Mwanawe alikuwa shule ya bweni na hivyo aliamini aliyoambiwa kuhusu Yakobo yalikuwa mambo ya uongo. "Mtoto wangu, anayeongozwa na roho mtakatifu atafanyaje mambo hayo ya kishetani?" Alijiseema Askofu Mboni.

Haukupita muda mrefu sana. Maji yalizidi unga. Siku za mwizi ni arubaini. Usiku mmoja Yakobo alitoroka shuleni kwa kuruka ua akiwa na marafiki wake wawili. Walinaswa na mlinzi wa langoni punde waliporudi kutoka walikokwenda. Ajabu ni kuwa walikuwa na simu, misokoto ya bangi kadhaa na walikuwa wamelewa chopi. Asubuhi yake wazazi wao waliitwa shuleni. Kesi hiyo ilihusisha polisi ambao walifanya uchunguzi zaidi hasa kuhusu mihadarati. Yakobo na wenzake walipelekwa katika shule ya kurekebisha tabia. Kumbe wote walishafikia kiwango cha kuathiriwa. Yakobo aliishia kuwa mwendawazimu.

41. Ni jambo gani lililomfanya Mboni maarufu

- A. Mwanawe aliyekuwa maridhia
- B. Alikuwa mhubiri mwenye mali
- C. Alimiliki kampuni za redio na runinga
- D. Mahubiri yake katika vyombo vya habari

42. Iitarajiwa kuwa maji yafuate mkondo. Mwandishi alimaanisha?

- A. Yakobo alitarajiwa kuhubiri kama baba yake
- B. Mboni alitarajiwa kufuata mwenendo wa Yakobo
- C. Hulka ya Yakobo ilitarajiwa kuwa njema
- D. Tabia ya Yakobo ingekuwa ya kufuata wenzake

43. Kulingana na taarifa hii si kweli kusema

- A. Vijana waliwaona wazee kama watu wasiofahamu maisha ya sasa.
- B. Teknolojia mpya ilichangia mabadiliko ya Yakobo
- C. Yakobo alikuwa stadi masomoni
- D. Askofu Mboni alizaliwa karne nne zilizopita

44. Unadhani ni kwa nini Yakobo aliongea peke yake wakati mwingine?

- A. Aliongozwa na roho mtakatifu
- B. Ilikuwa dalili za madhara ya mihadarati.
- C. Alitembelewa na mashetani
- D. Hakupenda kumwona mwalimu darasani

45. Neno kumsaili limepigwa mstari. Ni nini maana ya neno hili _____.

- A. Kutaka kujua kwa kumhoji
- B. Kujaribu kumcheka Yakobo
- C. kumtania na kumtusi Yakobo
- D. Kumbembeleza Yakobo

46. Taarifa hii inaashiria kuwa _____.

- A. Teknolojia mpya inaweza kutumiwa vibaya
- B. Vijana wote huharibiwa na teknolojia mpya
- C. Macho ya Yakobo yalizoea kutiwa pilipili
- D. Askofu Mboni pia alitumia bangi

47. Maisha ya Yakobo yalifungua ukurasa mpya lini _____.

- A. Alipopita mtihani wake
- B. Alipokuwa katika shule ya upili
- C. Alipokuwa chuoni
- D. Baada ya baba yake kuyaamini aliyoambiwa na mwalimu

48. Ni bayana kuwa _____.

- A. Mboni aliyaamini malalamiko ya mwalimu na kumwonya mwanawe
- B. Yakobo alikamatwa na polisi alipotoroka shuleni
- C. Roho mtakatifu alimptosha Yakobo
- D. Athari za dawa za kulevya zilimtawala Yakobo

49. Yakobo na wenzake waliponaswa

- A. Bawabu aliwaadhibu sana
- B. Walikuwa na pombe kwenye chupa
- C. Mbio za sakafuni ziliishia ukingoni
- D. Kulikuwa mafungulia ng'ombe

50. Ni methali gani ingepigigwa Askofu Mboni

- A. Kitanda usichokilalia huwajui kunguni wake
- B. Maji hufuata mkondo
- C. Mtoto wa nyoka ni nyoka
- D. Mtaka cha mvunguni sharti ainame



KCPE TRIAL EXAMINATION

STANDARD EIGHT – 2015

SOCIAL STUDIES & CRE

Time: 2 hours 15 minutes

READ THESE INSTRUCTIONS CAREFULLY

1. You have been given the question booklet and a separate answer sheet. The question booklet contains 90 questions.
2. Do any necessary rough work in this booklet.
3. When you have chosen your answer, mark it on the **ANSWER SHEET**, not in the question booklet.

HOW TO USE THE ANSWER SHEET

4. Use an ordinary pencil only.
5. Make sure that you have written on the answer sheet.

YOUR INDEX NUMBER

YOUR NAME

NAME OF YOUR SCHOOL

6. By drawing a **dark line** inside the correct numbered boxes mark your full Index Number (i.e. School Code Number and the three-figure Candidate's Number) in the grid near the top of the answer sheet.
7. Do not make any marks outside the boxes.
8. Keep your answer sheet as clean as possible and do not fold it.
9. For each of the Question 1 – 90 four answers are given. The answers are lettered A, B, C and D. In each case only **ONE** of the four answers is correct. Choose the correct answer.
10. On the answer sheet the correct answer is to be shown by drawing a **dark line** inside the box in which the letter you have chosen is written.

EXAMPLE

In the Question Booklet:

32. Which of these lakes are formed when a river deposits sand materials on its banks?
- A. Tarns B. Fault lakes
C. Volcanic lakes D. Ox-bow lakes

The correct answer is D

On the answer sheet:

31 [A] [B] [C] [D] 32 [A] [B] [C] [D] 33 [A] [B] [C] [D] 34 [A] [B] [C] [D] 35 [A] [B] [C] [D]

In the set of boxes numbered 32, the box with the letter D printed in it is marked.

11. Your **dark line** **MUST** be within the box.
12. For each question **ONLY ONE** box is to be marked in each set of four boxes.

"For better grasp of the subject get yourself a copy of HIGH FLYER SERIES STD. 8 SOCIAL STUDIES, C.R.E AND I.R.E OR HIGH FLYER SERIES STD. 8 ENCYCLOPAEDIA.

Branded Eagle is a mark of genuine High Flyer Series Exams and Books. Beware of imitations.

© High Flyer Series, 2015

Tel. 0723 499860

TURN OVER

NEMA AREA

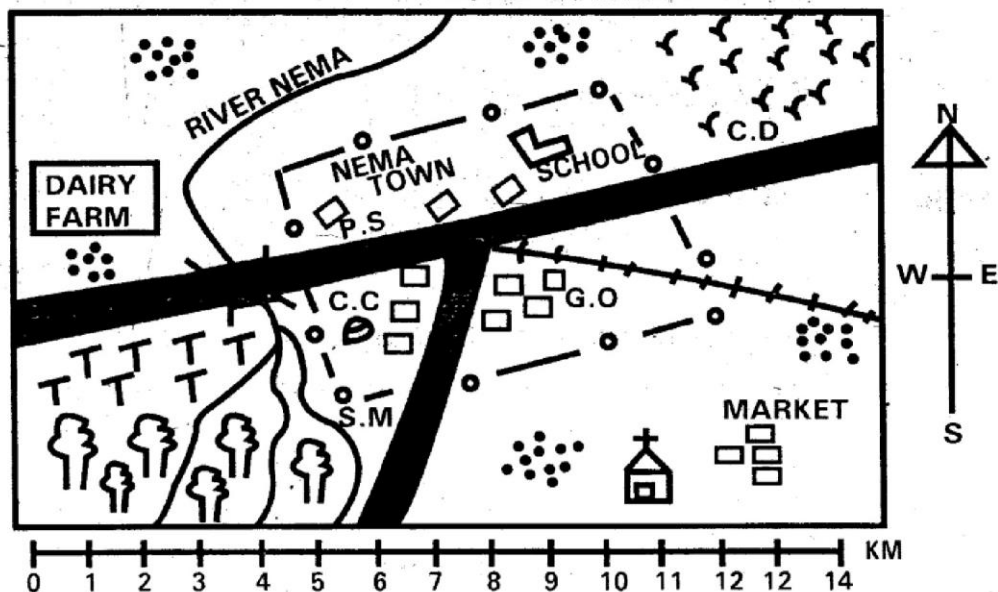

KEY

- | | |
|--|---|
| <ul style="list-style-type: none"> — TARMAC ROAD — RAILWAY LINE — TOWN BOUNDARY — TEA — GRASS — CHURCH C.C — CULTURAL CENTRE S.M — SAWMILL | <ul style="list-style-type: none"> P.S — POLICE STATION G.O — GOVERNOR'S OFFICE C.D — CATTLE DIP — PERMANENT BUILDINGS — SETTLEMENTS — FOREST |
|--|---|

Use the map of Nema area to answer questions 1 - 7

1. What is the approximate length of the tarmac road from the junction to the Eastern edge of the map?

A. 8 km	B. 20 km
C. 15 km	D. 16 km

2. Which of these parts of Nema area is likely to be at the highest altitude?

A. South-East	B. South-West
C. North-East	D. North-West

3. One of the following economic activities has been favoured by high altitude. Which one is it?

A. Trading
B. Rail transport
C. Cash crop farming
D. Tourism

4. The direction of the dairy farm from the church is _____.

A. South - East
B. North - East
C. South - West
D. North - West

5. One of the following statements is true about the settlements found in Nema area. Which one is it?

A. Most of the settlement are mainly found along river valleys
B. Most of the settlements are mainly found along the road
C. Most of the settlements appear in clusters
D. Most of the settlements are found in the town

6. Tourism activities are indicated in Nema town due to the presence of a _____.
- Police station
 - School
 - Governor's office
 - Cultural centre
7. Which of these statements about Nema area is FALSE?
- All parts of Nema area receive inadequate rainfall
 - Some parts of Nema area have red volcanic soils
 - Nema area is likely to be representing part of a county
 - There are more than two economic activities in the area represented by the map
8. Residual hills found mainly in the plateau areas of Africa are known as _____.
- Horsts
 - Inselbergs
 - Sand bars
 - Barchans
9. Which of these physical features is CORRECTLY matched with the country where it is located?
- Fouta Djallon plateau – Libya
 - Ahaggar plateau – Tunisia
 - Adamawa highlands – Cameroon
 - Cape Ranges – Botswana
10. One of these winds cause winter rain in the Cape Province of South Africa. Which one is it?
- The North – East winds
 - The Westerly winds
 - The South – East winds
 - The South – Westerlies
11. Which of these traditional methods of weather observation indicated absence of rainfall?
- Dark and thick clouds
 - Light and white clouds
 - The croaking of frogs
 - The coming of the new moon
12. The dry and wet bulb thermometer is an instrument used in measuring
- The humidity of a place
 - The atmospheric pressure of a place
 - The direction of the wind
 - The intensity of the sunshine
13. The sand spit, lagoons, sand bars and coral reefs are features found in _____.
- The African coastline
 - The semi desert areas of Africa
 - The desert areas of Africa
 - The plateau areas of Africa
14. Three of the following statements are true of the Rift Valley. Which one is NOT?
- All parts of the Rift Valley receive heavy and reliable rainfall
 - There are some volcanic features in the Rift Valley
 - There are some fresh water lakes in the Rift Valley
 - Temperatures in the Rift Valley vary according to the height above sea level
15. The capital city of Sierra Leone is known as _____.
- | | |
|----------------|---------------|
| A. Yamoussouko | B. Free town |
| C. Monrovia | D. Port Louis |
16. In which of these months is heavy rainfall experienced at the coast of Libya?
- March and May
 - June and July
 - July and September
 - December and January.
17. The following climatic conditions are experienced in a region of Africa.
- The region has wet and dry seasons
 - The regions humidity is high during the hot and wet season
 - Areas near the equator receive more rainfall than regions far away from the equator
- The climatic region described above is known as _____.
- Equatorial climate
 - Mediterranean climate
 - Savanna climate
 - Semi-desert climate
18. The Isthmuz of Suez joins two continents of the world. Which ones are they?
- Africa and Asia
 - Europe and South America
 - South America and North America
 - Africa and Europe

19. The following are causes of soil erosion. Which one is NOT?
- Bush fires
 - Poor cultivation methods
 - Mono cropping
 - Mulching
20. The following describes a type of soil found in Kenya
- It has large soil particles
 - It is found in some semi-arid parts of the country
 - It is saline
 - It is suitable for growing mangoes and cashew nuts
- The soil described above is _____
- Black cotton soil
 - Red volcanic soil
 - Sandy soil
 - Alluvial soil
21. Which of these lakes found in Africa is correctly matched with the method in which it was formed?
- Lake Albert – human activities
 - Lake Malawi – Glaciation
 - Lake Victoria – Volcanicity
 - Lake Bangweulu – Down warping
22. All the following mountains are volcanic origin except one. Which one is it?
- Mount Nyiragongo
 - Mount Oldonyo Lengai
 - Ahaggar Mountain
 - The Great Karas
23. The time at town J which is at 15° West is 8:00 p.m. What will be the longitude of town K when it is 10.00 p.m. there?
- 30° East
 - 30° West
 - 15° East
 - 45° East
24. Check dams are mainly built to control _____
- Sheet erosion
 - Splash erosion
 - Gulley erosion
 - Spatter erosion
25. The theory of human origin that is based on popular beliefs that explain natural or historical events amongst communities is known as _____
- The evolution theory
 - The mythical theory
 - The creation theory
 - The Darwin theory
26. Three of the following facts are true about Home Habilis. Which one is NOT?
- The creature was also named 'handy man'
 - The creature made simple speech
 - The creature could grasp an object between the fingers and the thumb
 - The creature walked upright
27. The Eastern Bantu of Kenya mainly left Shungwaya during their migration due to _____
- Attacks from a hostile community
 - Outbreak of diseases and epidemics
 - Drought and lack of pasture
 - Their spirit of adventure
28. Which of these sets of communities consists of only River-Lake Nilotes of Eastern Africa?
- Shilluk, Nandi and Sebei
 - Aramanik, Hawa and Luo
 - Alur, Langi and Dinka
 - Dinka, Njemps and sandawe
29. Three of the following communities are matched with their original place of origin except one. Which one is it?
- Warabai – Congo basin
 - Luo – Nile Valley in Sudan
 - Rendille – Horn of Africa
 - Amhara – south – West Africa
30. One of the following groups of people are mainly found in West Africa. Which one is it?
- Berbers, Hehe and Sotho
 - Temme, Dagomba and Kwahu
 - Zulu, Pygmies and Xhosa
 - Sotho, Lozi and Dendi
31. The movement of people from their country of birth to other countries is known as _____
- Immigration
 - Emigration
 - Naturalization
 - Dual citizenship
32. Which of these factors will lead to a slow population growth?
- Family planning
 - Improved medical care
 - Early marriages
 - Cultural practices

33. One of these countries is likely to have a high percentage of old people in its population structure. Which one is it?
 A. Kenya B. India
 C. Germany D. Nigeria
34. In the Hindu religious marriage
 A. Polygamy is allowed
 B. It is the groom who gets the dowry
 C. A man is allowed to marry a maximum four wives
 D. It is the bridegroom who gets the dowry
35. Planning for physical development in a public school in Kenya is the duty of _____
 A. The Deputy head teacher
 B. The senior teacher
 C. The school accountant
 D. The school committee
36. One negative effect of settler farming in Kenya was _____
 A. The introduction of machinery
 B. Congestion of Africans in the native reserves
 C. The establishment of towns
 D. The introduction of agricultural co-operatives
37. Which of these irrigation schemes is CORRECTLY matched with its source of water?
 A. Mwea-Tebere - River Thiba
 B. Perkerra - River Athi
 C. Bura-Hola - River Nzoia
 D. Ahero - River Mara
38. Horticultural farming in Netherlands is MAINLY practised in areas known as _____
 A. Schemes B. Dykes
 C. Polders D. Paddies
39. The following describes a crop grown in Africa
 (i) Requires heavy rainfall
 (ii) Requires warm temperatures
 (iii) Requires high humidity
 (iv) It cannot withstand strong sunlight when the plant is young
 (v) Requires shelter from strong winds
 (vi) Does well in low altitude
- The crop described above is _____
 A. Cocoa B. Pyrethrum
 C. Cotton D. Sisal
40. The Fulani are pastoralists found in the Sahel region of Africa. They move across the following countries except one. Which one is it?
 A. Senegal B. Nigeria
 C. Egypt D. Burkina Faso
41. Which of the following was not a reason for establishing the Aswan High Dam project?
 A. To provide water for irrigation
 B. To produce hydro-electric power
 C. To control the perennial floods
 D. To provide a permanent source of water for nomadic pastoralists
42. One of the following countries of Africa has the largest area under natural forests. Which one is it?
 A. Democratic Republic of Congo
 B. Swaziland
 C. Gabon
 D. Cote d'ivoire
43. In which of these African countries is the Great Usutu forest found?
 A. Namibia B. Botswana
 C. Lesotho D. Swaziland
44. The following towns are found in Africa
 (i) Elesa Eleme
 (ii) Port Harcourt
 (iii) Warri
 (iv) Kaduna
- All the above areas are major
 A. Gold producing areas in South Africa
 B. Cocoa producing areas in Nigeria
 C. Oil refining areas in Nigeria
 D. Copper producing areas of Zambia
45. Which of these sets of minerals are mainly obtained through the open-cast method?
 A. Diatomite and petroleum
 B. Soda ash and diatomite
 C. Limestone and fluorspar
 D. Limestone and salt
46. Which of the following comprises of manufacturing industries only?
 A. Lumbering, grain milling and tourism
 B. Textile industry, cement making and steel rolling mills
 C. Leather tanning, glass making and motor vehicle repair
 D. Bicycle assembly, plastic making and transportation

47. Marine fishing is carried out in the following countries except one. Which one is it?
- Gabon
 - Cameroon
 - Tanzania
 - Chad
48. The following are objectives of COMESA trading bloc except one. Which one is it?
- To create a common market for member states
 - To promote cooperation in transport and communication among member states
 - To establish a common bank to provide funds for investment in the member countries
 - To increase taxes in order to protect domestic markets in member states
49. Which of these highways found in Africa connects Benin with Morocco?
- The Cotonou – Gao – Oudja Highway
 - The Trans-Sahara Highway
 - The Great North Road
 - The Trans –Africa Highway
50. Three of the following countries are matched with their major tourist attraction sites. Which one is NOT?
- Egypt - Ancient city of Thebes
 - Tanzania – Slave market in Zanzibar
 - Senegal – Goree Island
 - Mauritius – Valley of Kings
51. The following relate to a traditional African community in Africa
- They believed in supreme God called Kagger
 - They recognized the praying mantis as God's symbol on earth
 - They lacked clearly defined laws

The community described above is known as _____.

- The Khoikhoi
- The San
- The Bambuti
- The Xhosa

Use the map of Africa to answer questions 52

- 54

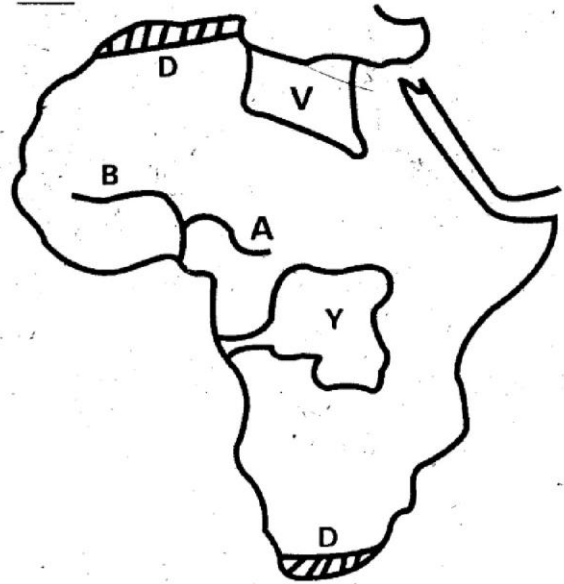

52. The rivers marked A and B are respectively known as _____.
- Benue and Niger
 - Niger and Senegal
 - Gambia and Niger
 - Volta and Senegal
53. The countries marked V and Y were respectively colonized by _____.
- France and Portugal
 - Portugal and Germany
 - Britain and Italy
 - Italy and Belgium
54. One of the following statements is true of the shaded climatic region marked D on the map. Which one is it?
- The region receives heavy rainfall during the summer season
 - The region receives heavy rainfall during the winter season
 - The region is cool and wet throughout the year
 - The region is hot and wet throughout the year
55. Samori Toure was able to resist French rule for a long time because of the following reasons except?
- He had a well disciplined army
 - He used Islam as a unifying factor among the people
 - He used the scorched earth policy
 - He had support from other Mande speaking communities

56. In which of the following African countries was indirect rule used by the British?
- Nigeria
 - Senegal
 - Zimbabwe
 - Angola
57. Which of the following does not amount to abuse of human rights?
- Bullying in schools
 - Torturing a suspected criminal
 - Arresting a suspected criminal
 - Denying pupils an opportunity to play in school
58. The following are members of the county executive committee in the county government except one. Whom is it?
- The governor
 - The deputy governor
 - The senator
 - A person appointed by the governor
59. The following are duties of the body in charge of elections in Kenya except one. Which one is it?
- Organizing and presenting certificates to winning candidates
 - Identifying the polling stations
 - Carrying out registration of voters
 - Nominating candidates on behalf of political parties
60. Which of these methods of resolving conflicts involves parties in dispute going to a court to have a judge or magistrate listening the cause of misunderstanding and making a decision?
- Litigation
 - Arbitration
 - Enquiry
 - Dialogue

CHRISTIAN RELIGIOUS EDUCATION

61. Adam and Eve disobeyed God in the garden of Eden when they _____.
- Talked to the serpent
 - Allowed the serpent to cheat them
 - Named the animals
 - Made clothes from vegetation
62. Jacob wrestled with an angel of God at one of the following places. Which one is it?
- Gilgal
 - Luz
 - Bethel
 - Peniel

63. Leah and Jacob were parents of _____.
- Rebecca
 - Zipporah
 - Dinah
 - Rahab
64. From the story of Joseph and Potiphar's wife Christians learn to _____.
- Run away from hostile masters
 - Exercise self-control in their lives
 - Work hard in order to gain promotion
 - Be obedient to their employers
65. Who among the following kings of Israel killed himself during the war against the Philistines?
- King Saul
 - King David
 - King Solomon
 - King Ahab
66. Three of the following were wives of king David of Israel except one. Whom is it?
- Bathsheba
 - Abigail
 - Michal
 - Bilhah
67. The following were promises of God to Abraham except one. Which one is it?
- To make him famous
 - To bless those who blessed him
 - To curse those who curse him
 - To make his descendants rule forever
68. According to Genesis 15:2 Abraham had a servant known as Eliezer who was from _____.
- Bethlehem
 - Gilgal
 - Damascus
 - Jericho
69. Who among the following women took a tambourine and led other women in dancing for the Lord after the Israelites crossed the Red Sea?
- Deborah
 - Miriam
 - Phoebe
 - Rahab
70. During the Passover in Egypt the Israelites marked their houses by smearing blood on _____.
- The roof of the houses
 - The door posts of the houses
 - The windows of their houses
 - The floor of their houses

71. Three of the following facts are true about Samson. Which one is NOT?
 A. He was a judge in Israel
 B. He was son of Manoah
 C. He was destined to be a Nazirite
 D. He was saved from the Philistines by Delilah
72. One characteristics of the New Covenant that God, promised through prophet Jeremiah that _____
 A. Every person will be punished for his or her own sins
 B. The laws of God would be written on a special book
 C. The laws of God would be written on scrolls
 D. It would be between Him and the Hebrews
73. According to Luke 9:1-6 Jesus sent His chosen twelve disciples with the following instructions except one. Which one is it?
 A. To heal those that were sick
 B. To stay wherever they were welcomed
 C. To carry food and money for their basic needs
 D. Not to stay where they were not welcomed
74. How many loaves of bread were used by Jesus when He fed a crowd of 4000 people?
 A. Six loaves
 B. Five loaves
 C. Seven loaves
 D. Four loaves
75. "My God, my God why did you abandon me?" On which occasion did Jesus say these words?
 A. During His baptism
 B. During His transfiguration
 C. During His crucifixion
 D. During His arrest
76. Which of these parables of Jesus is about persistence in prayer?
 A. A friend at midnight
 B. The parable of the sower
 C. The parable of the pearl
 D. The tax collector and the Pharisee.
77. One of the following was not done by Jesus Christ when He was on Earth?
 A. Making the water of Jericho pure
 B. Calming the storm
 C. Cleansing the temple
 D. Reading from a scroll in the Synagogue
78. In the story of the Good Samaritan the injured man belonged to one of the following communities. Which one is it?
 A. Samaritan community
 B. Greek community
 C. Hebrew community
 D. Persian community
79. Jesus met a rich tax collector from the town known as _____
 A. Jericho
 B. Nazareth
 C. Bethany
 D. Jerusalem
80. Blind Bartimaeus was healed by Jesus. He recognized Jesus as _____
 A. Son of God
 B. Son of man
 C. The saviour
 D. Son of David
81. Peter raised to life a woman who lived in _____
 A. Lydda
 B. Joppa
 C. Troas
 D. Bethany
82. The man healed by Peter and John at the Beautiful Gate in Jerusalem was _____
 A. Visually handicapped
 B. Mentally handicapped
 C. Hearing impaired
 D. Physically handicapped
83. All the following are Christian values except one. Which one is it?
 A. Chastity
 B. Charity
 C. Fame
 D. Spiritual poverty
84. As Christian we can use our leisure time in the following activities except one. Which one is it?
 A. Improving our talents
 B. Visiting the sick
 C. Talking about others
 D. Visiting those in prison

85. The early followers of Christ were first called Christians at Antioch. This place is in the present -day _____.
- Oman
 - Turkey
 - Israel
 - Spain
86. The early missionaries in Kenya did three of the following except?
- Introducing new crops in the country
 - Promoting hygiene habits
 - Translating the Bible into local languages
 - Promoting African cultural practices
87. The story of David and Jonathan teaches Christians the importance of _____.
- Loyalty
 - Humility
 - Peace
 - Courage
88. Which of the following traditional African practices is found in Christianity?
- Reconciling with enemies
 - Offering animal sacrifices
 - Offering libation to the ancestors
 - Praying to God through ancestors
89. One role of elders in traditional African communities was to _____.
- Predict future events
 - Give advice to the youth
 - Fight other communities during warfare
 - Treat the sick in the community
90. In both African traditional religion and Christianity
- It is believed that God has a son
 - It is believed that the Holy Spirit gives courage
 - There are sacred places for worshipping God
 - Charms and amulets are used for protection



KCPE TRIAL EXAMINATION

STANDARD EIGHT – 2015

MATHEMATICS



Time: 2 hours

READ THESE INSTRUCTIONS CAREFULLY

1. You have been given the question booklet and a separate answer sheet. The question booklet contains 50 questions.
2. Do any necessary rough work in this booklet.
3. When you have chosen your answer, mark it on the **ANSWER SHEET**, not in the question booklet.

HOW TO USE THE ANSWER SHEET

4. Use an ordinary pencil only.
5. Make sure that you have written on the answer sheet.

YOUR INDEX NUMBER

YOUR NAME

NAME OF YOUR SCHOOL

6. By drawing a **dark line** inside the correct numbered boxes mark your full Index Number (i.e. School Code Number and the three-figure Candidate's Number) in the grid near the top of the answer sheet.
7. Do not make any marks outside the boxes.
8. Keep your answer sheet as clean as possible and do not fold it.
9. For each of the Question 1 – 50 four answers are given. The answers are lettered A, B, C and D. In each case only **ONE** of the four answers is correct. Choose the correct answer.
10. On the answer sheet the correct answer is to be shown by drawing a **dark line** inside the box in which the letter you have chosen is written.

EXAMPLE

In the question Booklet

24. A cylinder has a volume of 831.6cm^3 . If the height of the cylinder is 15cm, what is the diameter? (Take $\pi = \frac{22}{7}$).

- A. 4.2cm B. 8.4cm
C. 55.44cm D. 0.42cm

The correct answer is **B**
On the answer sheet:

4 [A] [B] [C] [D] 14 [A] [B] [C] [D] 24 [A] [B] [C] [D] 34 [A] [B] [C] [D] 44 [A] [B] [C] [D]

In the set of boxes numbered 24, the box with the letter **B** printed in it is marked.

11. Your **dark line** **MUST** be within the box.
12. For each question **ONLY ONE** box is to be marked in each set of four boxes.

Branded Eagle is a mark of genuine High Flyer Series Exams and Books. Beware of imitations.



© High Flyer Series, 2015 Tel. 0723 499860

TURN OVER.

1. Which one of the following numbers is two hundred and four thousand and nine hundredths?
 A. 204,000.09
 B. 200400.09
 C. 204.09
 D. 204000.90

2. What is the value of $36 + 4(12 - 3^2) - 16 \times 8 \div 4$?
 A. 28
 B. 88
 C. 208
 D. 16

3. What is the total value of digit 3 in the number 94305281?
 A. 3000
 B. 30000
 C. 300000
 D. 3000000

4. What is 2995.098 when rounded off to two decimal places?
 A. 2996.00
 B. 2995.10
 C. 2995.09
 D. 3000.00

5. What is the value of $8(0.4^2 - 0.1^2) + 7.2 \div 2.4$?
 A. 15
 B. 12.3
 C. 3.72
 D. 4.2

6. What is the area of the shaded figure shown below?

Take $\pi = \frac{22}{7}$

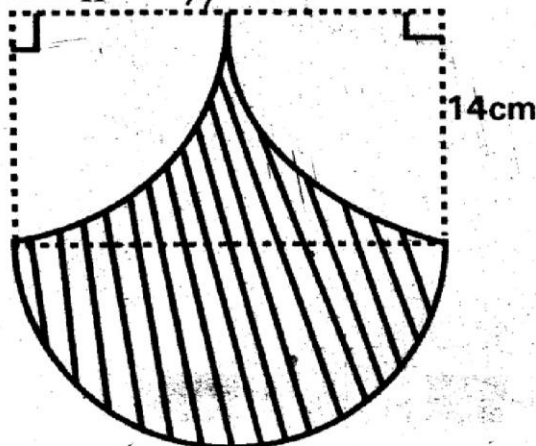

- A. 308cm^2
 B. 392cm^2
 C. 84cm^2
 D. 280cm^2

7. Which one of the following ratios represents 48%?
 A. 25:12
 B. 12:37
 C. 12:25
 D. 25:37

8. How many times must Mogaka cut a 12 metre sugarcane to share it among his four friends equally?
 A. 4
 B. 3
 C. 5
 D. 2

9. The fractions $\frac{5}{6}$, $\frac{3}{4}$, $\frac{5}{8}$ and $\frac{7}{10}$ are to be arranged in order from the smallest to the largest. Which one of the following is the correct order?

A. $\frac{5}{8}, \frac{7}{10}, \frac{3}{4}, \frac{5}{6}$

B. $\frac{5}{8}, \frac{3}{4}, \frac{7}{10}, \frac{5}{6}$

C. $\frac{5}{6}, \frac{3}{4}, \frac{7}{10}, \frac{5}{8}$

D. $\frac{5}{8}, \frac{7}{10}, \frac{5}{6}, \frac{3}{4}$

10. What is the value of $(5\frac{3}{4} - 2\frac{1}{3} + 2\frac{2}{3} \div \frac{8}{3}) \div \frac{5}{6}$

A. $4\frac{5}{12}$

B. $3\frac{49}{72}$

C. $2\frac{9}{10}$

D. $5\frac{3}{10}$

11. What is the value of $\sqrt{\frac{36+64}{(625-225)}}$ in simplified form?

A. $\frac{1}{2}$

B. $\frac{12}{5}$

C. $\frac{1}{4}$

D. $\frac{14}{15}$

12. Figure PQRS shown below is a parallelogram. Line RST is a straight line. Angle STU = 32° and angle TUP = 92°

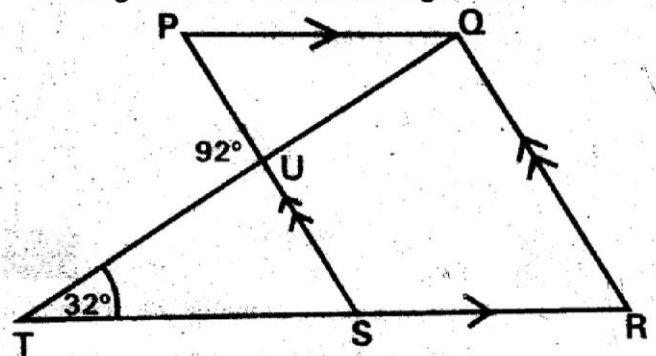

What is the size of angle TQR?

A. 92°

B. 60°

C. 88°

D. 120°

13. What is the value of $\frac{3n+t}{p}$ when $p = n + 2$, $p = 2t - n$ and $p = 6$?
- A. $4\frac{5}{6}$ B. $2\frac{5}{6}$
 C. $2\frac{1}{6}$ D. $4\frac{1}{6}$
14. A cylindrical water tank has a diameter of 1.4m and a height of 2.5m. How many litres of water will it hold when half full? (Take $\pi = \frac{22}{7}$)
- A. 3850 B. 3.85
 C. 38.5 D. 1925
15. The median of 8 numbers is 48. Seven of the numbers are 71, 73, 39, 29, 18, 53 and 63. Find the eighth number.
- A. 45 B. 46
 C. 43 D. 45
16. The perimeter of a right angled triangle is 80cm. Two sides of the triangle measure 16cm and 34cm. What is the area of the triangle?
- A. 240cm^2 B. 272cm^2
 C. 544cm^2 D. 360cm^2
17. The following are lengths of sides of different triangles:
- i. 9, 16, 25
 ii. 9, 40, 41
 iii. 11, 60, 61
 iv. 20, 21, 29
- Which one of the choices below contains all right angled triangles?
- A. (i), (ii), (iii) B. (i), (ii), (iv)
 C. (ii), (iii), (iv) D. (i), (ii), (iv)
18. Mokuia harvested 8 bags of wheat and 12 bags of maize. He sold each bag of wheat at sh 4800 and each bag of maize at sh 3200. How much money was left after paying sh 41,500 for medical bill?
- A. sh 76,800 B. sh 35,300
 C. sh 38,400 D. sh 118,300
19. What is the value of x in the equation $\frac{3}{4}(3x + 3) + 8 = 26$?
- A. 9 B. $14\frac{1}{9}$
 C. 5 D. 7

20. The figure below represents a flower garden

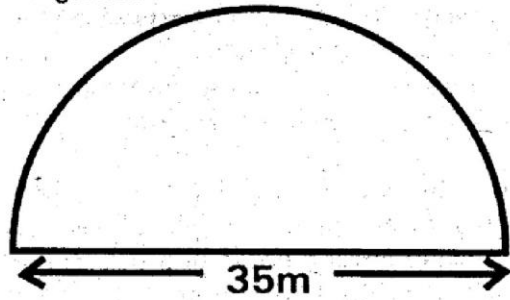

- It was fenced all round using poles placed 5m apart. How many poles were needed? (Take $\pi = \frac{22}{7}$)
- A. 18 B. 11
 C. 22 D. 29

21. The table below shows the number of candidates who sat for a certain examination in the years 2011 and 2012

GENDER	YEAR	
	2011	2012
Boys	345715	349406
Girls	329643	335795

- How many more candidates sat for the examination in 2012 than in 2011?
- A. 29683
 B. 16072
 C. 13611
 D. 9843

22. Okweba used $\frac{1}{12}$ of his land as homestead, $\frac{1}{4}$ for fruits, $\frac{2}{5}$ for maize and the remainder for pasture. If the area under pasture was 16ha, what was the area for fruits?
- A. 60ha
 B. 24ha
 C. 15ha
 D. 5ha
23. Mogeni and Omari shared a piece of sugarcane such that Mogeni got four times as much as Omari. What fraction of the sugarcane did Omari get?
- A. $\frac{1}{5}$ B. $\frac{1}{4}$
 C. $\frac{4}{5}$ D. $\frac{3}{4}$

24. Flour is packed in 3kg packets. If the weight of the flour in the packets is increased by 25%, what would be the new weight of the packet?

- A. 0.75kg B. 3.75kg
C. 2.25kg D. 4kg

25. Mukami had 215 two hundred shilling notes. She changed sh 14000 into one thousand shilling notes and the rest into five hundred shilling notes. How many five hundred shilling notes did he get?

- A. 43000 B. 72
C. 58 D. 29000

26. Semanya deposited sh 24,000 in a bank which paid interest at the rate of 12% p.a. How much did she have in the bank after six months?

- A. sh 1440
B. sh 25440
C. sh 26880
D. sh 41280

27. A cylinder has a height of 18cm. What is its diameter if its volume is 2772cm^3

(Take $\pi = \frac{22}{7}$)

- A. 14cm
B. 98cm
C. 49cm
D. 7cm

28. The table below shows the number of animals in Baraka's farm

ANIMAL	GOATS	SHEEP	COWS	PIGS	CAMELS
NUMBER	120	160	180	180	160

If the pie chart was to be drawn, what would be the size of angle representing goats?

- A. 120° B. 72°
C. 81° D. 54°

29. Okore bought a camera on hire purchase terms by paying a deposit of ksh 4,500 and equal monthly instalments of Ksh 2250 for $1\frac{1}{2}$ years. Calculate the marked price if the hire purchase price was 20% more than the marked price.

- A. sh 37,500
B. B. sh 45,000
C. sh 54,000
D. D. sh 33,750

30. The temperature of an object was -18°c . It was warmed until the temperature rose to 44°c . Find the rise in temperature.

- A. 26°c
B. 62°c
C. 52°c
D. 80°c

31. How many prime numbers are there between 70 and 100?

- A. 9 B. 8
C. 7 D. 6

32. Construct a triangle ABC such that $AB = 8\text{cm}$, $BC = 7\text{cm}$ and $\text{angle } ABC = 70^\circ$. Draw a circle touching the edges. What is the radius of the circle?

- A. 4.6cm B. 1.9cm
C. 2.3cm D. 3.4cm

33. What is the value of $\frac{2.88 \times 12.6 \times 10.8}{0.36 \times 0.54 \times 2.8}$

- A. 72
B. 720
C. 0.72
D. 7.2

34. Which of the following properties is TRUE about a square prism?

- A. It has 8 edges
B. It has 6 vertices
C. It has 5 vertices
D. It has 12 edges

35. What is the volume of the solid drawn below?

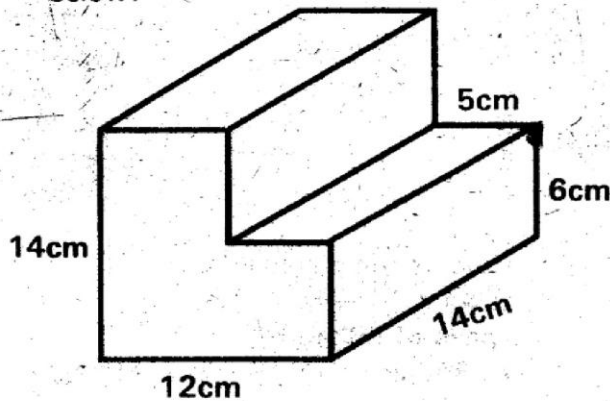

- A. 1792cm^3 B. 1932cm^3
 C. 1372cm^3 D. 2352cm^3
36. A mother is four times older than her daughter now. After eight years, the mother will be $2\frac{1}{2}$ times old than her daughter. How old is the daughter right now?
 A. 16 years B. 12 years
 C. 8 years D. 6 years
37. In a certain leap year, 13th of January was on a Sunday. What was 19th of March the same year?
 A. Thursday B. Monday
 C. Tuesday D. Wednesday
38. A shopkeeper paid sh 40800 for goods after a discount of 15%. How much would he have paid if the discount was 10%?
 A. sh 43,200 B. sh 44,880
 C. sh 42,228 D. sh 42,840
39. Eight workers take 12 days to dig a trench. How many more workers will be required in order to complete the work in 4 days?
 A. 24 B. 12
 C. 16 D. 6
40. When a businessman sells a plot for sh 450,000 he makes a 10% loss. How much should he sell it to make a 20% profit?
 A. sh 540,000 B. sh 600,000
 C. sh 675,000 D. sh 500,000
41. The charges of sending a telegram were sh 22.00 for the first ten words. Every additional word was charged sh 1.50. A tax of 18% is charged on the total and rounded off to the nearest five cent. Mutuku sent the telegram below:
 ONESMUS MWANZIA BOX 3784
 MBOONI MASAKU SEVENS
 SCHEDULED FOR JULY 6TH 2014
 MUTUKU NGUI
 How much money did he pay for the telegram?
 A. sh 33.00 B. sh 33.05
 C. sh 34.00 D. sh 33.50
42. A man left town Y for town P on Monday at 11.15pm. He took $8\frac{1}{4}$ hours to reach town P. On what day and at what time did he reach town P?
 A. Tuesday 7.30pm
 B. Monday 3.00am
 C. Monday 3.00pm
 D. Tuesday 7.30am
43. The distance from the main road to my house was to be planted with flowers on both sides. The flowers were to be 1.5m apart. If the distance from the main road to my house is 75 metres, how many flowers were planted?
 A. 50 B. 100
 C. 102 D. 51
44. Three candidates vied for a seat in an election. The winning candidate got a total of 64400 votes. The second candidate got 4874 votes less than the winning candidate. The third candidate got two third of what the second candidate got. If 933 votes got spoilt, how many votes were cast altogether?
 A. 164543 B. 162677
 C. 144701 D. 163610
45. Three men Kauka, Mrefu and Tumbo had some mangoes. Kauka had 30 mangoes less than Mrefu who had 75 more mangoes than Tumbo. If Tumbo had m mangoes, how many mangoes did they have altogether?

- A. $3m + 45$ B. $3m - 45$
 C. $3m + 120$ D. $3m - 120$

46. Ole Sumo used 0.7 of his money. He gave his wife 0.2 of the remainder and saved the rest. What percentage of his money did he save?

- A. 24% B. 6%
 C. 13% D. 10%

47. Kotut traveled from town A to town B a distance of 480km, at an average speed of 80km/h. He rested for one hour. He then continued traveling to town C at an average speed of 60km/h for 4 hours. What was the average speed used for the whole journey?

- A. 72km/h B. 66km/h
 C. 60km/h D. $65\frac{5}{11}$ km/h

48. The table below shows a bus time table from town A to town F

Town	Arrival Time	Departure Time
A		6.45am
B	8.25am	8.50am
C	10.10am	10.30am
D	11.45am	12.00 noon
E	1.30pm	2.00pm
F	2.40pm	3.20pm

What is the distance from town D to town E if the bus travelled at an average speed of 80km/h?

- A. 240km B. 140km
 C. 120km D. 160km

49. On a map, the length of a river which is 108km long is represented by a length of 12cm. What is the scale used?

- A. 1:9000000 B. 1:900000
 C. 1:90000 D. 1:9000

50. The graph shown below represents the journey of a motorist travelling from town K to L and back

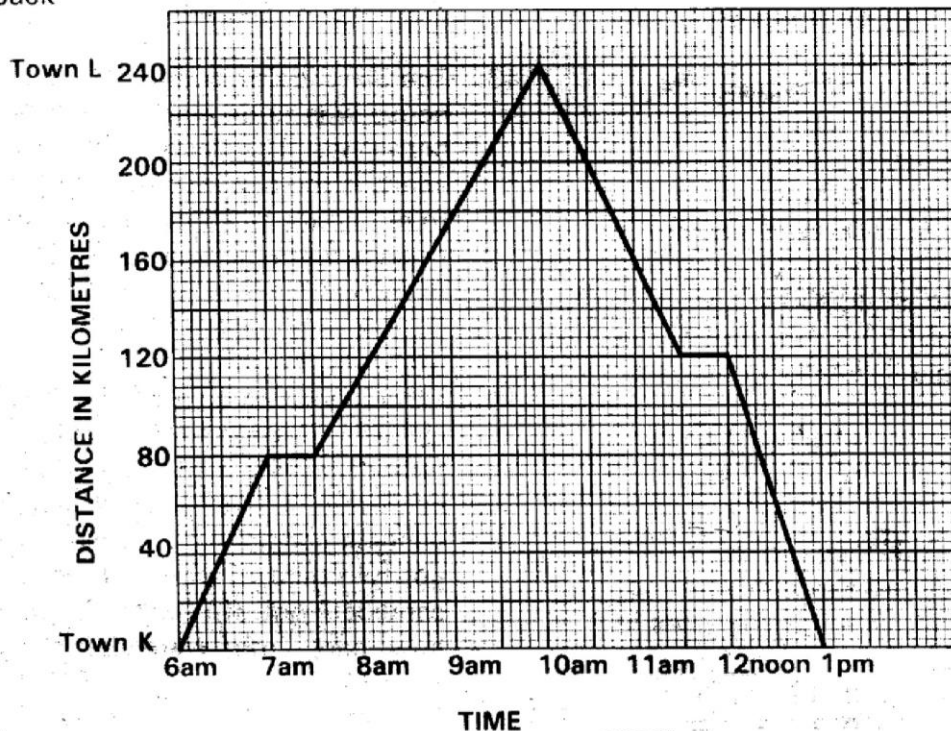

What was the average speed of the car for the whole journey?

- A. $34\frac{2}{7}$ km/h B. 80km/h
 C. $68\frac{4}{7}$ km/h D. 60km/h



**HIGH FLYER
SERIES
003**

**JARIBIO LA MTHANI WA KCPE
DARASA LA NANE – 2015
INSHA**

Muda: Dakika 40

NAMBA YAKO YA MTHANI	
JINA LAKO	
JINA LA SHULE YAKO	

SOMA MAAGIZO HAYA KWA MAKINI

1. Kwenye nafasi zilizoachwa hapo juu andika namba yako kamili ya mthani, jina lako na jina la shule yako.
2. Sasa fungua karatasi hii, soma kichwa cha insha kwa makini na uandike insha yako kwenye nafasi zilizoachwa.

Kijitabu hiki kina kurasa nane zimepigwa chapa.

**Kwa maelezo Mufti ya mbinu za uandishi wa insha pata nakala yako ya
"HIGH FLYER SERIES INSHA SHESHE"**

Branded Eagle is a mark of genuine High Flyer Series Exams and Books. Beware of imitations.



© High Flyer Series, 2015 Tel. 0723 499860 Fungua kurasa

ANDIKA INSHA YA KUSISIMUA UKIMALIZIA KWA MANENO HAYA:

Hapo ndipo nilipoamini kuwa, mwenda tezi na omo marejeo ni ngamani.



**HIGH FLYER
SERIES
003**

**KCPE TRIAL EXAMINATION
STANDARD 8 – 2015
COMPOSITION**

Time: 40 minutes

YOUR INDEX NUMBER	
YOUR NAME	
NAME OF YOUR SCHOOL	

READ THESE INSTRUCTIONS CAREFULLY

1. In the spaces provided above write your full-Index Number, Your Name and Name of your school.
2. Now open this paper read the composition subject carefully and write your composition on the lines provided.

This Question Paper consists of 4 printed pages.

For tips on how to write best compositions, get a copy of "HIGH FLYER SERIES COMPOSITION"

Branded Eagle is a mark of genuine High Flyer Series Exams and Books. Beware of imitations.



© High Flyer Series, 2015 Tel. 0723 499860

TURN OVER

"For better grasp of the subject get yourself a copy of HIGH FLYER SERIES STD. 8 ENGLISH OR HIGH FLYER SERIES STD. 8 ENCYCLOPAEDIA."

Below is the beginning of a story. Complete it making it as interesting as possible.

Munyua and Kio were dressed to kill. They hurried to join their family who were already seated in the van they were travelling in

STANDARD 8 - 2015

COMPOSITION

HIGH FLYER

SERIES

003

Time: 40 minutes

YOUR INDEX

NUMBER

YOUR NAME

NAME OF YOUR

SCHOOL

READ THESE INSTRUCTIONS CAREFULLY

1. Read the question carefully and write your answer in the space provided. Your Name and Name of School.

The Question Paper consists of 4 printed pages

2. For the purpose of this examination, you are to write the best composition. Get a copy of "HIGH FLYER SERIES COMPOSITION".

3. The question paper consists of 4 printed pages. Read the instructions carefully and write your answer in the space provided.

High Flyer Series, 2015 Vol. 0723 498860

TURN OVER

4. For further information of the subject get yourself a copy of HIGH FLYER SERIES STD. 8 ENGLISH OR HIGH FLYER SERIES STD. 8 ENCYCLOPEDIA



HIGH FLYER TRIAL EXAM 2015

STANDARD EIGHT

MARKING SCHEME

ENGLISH	KISWAHILI	MATHS	SCIENCE	SOCIAL STUDIES	
1. A	1. B	1. A	1. A	1. A	51. B
2. C	2. D	2. D	2. C	2. B	52. A
3. B	3. B	3. C	3. B	3. C	53. D
4. D	4. B	4. B	4. A	4. D	54. B
5. B	5. A	5. D	5. B	5. C	55. D
6. A	6. A	6. B	6. D	6. D	56. A
7. A	7. D	7. C	7. C	7. A	57. C
8. D	8. B	8. B	8. B	8. B	58. C
9. C	9. A	9. A	9. D	9. C	59. D
10. C	10. B	10. D	10. B	10. B	60. A
11. C	11. B	11. A	11. C	11. B	
12. D	12. B	12. C	12. A	12. A	C.R.E
13. D	13. A	13. B	13. D	13. A	61. B
14. A	14. A	14. D	14. C	14. A	62. D
15. B	15. C	15. C	15. C	15. B	63. C
16. B	16. B	16. A	16. B	16. D	64. B
17. B	17. C	17. C	17. B	17. C	65. A
18. C	18. A	18. B	18. A	18. A	66. D
19. C	19. C	19. D	19. C	19. D	67. D
20. A	20. A	20. A	20. B	20. C	68. C
21. D	21. B	21. D	21. D	21. D	69. B
22. D	22. C	22. C	22. A	22. D	70. B
23. D	23. B	23. A	23. A	23. C	71. D
24. A	24. A	24. B	24. C	24. C	72. A
25. D	25. C	25. C	25. B	25. B	73. C
26. A	26. C	26. B	26. A	26. D	74. C
27. A	27. B	27. A	27. D	27. A	75. C
28. B	28. B	28. D	28. D	28. C	76. A
29. B	29. D	29. A	29. A	29. D	77. A
30. A	30. B	30. B	30. B	30. B	78. C
31. C	31. B	31. D	31. C	31. B	79. A
32. C	32. B	32. C	32. B	32. A	80. D
33. D	33. A	33. B	33. D	33. C	81. B
34. C	34. D	34. D	34. C	34. B	82. D
35. D	35. A	35. A	35. C	35. D	83. C
36. C	36. A	36. C	36. B	36. B	84. C
37. B	37. C	37. D	37. D	37. A	85. B
38. D	38. B	38. A	38. B	38. C	86. D
39. A	39. C	39. C	39. B	39. A	87. A
40. A	40. C	40. B	40. C	40. C	88. A
41. A	41. D	41. B	41. A	41. D	89. B
42. B	42. C	42. D	42. C	42. A	90. C
43. B	43. D	43. C	43. C	43. D	
44. C	44. B	44. A	44. B	44. C	
45. D	45. A	45. C	45. D	45. C	
46. A	46. A	46. A	46. A	46. B	
47. B	47. B	47. D	47. C	47. D	
48. D	48. D	48. C	48. B	48. D	
49. C	49. C	49. B	49. A	49. A	
50. C	50. A	50. C	50. C	50. D	
					I.R.E
					1. D
					2. C
					3. C
					4. D
					5. A
					6. B
					7. D
					8. C
					9. C
					10. C
					11. C
					12. A
					13. D
					14. B
					15. A
					16. A
					17. A
					18. C
					19. D
					20. D
					21. D
					22. C
					23. A
					24. B
					25. C
					26. C
					27. A
					28. C
					29. A
					30. C