

ENGLISH: SECTION A: LANGUAGE STANDARD EIGHT - 2015

INSTRUCTIONS TO CANDIDATES (Read these instructions carefully.)

1. You have been given this question booklet and a separate answer sheet. The question booklet contains 50 questions.
2. Do any necessary rough work in this booklet.
3. When you have chosen your answer, mark it on the **ANSWER SHEET**, not in the question paper.

HOW TO USE THE ANSWER SHEET.

4. Use an ordinary pencil only.
5. Make sure that you have written on the answer sheet:-

YOUR INDEX NUMBER

YOUR NAME

NAME OF YOUR SCHOOL

6. By drawing a **dark line** inside the correct numbered boxes, mark your full Index Number (i.e. School Code Number and the three-figure Candidate's Number) in the grid near the top of the answer sheet.
7. Do not make any marks outside the boxes.
8. Keep your answer sheet as clean as possible and **DO NOT FOLD IT**.
9. For each of the questions 1-50, four answers are given. The answers are lettered A, B, C, D. In each case, only **ONE** of the four answers is correct. Choose the correct answer.
10. On the answer sheet, show the correct answer by drawing a **dark line** inside the box in which the letter you have chosen is written.

Example:

For questions 21 and 24, choose the best word to fill in the blank space.

23. Pupils _____ be careful with the company they keep.

- A. could
- B. should
- C. can
- D. ought

The correct answer is B.

On the Answer sheet:

21. [A] [B] [C] [D] 22. [A] [B] [C] [D] 23. [A] [B] [C] [D] 24. [A] [B] [C] [D]

In the set of boxes number 23, the box with letter **B** printed in it is marked.

11. Your dark line **MUST** be within the box.
12. For each question, **ONLY ONE** box is to be marked in each set of four boxes.

This question paper consists of 7 printed pages.

*Published and printed by Targeter Educational Publishers Ltd.
Email: exams@targeterpublishers.co.ke*

TURN OVER

Questions 1 to 15

Read the passage below carefully. it contains blank spaces numbered 1 to 15. For each blank space, choose the best answer from the choices given.

Many people all over the world still smoke 1 it is common 2 that smoking is dangerous to health. This is because the nicotine 3 in 4 has been 5 to be 6. Many young people get introduced to this 7 through peer pressure, by aping 8 peers or the celebrities they watch on TV advertisements.

Today smokers give 9 reasons for maintaining this practice. They say cigarettes are useful stimulants and that they give the smokers something to do with their hands. 10 the most important cause 11 the increase in smoking is that it provides shared experience among the peer group and this continues even after it becomes a settled habit. At what point it actually becomes a habit difficult to 12, is not possible to tell. The 13 campaign through advertisements has made things 14. Manufacturers 15 that smoking provides employment.

- | | | | | |
|-----|----------------|---------------|----------------|------------------|
| 1. | A. however | B. despite | C. although | D. nevertheless |
| 2. | A. knowledge | B. education | C. information | D. sense |
| 3. | A. got | B. found | C. extracted | D. removed |
| 4. | A. ciggarettes | B. sigarettes | C. cigarettes | D. cigarretes |
| 5. | A. proven | B. proved | C. proof | D. profed |
| 6. | A. poisonous | B. deadly | C. enjoyable | D. addictive |
| 7. | A. tradition | B. custom | C. practise | D. habit |
| 8. | A. their | B. there | C. some | D. most |
| 9. | A. few | B. various | C. a few | D. a lot |
| 10. | A. Indeed | B. In fact | C. Surely | D. Perhaps |
| 11. | A. of | B. to | C. for | D. off |
| 12. | A. shake away | B. shake over | C. shake off | D. shake through |
| 13. | A. boring | B. aggressive | C. monotonous | D. irrelevant |
| 14. | A. worse | B. bad | C. more worse | D. worst |
| 15. | A. say | B. declare | C. confess | D. argue |

For questions 16 and 17, remove one letter from the given word, then choose the one closest in meaning from the choices given.

16. LAID
A. aid
B. help
C. disease
D. like.

17. LEAST
A. West
B. start
C. final
D. begin.

For questions 18 and 19, choose the correct alternative to complete the given sentences.

18. You either give me my pencil _____
A. since you will face my mother's wrath.
B. than face my mother's wrath.
C. nor face my mother's wrath.
D. or face my mother's wrath.
19. No sooner had father arrived home _____
A. than mother told him about the stranger.
B. when mother told him about the stranger.
C. and mother told him about the stranger.
D. suddenly mother told him about the stranger.

For questions 20 and 21, choose the word that is opposite in meaning of the underlined word.

20. Mr. Mwenge was known to be a miser.
A. wise
B. spendthrift
C. idler
D. saver.

21. The pupils' ignorance shocked the teacher.
A. ability
B. brightness
C. dullness
D. knowledge.

For questions 22 and 23, complete the given proverbs correctly.

22. Ignorance,
A. is a disease
B. is bliss
C. has no cure
D. should be fought.

23. Every cloud,
A. is grey
B. hangs loosely
C. has a silver lining
D. carries rain.

In questions 24 and 25, choose the sentence that is grammatically correct.

24. A. The goat was tied to a tree.
B. River Nile is the longest in Africa.
C. Can you translate English to Kiswahili.
D. Most girls are fond to Mariam.
25. A. Do you mind to bring me a cup of water?
B. Have you finished to use my pen?
C. Don't write with ink.
D. We were warned against cheating.

Read the passage below carefully and then answer questions 26 to 38.

Before a farmer starts fish farming, there are several basic considerations to ensure success. These include the pond design, the species of fish and fish feeds.

The general rule is that the pond water inflow and outflow should equal the pond volume over the period of a month. If the inflow is too low, water quality may suffer from oxygen depletion and accumulation of toxins. If the water outflow is too high, large amounts of beneficial algae may be flushed out from the pond.

Place screens on pond inlets and outlets to keep out predators, insects and unwanted fish and also to retain the cultured fish.

Relatively shallow ponds are productive. However, the shallow end should be at least 0.5m deep to avoid invasion by weeds and predation of the fish. The size and shape of the pond can vary depending on the fish species, population and the farmer's preferences.

It's worth noting that if you want to produce fingerlings, you will require more small ponds whereas a food fish producer requires relatively large ponds.

The bottom must have a sufficient slope for good drainage. If the slope is too gentle, the pond will not be easily drained. If the pond is too steep, it may be too shallow at one end or too deep at the other end. The pond should be drainable.

The perimeter and feeder roads are required for movement of machines during construction and harvest. If you plan to drive on the dykes, build them at least 3m wide on top and at the base. Top soil is high in organic material and should not be used to construct pond dykes. Land should be composed of good quality soil, with little or no gravel or rocks either on the surface or mixed in. Areas with rocky, gravelly or sandy soil are not suitable for pond construction. Soil that will be used to build the dykes must contain at least 20 percent clay so that the finished pond will hold water throughout the growing period.

There are three major fish species which can do well in the Kenyan climatic conditions. They are Nile Tilapia, African catfish and Trout.

26. From the first paragraph of the passage, we can say that,
- A. fish farmers always think of being successful
 - B. a fish farmer must consider the type of fish, the pond design and fish feeds to ensure success
 - C. the main consideration for a fish farmer is the pond design
 - D. most fish farmers are successful.

27. Which of the following statements is not true?
- A. The amount of water flowing into the pond should be low.
 - B. Low inflow can lead to low oxygen levels.
 - C. Algae is beneficial in water ponds.
 - D. A pond should have an inlet and an outlet.

28. The word toxins as used in the passage could mean?
 A. Bacteria.
 B. Algae.
 C. Poisons.
 D. Dirt.
29. Screens are important in order to,
 A. to let in beneficial algae
 B. keep out the cultured fish
 C. allow in useful insects
 D. protect fish.
30. From the fourth paragraph, we can conclude that,
 A. only, shallow ponds are productive
 B. the size and shape of the pond depend on several factors
 C. the shallow end of a pond should not be more than 0.5m deep
 D. weeds predate on fish.
31. The word predator has been used in the passage its opposite is,
 A. parasite
 B. insect
 C. prey
 D. hunter.
32. The phrase 'it's worth noting that...' as used in the passage means,
 A. the fact is important
 B. it's a special point
 C. the point is unique
 D. the point should be ignored.
33. Why do you think a subsistent fish farmer needs a big pond?
 A. The fish are many.
 B. To attract customers from far and beyond.
 C. To earn interest from the buyers.
 D. The fish grow big in size thus need more space.
34. Which of the following types of soil helps in water retention?
 A. To soil.
 B. Gravel.
 C. Loam.
 D. Clay.
35. A shallow pond is likely to,
 A. dry up easily
 B. suffer poor drainage
 C. attract animals that feed on the fish and weeds
 D. give poor yields.
36. A fish pond should be near,
 A. a water source
 B. a dyke
 C. the main road
 D. the market.
37. Which of the following is not a fish type mentioned in the story?
 A. Tilapia.
 B. Catfish.
 C. Mud fish.
 D. Trout.
38. The best title for the passage could be,
 A. A successful fish farmer.
 B. Fish farming in Kenya.
 C. Fish feeds.
 D. Successful fish farming.

Read the passage below carefully and then answer questions 39 to 50.

In days of yore, all animals lived together happily under the able leadership of king Elephant. No animal hunted the other for food although they had a common enemy- man. Man whose thin skin could not protect him from the harsh weather had been reluctantly allowed to go and live alone by the king.

As he moved away, man was elated but scared. He therefore could not go far and so he settled at the edge of the forest. He built himself a hut and embarked on crop farming. As luck would have it, he harvested plenty of crops at the end of every season. With plenty to eat, his family thrived in leaps and bounds.

One day, cat, dog, goat and sheep bumped into his home and henceforth became his constant visitors. Man who was very generous did not see any big deal in giving them food to eat and even carry back to their families. Donkey who soon joined them unlike the others, saw leadership qualities in man.

Several years later, a long period of drought hit the land streams and wells dried up except one. Elephant gave a directive that no animal should drink more than once a day but for him and his family. No animal, however, took notice of the order. The animals became very angry and hungry by the day. They talked to man who agreed to present their grievances to Elephant.

King Elephant refused to listen to them and chased all of them away. That very day, the king and his family invaded man's farm eating all the crops they could and destroying what was too small for them. When man saw this, he was angry and moved away from the forest edge but vowed to return one day to revenge. It took him several days to reach the first human settlement.

He soon built a better shelter and learnt how to make weapons. Accompanied by his fellow men, man returned to the animal kingdom on a revenge mission. They shot at all the other animals except cat, dog, horse, donkey, cow, goat and sheep.

To date, elephant comes out at night to destroy man's crops while he in turn, shoots elephant if seen.

39. Which of the following statements is true according to the first sentence?
- A. Today all animals live happily together.
 - B. Long ago animals lived as a family.
 - C. The elephant is the king of the jungle.
 - D. The animals love their king.
40. Man is likely to have,
- A. been sent away from the jungle
 - B. rebelled against elephant's leadership
 - C. lived with the other animals in the forest before
 - D. disliked the other animals.
41. The word reluctantly as used in the passage could be replaced by all the following words except?
- A. Willingly.
 - B. Grudgingly.
 - C. Hesitantly.
 - D. Unwillingly.

42. As a result of fear man,
A. went far away from the forest
B. looked for human settlement
C. did not go far away from the forest
D. took dog with him to guard him.
43. The phrase '*in leaps and bounds*' as used in the second paragraph means,
A. in large amounts
B. very fast
C. in stages
D. unexpectedly.
44. What in the passage shows that man was generous?
A. He harvested plenty of food.
B. He accepted to talk to elephant.
C. He always had visitors.
D. He fed the animals and gave him food to carry.
45. Elephants order shows that he was,
A. economical
B. mean
C. kind
D. selfish.
46. Why do you think the animals disobeyed Elephants directive?
A. They were stubborn.
B. They wanted to provoke the king.
C. They had no alternative.
D. Man incited them.
47. How many animals are mentioned in the story?
A. Five.
B. Six.
C. Eight.
D. Seven.
48. Elephant and man can be described as,
A. strong
B. creative
C. friendly
D. vengeful.
49. Why do you think cat, dog, horse, donkey, cow, goat and sheep were spared by man?
A. Thy disliked elephant.
B. They were man's friends.
C. They were man's spies.
D. They pleaded for mercy.
50. The best title for the story could be,
A. Man and his family.
B. How some animals became domestic animals.
C. How man and Elephants became enemies.
D. The fall of Elephant's kingdom.

KISWAHILI : SEHEMU YA KWANZA : LUGHA DARASA LA NANE - 2015

MAAGIZO KWA WATAHINIWA

SOMA MAAGIZO YAFUATAYO KWA MAKINI.

1. Umepewa kijitabu hiki cha maswali na karatasi ya kujibia. Kijitabu hiki kina maswali 50.
2. Ikiwa utataka kuandika chochote ambacho si jibu, andika katika kijitabu hiki.
3. Ukiisha kuchagua jibu lako, lionyeshe katika **KARATASI YA MAJIBU** na wala **sio** katika kijitabu cha maswali.

JINSI YA KUTUMIA KARATASI YA MAJIBU.

4. Tumia penseli ya kawaida.
5. Hakikisha ya kwamba umeandika yafuatayo katika karatasi ya majibu:

NAMBARI YAKO YA MTIHANI
JINA LAKO
JINA LA SHULE YAKO

6. Kwa kuchora kistari katika visanduku vyenye namba zinazokuhusu, onyesha namba yako kamili ya mtihani (yaani nambari ya shule, na zile namba tatu za mtahiniwa) katika sehemu iliyotengwa mwanzo wa karatasi ya majibu.
7. Usitie alama zozote nje ya visanduku.
8. Iweke safi karatasi yako ya majibu, na usiikunje.
9. Kwa kila swali 1-50, umepewa majibu manne. Majibu hayo yameonyeshwa kwa herufi **A, B, C, D**. Ni jibu **MOJA** tu kati ya hayo manne ambalo ni sahihi. Chagua jibu hilo.
10. Kwenye karatasi ya majibu, jibu sahihi lionyeshwe kwa kuchora kistari katika kisanduku chenye herufi uliyochagua kuwa ndilo jibu.

Mfano

Katika kijitabu cha maswali:

19. Bangili ni kwa mkononi kama vile kikero ni kwa _____
A. masakioni
B. puani
C. shingoni
D. miguuni.

Jibu sahihi ni **B**

Katika karatasi ya majibu

16. [A] [B] [C] [D]

17. [A] [B] [C] [D]

18. [A] [B] [C] [D]

19. [A] [B] [C] [D]

19, kisanduku chenye herufi **B** ndicho kilichochoywa kistari.

11. Chora kistari chako vizuri. Kistari chako kiwe cheusi na kisijitokeze nje ya kisanduku.

12. Kwa kila swali, chora kistari katika kisanduku **kimoja** tu kati ya visanduku vinne ulivyopewa.

Kijitabu hiki cha maswali kina kurasa 7 zilizopigwa chapa.

Maswali 1 mpaka 15.

Soma vifungu vifuatavyo. Vina nafasi 1 mpaka 15. Umepeva majibu manne hapo. Chagua jibu lifaalo zaidi kati ya yale uliyopewa.

1 UKIMWI, gonjwa la Ebola limetukia kuwa hatari kwa maisha ya binadamu. Matabibu na wauguzi 2 hawajasazwa na ugonjwa huu. Nchi 3 raia wake ziliweka 4 usafiri na kufunga mipaka yao. Nchi za magharibi 5 Afrika 6 na janga hili zaidi. Nchi zilizofunga mipaka yao zilielewa kuwa 7 . 8 nchi ya Liberia iliathiriwa zaidi.

- | | | | | |
|----|--------------------------------------|---------------------------------------|-----------------------------------|-----------------------|
| 1. | A. Bali na | B. Katika ya | C. Kando ya | D. Mbali na |
| 2. | A. tunategemea | B. tunaowategemea | C. tunayowategemea | D. tunaitegemea |
| 3. | A. zinazoithamini | B. zinazodhamini | C. zinazothamini | D. inayothamini |
| 4. | A. vikwazo vya | B. makataa ya | C. vifungo vya | D. migomo ya |
| 5. | A. mwa | B. ya | C. za | D. cha |
| 6. | A. ndiyo iliyokumbwa | B. ndilo lililokumbwa | C. ndio zilizokumbwa | D. ndizo zilizokumbwa |
| 7. | A. mwenzio akinyolewa chako tia maji | B. mzigo wa mwenzio ni kanda la usufi | C. maji ya kifuu bahari ya chungu | D. yajapo yapokee |
| 8. | A. Yamkini | B. Kwa yakini | C. Kwa biyyo | D. Kwa kuwa |

Mwelekeo 9 wa Kombo kuhusu semo la Kiswahili 10 kubadilika 11 motisha aliyopata kwa mwalimu wake. Sauti ghuna kama vile; 12 hazikuwa tatizo tena 13 hadi akafahamu vielezi vya jinsi yaani; 14 na vingine vingi. Sehemu ya insha 15 miongoni mwa sehemu zilizomatiza bali pia matamshi yake.

- | | | | | |
|-----|---------------------------|---------------------------|-------------------------------|---------------------------|
| 9. | A. hasi | B. chanya | C. mzuri | D. zuri |
| 10. | A. lilizidi | B. ulizidi | C. ilizidi | D. kilizidi |
| 11. | A. kutokana kwa | B. kutoka kwa | C. kutokana na | D. kutoka na |
| 12. | A. t, b, g | B. h, b, s | C. p, t, k | D. b, d, g |
| 13. | A. Alipiga upwete | B. Alilaza damu | C. Alijifunga masombo | D. Alijifunga tongo |
| 14. | A. kwa gari, ovyo, ghafla | B. upesi, polepole, mtoni | C. kishujaa, kitini, darasani | D. alasiri, jioni, kisiri |
| 15. | A. sicho | B. sio | C. siyo | D. sizo |

Kutoka swali la 16 mpaka 30. chagua jibu lililo sahihi.

16. Chagua jawabu sahihi:

- A. Dohani ni bomba la kupitisha moshi.
- B. Ukoko ni chakula kinacholala hadi asubuhi.
- C. Mwiki ni mabaki ya chakula kinachoganda kwenye sufuria.
- D. Kuinjika ni ^{nyondo}chungu kwenye jiko.

17. Kinyume cha sentensi;

Mjakazi ameo shangazi.

- A. Mtwana ametaliki halati.
- B. Mjakazi hajao shangazi.
- C. Kitwana ametaliki halati.
- D. Mtwana ametaliki mjomba.

18. Chagua sentensi iliyoandikwa katika kauli ya kutendesha.

- A. Mtoto amenawishwa mikono yake.
- B. Mtoto amenavya mikono yake.
- C. Mtoto alinawia karoni.
- D. Mtoto amenawa mikono yake.

19. Chagua wingi wa;

Uuguzi umesitishwa kwa muda

- A. Uuguzi umesitishwa kwa muda.
- B. Wauguzi wamesitishwa kwa mida.
- C. Mauguzi yamesitishwa kwa mida.
- D. Mauguzi yamesitishwa kwa muda.

20. Alama ya barabarani yenye picha ya watoto inamaanisha watoto wanaweza,

- A. kuwa wanapita wakati wowote
- B. kupita wakiona alama hiyo
- C. kupita wakiona gari
- D. kusimama wakiona alama hiyo.

21. Mtu anayeishi na kulia mahali alipozaliwa ni;

- A. mlowezi
- B. mkazi
- C. mzalia
- D. mwenyeji.

22. Chagua sentensi yenye kimilikishi katika nafsi ya tatu.

- A. Vitabu vyetu vina picha nzuri.
- B. Vitabu vyao vina picha nzuri.
- C. Vitabu hivyo vina picha nzuri.
- D. Vitabu vyenu vina picha nzuri.

23. Ikiwa mtendo itakuwa tarehe sita, jana itakuwa tarehe;

- A. mbili
- B. kumi na mbili
- C. tisa
- D. tatu

24. Kisawe cha neno, 'daawa' ni,

- A. madaraka
- B. dhima
- C. kesi
- D. vidonge.

25. Chagua sentensi inayoonyesha kiambishi 'ki' cha udogo.

- A. Akiimba vizuri atatuzwa.
- B. Kitanda kitatengenezwa na seremala.
- C. Kijibwa changu kinabweka.
- D. Mchezaji amelifunga bao lake kimchezo.

26. Ni sentensi ipi yenye *nomino*, *kitenzi* na *kivumishi* ?

- A. Mtoto mdogo anakimbia.
- B. Ndizi zimeiva polepole.
- C. Bata atataga kesho asubuhi.
- D. Mwalimu amechoka.

27. Chagua usemi halisi wa kauli ifuatayo; *Ungentialika ningekuja harusini wakati huo.*

- A. Alisema, "ukinialika ningekuja harusini wakati hule."
- B. Alisema, "ungentialika ningekuja harusini wakati huo."
- C. Alisema, "Nitakuja harusini ukinialika leo."
- D. "Ukinialika nitakuja harusini wakati huu." Alisema.

28. Maneno yafuatayo yatapangwaje katika Kamusi ya Kiswahili?

- (i) mchuzi (ii) mjusti
(iii) mjuzi (iv) mchuuzi
A. i, ii, iii, iv
B. i, iv, ii, iii
C. iv, i, ii, iii
D. ii, i, iii

29. Nyaguthii alisimama akielekea kaskazini, mkono wake wa kulia utakuwa upande gani?
A. Kusini.

- B. Kaskazini.
C. Magharibi.
D. Mashariki.

30. "Za" imetumikaje katika sentensi Hasira za mkizi furaha kwa mvuvi.
A. Kuonyesha hali.
B. Kuonyesha matumizi.
C. Kuonyesha kumiliki.
D. Kuonyesha namna.

Soma kifungu kifuatacho kisha ujibu maswali 31 mpaka 40.

Nilimwalia Musa akicheza kandanda na ndugu zake kwenye kiwanja kilichokuwa mkabala wa nyumba yangu. Niliwatazama kwa mapenzi ya mzazi. Kule kuwapiga wenzake chenga na ustadi wa kufunga mabao wa vijana, kulindiridhisha kwa malezi ya miaka mingi. Ninapomtazama Musa akiwa kiranja kwa wenzake, kumbukizi za kukutana kwetu na hatimaye maisha yetu ya machungu na matamu hunijia.

Alfajiri hiyo nilishuka matwana na kushika ujia ulioelekea shule nilikofunza. Vidibwi vilivyosababishwa na gharika ya usiku kucha vilienea kotekote na kuwazua wapita njia raha ya safari zao. Hata hivyo, mazoea yangu ya miaka mingi katika ujia huu yaliona hali hii kuwa si chochote si lolote. Kwa hivyo nyayo zangu hazikukosa pa kukanyaga. Wasafiri wenzangu walipokuwa wakilalamikia vilima na vibonde kwenye kibarabara hiki, nilikimya tu kwa kuwa nilijua kuwa malalamishi yao yalikuwa kama mikoromo ya vyura kwa viongozi wa kaunti hii. Nilipokaribia kwenye choo kilichokuwa kimejaa mpaka nje, nilisikia kilio cha mtoto mchanga.

Harufu ya choo hicho iliniacha nikishika pua. Nilitembea kwa hadhari kuelekea kilikotokea kilio hicho. Niliwaza na kuwazua. Nilijiuliza, "itakuaje sauti ya mtoto na hiki ni choo?" sikupuuza kwani ilikuwa ibada kuvipata vijusi na njiti wameachwa kiholela katika mji huu. Sauti ile ya kitoto ilizidi na kuzidi, ikanivuta kukaribia choo hicho.

Nilipigwa na butwaa kuona kitoto kimetupwa juu ya kinyesi cha binadamu kikiwa na sauti ya Mungu. Machozi yalinindondoka! Mandhari yale yalinighasi. Nilikichukua kitoto hicho nikakifisha koti langu na kuenda kwenye kituo cha polisi kupiga ripoti. Baada ya kuwaeleza askari yaliyojiri, walitikisa vichwa vyao bila kuonyesha hisia zozote. Nilishangaa zaidi japo huo haukuwa mwisho wa mshangao wangu. Mwishowe nilifahamishwa niondoke kituoni na mtoto huyo niishi naye hadi uchunguzi utakapomalizika.

Miezi sita ilipokamilika, nilifahamishwa kuwa asili ya kitoto changu haijulikani. Nikawa Mlezi wa Musa. Uzazi wangu kwa Musa ulihalalishwa baada ya mamlaka ya idara ya watoto kumruhusu Musa awe mwanangu wa kupanga. Malezi yake yaliendelea nyumbani pangu. Maisha yake na ya watoto wangu yalifana kwani wote walimpenda.

Watoto wangu walichangamkia malezi ya Musa, wote wakafanana, nikampeleka kwenye shule moja na ndugu zake. Akaibukia kuwa mwana wa kutegemewa na mwenye bidii. Akawa kidedea masomoni na akaazimia kusoma hadi chuo kikuu kama ndugu zake. Nimwonapo mimi bado hushangaa sababu ya mama yake kumtelekeza. Kijana huyu ni fahari yangu. Kila mtoto ana haki zake.

31. Kulingana na aya ya kwanza,
 A. msimulizi ametosheka na namna alivyowalea wana wake
 B. watoto walikuwa wakicheza kandanda pembeni mwa nyumba.
 C. mzazi hakuwa na wasiwasi kutokana na mchezo wa watoto wake
 D. mzazi aliajambia ushujaa wa wana wake wa kucheza kandanda.
32. Kifungu hiki kimedhihirisha kuwa,
 A. malezi ya Musa yalifanya mama kuwazia maisha yake ya baadaye
 B. mchezo waliocheza wana ulimfanya mama kuzingatia ulezi uliopita
 C. mama na Musa walipata raha na shida
 D. Musa aliwashinda wenzake mchezoni.
33. "Nilijua kuwa malalamishi yao yalikuwa kama mikoromo ya vyura kwa viongozi wa kaunti hii." ina maana kuwa;
 A. viongozi walizidisha vitendo vya kuharibu barabara na kupuuza kashfa za watu
 B. viongozi walipenda mikoromo ya vyura
 C. viongozi walizidisha madhara ya mvua na kupuuza maoni ya watu
 D. wakazi walilaumiana huku hali mbaya ya barabara ikizidi.
34. Ni kweli kuwa,
 A. barabara imekuwa na vidimbwi vya maji kwa miaka mingi
 B. msimulizi alishaepuka madhara ya mvua
 C. msimulizi hakupata taabu kama wapita njia wengine
 D. kuwepo kwa mvua kila mahali kulihuzunisha wapita njia.
35. Chagua jawabu sahihi kulingana na aya ya nne,
 A. msimulizi alikuwa amebeba koti la mtoto
 B. msimulizi alikuwa na huruma kwa kitoto
 C. askari hawakumshughulikia msimulizi kituoni.
 D. msimulizi alitaka aishi na mtoto uchunguzi ukiendelea.
36. Kwa nini askari kituoni hawakuonyesha hisia zozote kituoni kwa mtoto huyo?
 A. Uchunguzi haukuwa umekamilika.
 B. Mtoto alikuwa tayari ashapata mlezi.
 C. Walizoea visa vya aina hii kituoni.
 D. Hawangeweza kupata mzazi wa mtoto kwa njia rahisi.
37. Ni haki zipi za watoto zilizokiukwa kwenye kifungu hiki?
 A. Malezi na uhai.
 B. Usafi na mavazi.
 C. Elimu na uhai.
 D. Uhai na makao.
38. Kulingana na aya ya mwisho, Musa,
 A. alifanikiwa masomoni kama ndugu zake
 B. alisoma chuo kikuu kama ndugu zake
 C. alitimiza malengo yake kama ndugu zake
 D. alitarajia kusoma hadi chuo kikuu kama ndugu zake.
39. Uzazi wa mama ulihalalishwa kwa kuwa,
 A. watoto wake walimpenda Musa
 B. alilazimishwa kuwa mzazi wa Musa
 C. wazazi wa Musa hawakujulikana
 D. malezi ya mama yalikuwa mazuri.
40. Ni mshangao gani ambao msimulizi anasema haukuwa mwisho?
 A. Kupata kitoto kwenye choo.
 B. Askari kutoonyesha hisia zozote kwa kitoto.
 C. Kuagizwa kuondoka kituoni na mtoto.
 D. Kuwapa watoto wake malezi bora.

Soma kifungu kifuatacho kisha ujibu maswali 41 mpaka 50.

Ukuaji wa uchumi wa nchi unategemea juhudi za kila mzalendo. Hata hivyo, ni jambo la kuvunja moyo kuona baadhi yetu tusiojali tukitwika wengine jukumu hili pamoja na serikali yetu. Watu wasiojali huiachia serikali mzigo wa kuendesha gurudumu zito la maendeleo ya nchi. Hawajiulizi, je nimeifanyia serikali yangu nini?

Serikali pamoja na wananchi ni kama petroli inayohakikisha nchi inasonga mbele kiuchumi. Kila mtu afahamu kuwa bidii ya kichuguu ndiyo itakayotuondoa kwenye lindi la umaskini. Hebu wazia wadudu wadogo kama nyuki. Kutokana na bidii yao hujitengenezea asili yao wenyewe na kurwalisha wanadamu. Iwapo chungu au nyuki wanaweza kupata maendeleo makubwa kwa yale wafanyayo. seuze binadamu?

Kila mmoja wetu amejaliwa talanta na Mola. Kwa nini hatuwezi kuzitumia kuinua uchumi wa nchi? Umoja wetu unaweza kusuluhisha matatizo mengi yanayotukumba. Tujue wazi kuwa jifya moja haliinjiki chungu. Watu wanaofanya kazi mbalimbali lazima waziimarisha ili kuinua uchumi wa nchi na kubadilisha maisha yao. Hasa wakulima watumie teknolojia ya kisasa kuzalisha mazao anuwai. Wakitekeleza haya, baa la njaa linalowaathiri wengi litazikwa katika kaburi la sahu.

Vijulanga nao wana jukumu lao kwa nchi yetu. Wale wasomao shuleni wanaweza kuchangia uchumi wa nchi kwa kujihusisha kwa kina shughuli zote za shuleni. Wafanye bidii vilivyo. Si masomoni, si michezoni, si kuauni jamii katika miradi mbalimbali. Wakishiriki katika shughuli za kusafisha miji yetu, watakuwa wakiukumbatia wito wa serikali wa kuhifadhi mazingira.

Maeneo yaliyo nje ya miji yanahitaji kushughulikiwa kimaendeleo pia. Mbali na ukweli kuwa sehemu nyingi zina rutuba, wengi huguria mijini kutafuta kazi zenye hela.

Huwaachia wakongwe mashamba na matokeo yake ni mazao haba. Iwapo Wakenya wanataka kusaidiwa kustawisha na kuinua hali zao za maisha, ni lazima sisi wenyewe tuwe tayari kuwajibikia hali zetu kwani abebwaye hujishikiza. Umoja kwa nchi yetu ni muhimu. Tuungane tujenge uchumi wetu.

41. Ukuaji wa uchumi wa nchi unahitaji,
 A. serikali kufanya kila jambo
 B. watu wengine kupewa jukumu kuinua uchumi
 C. kutohamia mijini kutafuta kazi
 D. ushirikiano wa serikali na kila mwananchi.
42. Watu wanaojali ni wale,
 A. wanaotekeleza wajibu wao kuendeleza uchumi
 B. wanaojiuliza maswali mengi kuhusu uchumi
 C. wanaotarajia kusaidiwa na serikali
 D. wanaoachia wengine jukumu la kuimarisha uchumi.
43. Kifungu kimelinganisha binadamu na chungu au nyuki kwa kuwa,
 A. bidii yao huwafaidi wao wenyewe
 B. nyuki na chungu huwa na umoja
 C. bidii yao na umoja wao huwafaidi wao na wengine
 D. wadudu hao wote huwa na bidii za kujenga
44. Wananchi na serikali ni kama petroli kwa sababu,
 A. bila petroli uchumi utadidimia
 B. ukuaji wa uchumi unawategemea
 C. bila serikali uchumi hautaimarika
 D. vijana wakibaki mashambani uchumi hautaimarika.
45. Kwa mujibu wa kifungu, mambo yanayodhihirisha ukweli wa methali, "iifya moja haliinjiki chungu" ni
 A. vijana kuhamia mijini kuwaacha wakongwe mashambani
 B. vijana kuwajibika masomoni, kimichezo na katika miradi ya kijamii
 C. umoja wa nyuki na wananchi na serikali kujitahidi pamoja
 D. serikali kung'ang'ana peke yake kuimarisha uchumi wetu.
46. Kulingana na kifungu, maana ya kazi zenye hela ni,
 A. kazi zilizo bora kuliko za mashambani
 B. kazi ambazo hazihitaji nguvu nyingi
 C. kazi za wenye elimu ya hali ya juu
 D. kazi zinazofikiriwa kuwa na mishahara mikubwa.
47. Abebwaye hujishikiza. ina maana kuwa;
 A. anayesaidiwa hana budi pia kujitahidi
 B. anayebebwa lazima ashikilie ambebaye
 C. tusitarajie msaada wa yeyote ikiwa sisi pia hatusaidii
 D. tunapowasaidia wengine sharti tujitahidi.
48. Ni kweli kuwa vijana wanastahili,
 A. kusoma na kubaki mashambani
 B. kushiriki kilimo ili wajiimarisha
 C. kufanya kazi mbalimbali kuimarisha uchumi wa nchi
 D. kutumia teknolojia ya kisasa kuongeza mazao.
49. Iwapo chungu au nyuki wanaweza kupata maendeleo makubwa kwa yale wafanyayo, seuze binadamu? Maana yake ni,
 A. nyuki na chungu huwa na maendeleo makubwa
 B. binadamu wana uwezo wa maendeleo makubwa zaidi
 C. nyuki na chungu hufanya maendeleo makubwa kuliko binadamu
 D. binadamu ana bidii na umoja wa kutenda kazi.
50. Funzo tunalopata kutokana na kifungu hiki ni,
 A. ushirikiano na bidii ya kila mmoja huleta maendeleo
 B. tukiwa na bidii bila ushirikiano tutapata maendeleo
 C. serikali ina jukumu la kuleta maendeleo nchini
 D. vijana ndio wanaofaa kufanya kazi zaidi kuinua uchumi.

1121214000

SOCIAL STUDIES AND RELIGIOUS EDUCATION

STANDARD EIGHT - 2015

INSTRUCTIONS TO CANDIDATES (please read these instructions carefully.)

1. You have been given this question booklet and a separate answer sheet. The question booklet contains 90 questions.
2. Do any necessary rough work in this booklet.
3. When you have chosen your answer, mark it on the **ANSWER SHEET**, not in the question paper.

HOW TO USE THE ANSWER SHEET.

4. Use an ordinary pencil only.
5. Make sure that you have written on the answer sheet:-

YOUR INDEX NUMBER

YOUR NAME

NAME OF YOUR SCHOOL

6. By drawing a **dark line** inside the correct numbered boxes, mark your full Index Number (i.e. School Code Number and the three-figure Candidate's Number) in the grid near the top of the answer sheet.
7. Do not make any marks outside the boxes.
8. Keep your answer sheet as clean as possible and **do not fold it**.
9. For each of the questions 1-90, four answers are given. The answers are lettered A, B, C, D. In each case, only **ONE** of the four answers is correct. Choose the correct answer.
10. On the answer sheet, show the correct answer by drawing a **dark line** inside the box in which the letter you have chosen is written.

Example:-

In the Question Booklet:

32. One reason why young people are being encouraged to marry when they mature is.
A. to acquire wealth quickly
B. to be able to manage their families properly
C. to get few healthy children
D. to enable them get marriage certificate

The correct answer is B.

On the Answer sheet:

31. [A] [B] [C] [D] 32. [A] [B] [C] [D] 33. [A] [B] [C] [D] 34. [A] [B] [C] [D]

In the set of boxes number 32, the box with letter **B** printed in it is marked.

11. Your dark line **MUST BE** within the box.
12. For each question, **ONLY ONE** box is to be marked in each set of four boxes.

This question paper consists of 12 printed pages.

PART I: SOCIAL STUDIES

GONI AREA

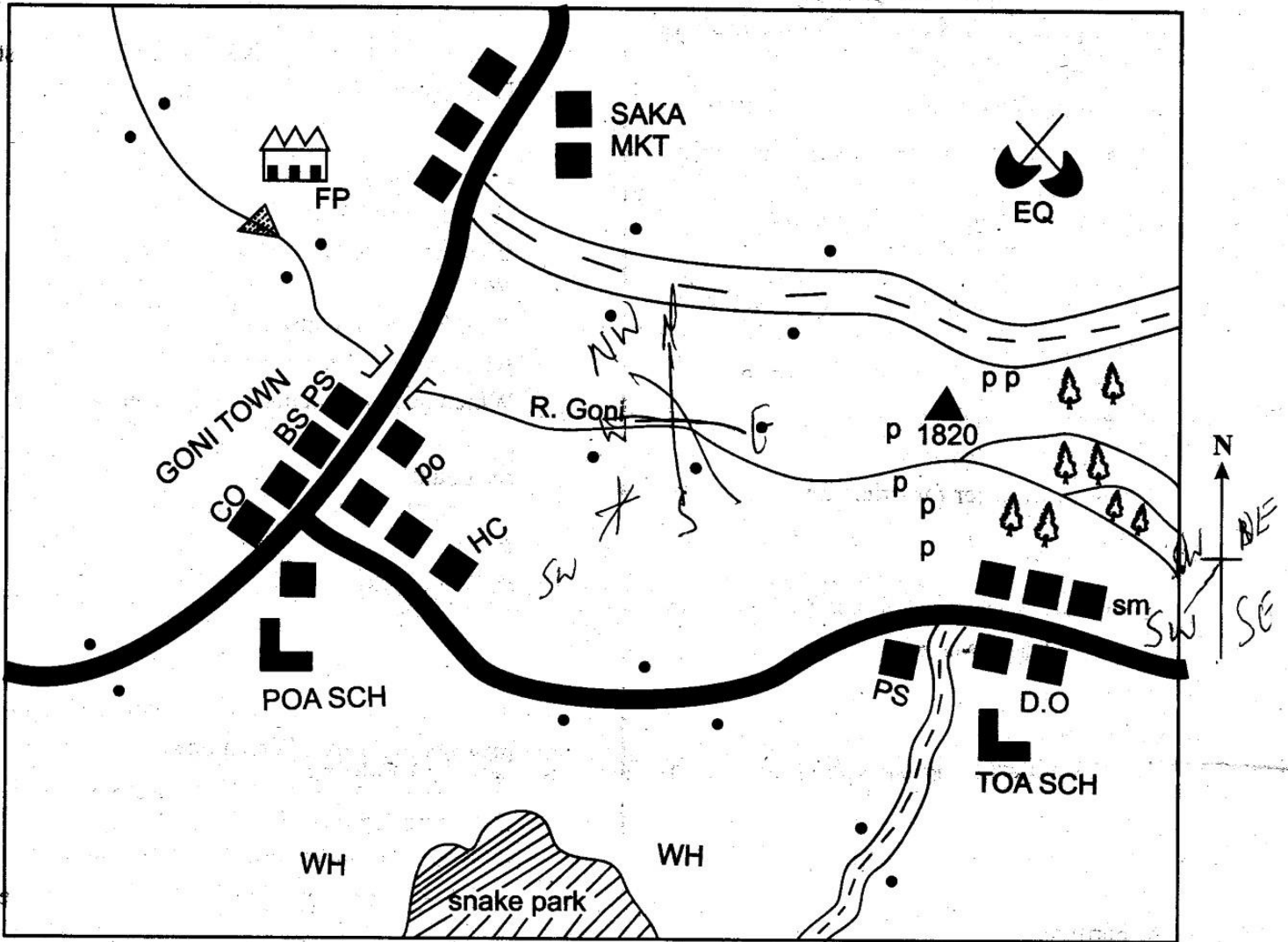

SCALE

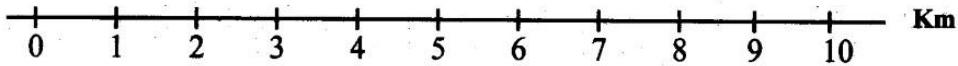

KEY:

Tarmac road	CO - County offices HC - Health Centre	A bridge and a river	EQ - Exhausted mine
Murram road	SM - Saw mill ppp - Pyrethrum	BS - Bible School	D.O - District Officer
Forests	Build up areas	PO - Post Office	FP - Fishing plant
A dam	• • • Settlement	PS - Police Station	WH - water holes

Study the map of Goni Area and answer Questions 1 to 7.

1. Which one of the following correctly describes the distribution of population in Goni area?
 - A. The population is evenly distributed along the road.
 - B. Most people live in the market centres.
 - C. The population is evenly distributed in the area.
 - D. People are organised into villages.
2. Which one of the following would be the best function of the dam shown in the map?
 - A. Trap water for production of H.E.P.
 - B. Centre for inland drainage.
 - C. Centre of tourist attraction.
 - D. Source of water for irrigation.
3. The climate to the South western part of the area is
 - A. Hot and wet
 - B. Hot and dry
 - C. Cool and wet
 - D. Cool and dry.
4. The main economic activity to the southern area is
 - A. Farming
 - B. Trading
 - C. Saw milling
 - D. Tourism.
5. The general rise of river Goni is
 - A. North to South
 - B. South East to North West
 - C. North West to South East
 - D. South to North.
6. The senior most administrator in Goni area is a _____.
 - A. District officer
 - B. Police officer
 - C. Governor
 - D. District commissioner

7. Three of the following statements about Goni area are true. Which one is false
 - A. Mining is one of the economic activities in the area.
 - B. Tourists makes occasional visits in the region
 - C. Land in Goni area rises towards South East
 - D. Most shops sell insecticides.
8. Below are uses of forests
 - (i) They provide fuel
 - (ii) They make landscape beautiful
 - (iii) They control soil erosion
 - (iv) They are habitat for wildlife
 - (v) They are water catchment areasWhich group explains why the Kenyan government is encouraging tree planting in the country?
 - A. (i), (ii), (iv)
 - B. (ii), (iii), (v)
 - C. (i), (ii), (iii)
 - D. (ii), (iv), (v)
9. The following are economic benefits of river projects in Africa. Which one is not?
 - A. Increased food and cash crop production
 - B. Controlled river floods downstream
 - C. Power production for industrial growth
 - D. Increased fish production in the man made lake.
10. The clove plants are grown in the same farms with coconut plants in Tanzania because;
 - A. They improve soil fertility.
 - B. They help improve the quality of cloves
 - C. Land is not adequate for growing the two crops separately
 - D. They protect the clove plants from wind.
11. There are many ways of acquiring population data. Which one is not a source of population data
 - A. Population census
 - B. Registration of births
 - C. Church baptism records
 - D. Registration of deaths.

12. Which combinations show major imports in Kenya?
- A. Petroleum, machinery, fertilizer
 - B. Foodstuff, medical drugs, sisal
 - C. Coffee, tea, pyrethrum
 - D. Flourspar, soda ash, limestone

13. One major problem facing urban centres in most African countries is
- A. African culture is undermined
 - B. Pollution from industries
 - C. Poor disposal of rubbish
 - D. Congestion caused by rural to urban migration.

14. Identify the two rivers that supply water to the Mwea Tembere Irrigation Scheme.
- A. Perkerra and Molo
 - B. Nyando and Nzoia
 - C. Nyamindi and Thiba
 - D. Thiba and Sio.

15. A common similarity between Daniel Arap Moi and Oginga Odinga is that both
- A. Resigned from political offices
 - B. Retired voluntarily from political seats
 - C. Introduced multi party democracy in Kenya
 - D. Were vice presidents in Kenya.

16. Which one of the following is done by a Kenyan citizen after reaching 18 years of age. He/She
- A. Acquires free primary education
 - B. Acquires citizenship of another country
 - C. Can start a family
 - D. Can be voted to become a president.

Use the map to answer questions 17 to 21.

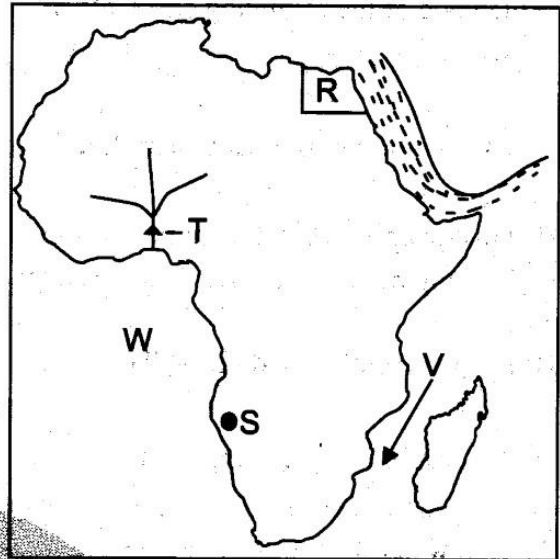

17. The country marked R was colonised by
- A. French
 - B. Germany
 - C. British
 - D. Portuguese.

18. The plateau marked S is called _____
- A. Fouta Djallon
 - B. Adamawa
 - C. Jos plateau
 - D. Bie plateau.

19. The man made lake formed at the place marked T is called
- A. Akosombo dam
 - B. L. Volta
 - C. L. Kariba
 - D. L. Nasser.

20. Identify the ocean current marked V
- A. Agulhas ocean current
 - B. Benguela ocean current
 - C. Somali ocean current
 - D. Canary ocean current.

21. The two Island countries found in the water mass marked **W** are?
- Cape verde and Mauritius.
 - Seychelles and Comoros.
 - Madagascar and Cape verde.
 - Sao Tome and Cape verde.
22. In Kenya, most of the fish caught comes from
- The Indian ocean
 - The inland fishing grounds
 - Lake Victoria and L. Bogoria
 - Along major rivers.
23. One **major** problems facing most irrigation schemes in Kenya is
- Shortage of water during dry season
 - Lack of market for their produce
 - Lack of labour in the farms
 - Frequent flooding that lowers production
24. The following are reasons why people in Kenya should vote in national elections, which one is **not**?
- To obey the laws of the country.
 - To elect a new government.
 - To elect the leaders of their choice.
 - To exercise their democratic rights.
25. The following statements are problems facing maize growing in Kenya. Which one is **not**?
- The maize plants are attacked by pests.
 - Importance of cheap maize.
 - lack of sufficient rainfall.
 - Lack of market for maize.
26. Chief Iwanika befriended the British **mainly** because
- He wanted to benefit from the British
 - He wanted protection against his enemies
 - He wanted to expand his territory
 - He wanted to receive western education.
27. Which one of the following factors has contributed most to the fast growth of **Malindi** town?
- Rich agricultural land in the area.
 - Increased tourist activities in the area.
 - Establishment of industries in the region.
 - Presence of adequate security in the area.
28. A woman who divorces in a court of law with her husband is entitled to;
- A share of the family property
 - Marry another man of her choice
 - Share the children with the husband
 - Go with the children.
29. The **main** role of parents in a public primary school is;
- Instil discipline in pupils
 - Choose the school committee
 - Implement development projects
 - Choose the head teachers.
30. Three of the following places are pre-historical sites in Eastern Africa. Which one is **not**?
- Hyrax hill in Kenya.
 - Magosi in Uganda.
 - Fort Jesus in Kenya.
 - Isimila in Tanzania.
31. The population of Germany **mainly** consists of
- People who are above 50 years of age
 - People who live in the rural areas
 - People involved in agricultural activities
 - People who have large families.

32. Which one of the following is a form of child abuse?

- A. Herding the family livestock.
- B. Withdrawing children from school.
- C. Digging the family farm.
- D. Forcing children to go to school.

33. Which one of the following statements about perkerra irrigation scheme is true?

- A. Crops are grown throughout the year.
- B. Crops are grown in large plantations.
- C. Tractors are used to prepare the land.
- D. Harvesting is done by machines.

34. Three of the following are functions of the cabinet except

- A. Discussing matters of national importance
- B. Discussing government policies
- C. Passing government policies
- D. Advising the president on legal matters.

35. Marine fishing in Kenya is faced with the problem of

- A. old and outdated fishing equipment
- B. presence of few fish in Kenya waters
- C. lack of adequate market
- D. presence of foreign fishing vessels in Kenyan water.

36. Which one of the following statements about indigenous forests in Kenya is true?

- A. They consists of planted trees.
- B. They provide raw materials for pulp industry.
- C. They consists of trees of the same type.
- D. Trees are made up of different species.

Use the diagram to answer questions 37 and 38.

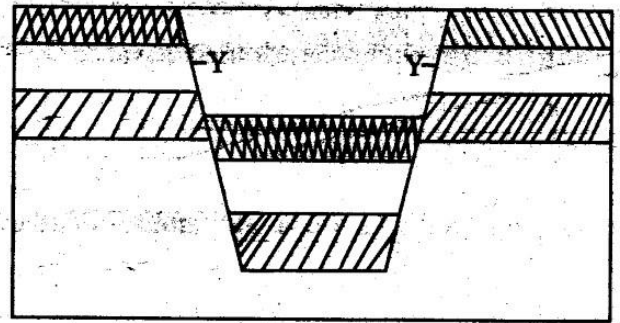

37. The lines of weakness marked Y are called

- A. Faults
- B. Ranges
- C. Escarpment
- D. Dykes.

38. Three of the following lakes found in the above feature except

- A. L. Kivu
- B. L. Turkana
- C. L. Natron
- D. L. Albert.

39. Africans lost the Mau Mau war in the 1950 mainly because;

- A. British soldiers were better equipped
- B. African fighters were few
- C. Many Africans did not support the war
- D. The dense forests did not favour the Africans.

40. Citizens should not practice corruption mainly because

- A. It promotes equality
- B. It promotes national unity
- C. It encourages patriotism
- D. It stagnates development.

41. Which one of the following events promotes the different cultures of the Kenyan communities?

- A. Admission of pupils to national schools.
- B. Schools music festivals.
- C. Registration of all births.
- D. Free primary education.

42. How do county authorities regulate the conduct of people within their areas of jurisdiction?

- A. Through by laws.
- B. Through the police.
- C. Through the chief.
- D. Through laws county parliament proposes.

43. Three of the following are true about forming a government. Which one is **not**?

- A. The president appoints the cabinet.
- B. The president elect is sworn in.
- C. All government officials are appointed.
- D. The president appoints senior officials of government.

44. What type of democracy is practised in the present system of government of Kenya?

- A. Indirect democracy.
- B. Consensual democracy.
- C. Direct democracy.
- D. Delegative democracy.

45. Which one of the following statements is **true** about small scale farming in Netherlands?

- A. Farmers grow mainly maize.
- B. All the crops are consumed locally.
- C. Farmers keep cattle.
- D. Most crops grown are for urban market.

46. Which one of the following statements about an arrested person by the police is **correct**

- A. He is allowed to see a lawyer
- B. He is detained without trial

- C. He is taken to prison.
- D. He is caned and released.

47. Which one of the following is an abuse of human rights by the Kenya police?

- A. Arresting drivers of overloaded vehicles.
- B. Forcing a suspect to tell the truth.
- C. Locking up a suspect in a police cell.
- D. Arresting people taking alcohol outside drinking house.

48. Where is an amendment bill drafted before it is presented to parliament?

- A. The high court.
- B. Office of the president.
- C. Court of Appeal.
- D. In Attorney General's chambers.

49. The **main** cause of rural to rural migration in Kenya is

- A. lack of water
- B. search for employment
- C. search for land for settlement
- D. outbreak of diseases.

50. The highest subordinate court in Kenya is

- A. Supreme court
- B. Chief Principal magistrate court
- C. High court
- D. Resident court.

Use the diagram to answer questions 51 and 52

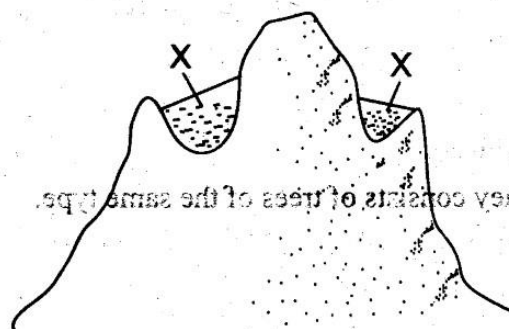

51. The lake marked x are examples of

- A. Lava dammed lake
- B. Crater lakes

- C. Corrie lakes
- D. Faulty lakes.

52. The above lake has been formed through a process called

- A. Glaciation
- B. Faulting and sinking
- C. Deposition
- D. Down warping

53. Which one of the following events in Kenya took place second?

- A. Formation of KADU.
- B. Ending of the state of emergency.
- C. Release of Jomo Kenyatta from detention.
- D. Appointment of the first African to legco.

54. Below are traditional industries carried out by Kenyan communities. Which one was learnt through apprenticeship?

- A. Iron working.
- B. Weaving.
- C. Pottery.
- D. Hunting.

55. The Jua kali industry in Kenya is important because it;

- A. Enables people to export products
- B. Enables people to keep the environment clean
- C. It controls rural to urban migration
- D. Enables people to use locally available raw materials.

56. Three of the following are uses of copper except?

- A. Making coins.
- B. Making ornaments.
- C. Drilling other metals.
- D. Making electronics.

57. Pupils can help manage the school in the following ways **except**

- A. Reading for the exams
- B. Obeying the school rules
- C. Respecting the teachers
- D. Respecting the school prefects.

58. The **main** natural problem facing people who live along the banks of R. Nzoia in Kenya is

- A. Water borne diseases
- B. Flooding
- C. Siltation
- D. Siltation.

59. *(i) No marriage certificate is given*
(ii) Conducted by a magistrate
(iii) Rites are performed
(iv) There is exchange of vows
Which statement describes a customary marriage

- A. (i), (iii)
- B. (i), (iv)
- C. (ii), (iv)
- D. (iii), (iv)

60. The political party that led Ghana to independence was called;

- A. United Gold coast convention (UGCC).
- B. The National Liberation movement.
- C. The Northern People's party.
- D. Conventional people's party (CPP).

74. "Happy are the peacemakers, for they
A. shall see God
B. Shall be called sons of God
C. Shall inherit the earth
D. Shall receive what God has promised
75. People of Nazareth rejected Jesus and his teaching because;
A. Jesus had healed people in the sabbath
B. Jesus used Belzebug power
C. Jesus had refused to perform miracles
D. They did not like Jesus interpretation of the scriptures
76. Which one of the following activities did not take place at the last supper
A. Judas Iscariot shared the meal
B. Jesus talked about his second coming
C. Peter denied Jesus three times
D. Jesus washed his disciples
77. The disciples whom Jesus met after his resurrection were from?
A. Emmau.
B. Jericho.
C. Nazareth.
D. Jerusalem.
78. Who among the following people did Peter raise back to life at Joppa?
A. Aquilla
B. Aeneas
C. Lazarus
D. Tabitha
79. Three of the following are gifts of the Holy spirit. Which one is **not**?
A. Working miracles.
B. Visiting the sick.
C. Speaking the word.
D. Interpreting dreams.
80. Who among the following secret disciples donated his tomb for Jesus to be buried?
A. Joseph of Arimathea
B. Nicodemus.
C. Simon of Cyrene
D. Timothy
81. In traditional African communities, the initiates were united to their ancestors through
A. Circumcision
B. Libation
C. Shedding blood
D. Baptism
82. New born babies were not shown to stranger because;
A. Mothers fear they might be stolen
B. Some mothers fail to wash them properly
C. They start crying when they see strangers
D. They are being protected from people with evil eyes
83. One of the following belief is common to both traditional African religion and Christianity. Both;
A. Belief in life after death
B. Belief in the resurrection
C. Belief in witchcraft
D. Beliefs in angels
84. Your friend Brandon doesn't want to share his lunch with his deskmate. What should you do?
A. Report him to the classteacher
B. Share your lunch with his desk mate
C. Tell him the importance of sharing
D. Tell his deskmate to change his sitting position.
85. Mogire saw Oyatsi wearing a new pair of uniform and started wishing that they were hers. Oyatsi should tell her
A. Do not steal
B. Do not covet
C. Do not accuse anyone falsely
D. You shall not commit murder
86. When employing people in an office, a Christian should;
A. Consider his relatives
B. Not consider his relatives at all
C. Show partiality in selections
D. Be impartial in selection

87. Churches should be involved in community development projects **mainly** because;
- It improves the quality of life
 - To promote the local culture
 - To win more converts for christ
 - To provide employment to the youth.
88. Which one of the following is the **best** way for Christians to use their wealth?
- Entertaining friends.
 - Helping the needy.
 - Visiting places.
 - Calling on Gods name.
89. In 2 Timothy 3:16, All scriptures is **inspired** by God. This means;
- God wrote the whole Bible
 - The Bible was written by an angel
 - The word of God was written in heaven
 - God inspired the writers of the Bible
90. Believers were first called Christians at
- Jerusalem
 - Behlehem
 - Antioch
 - Nazareth.

SECTION II

ISLAMIC RELIGIOUS EDUCATION

61. "Did we not find you poor and made you rich" This quotation comes from surah,
- Dhuha
 - Inshirah
 - Maun
 - Tiin.
62. Surah Al-ikhlas empasizes on,
- Importance of prayers.
 - Importance of knowledge.
 - Oneness of Allah.
 - The day of judgement.
63. An important event that took place during the night of power is,
- the birth of prophet mohammad
 - the revelation of Quran
 - the journey of Isra-wal-miraj
 - the migration of muslims to madina.

64. Surah Al-kauthar warns,
- non muslims
 - the friends of the prophets
 - adulterers
 - the enemies of the prophet.
65. Which surah of the Quran promises victory and success to prophet mohammad (S.A.W)?
- Nasr.
 - Falaq.
 - Fiil.
 - Takathur.
66. After completing a task, a muslim should always say,
- Subhanallah
 - Al-hamdulillah
 - Bismillah
 - Astaghfirullah.
67. The prophet (SAW) said that we should always say the truth even through it is,
- bad
 - good
 - sweet
 - bitter
68. According to the prophet (SAW) what will **mostly** take people to paradise is the fear of Allah and,
- taqwa
 - obedience
 - behaving well towards people
 - reading the quran.
69. Which of the following faradh salat has two rakaat?
- Dhuhr.
 - Asr.
 - Maghrib.
 - Subh.
70. The eighth month of the Islamic calendar is,
- Muharram
 - Shaban
 - Ramadhan
 - Rabiul - Awwal.
71. How many months are there on the Islamic calendar?
- | | |
|------------|------------|
| A. Ten. | B. Seven. |
| C. Eleven. | D. Twelve. |

72. How many miqaat were appointed by prophet mohammad (SAW) before his death?
 A. Three. B. Two.
 C. Five. D. Four.
73. Which month of the Islamic calendar is known as the month of Allah (SW)?
 A. Muharram. B. Dhul-hijjah.
 C. Shawwal. D. Rajab.
74. The act of relying on Allah (SW) is known as,
 A. Taqwa B. Tawwakul
 C. Ihsan D. Iman.
75. The fourth pillar of Islam is,
 A. Hajj B. Zakat
 C. Shahada D. Saum.
76. The prophet of Allah (SW) who was given the scrolls was
 A. Ibrahim
 B. Mohammad
 C. Musa
 D. Isa
77. Which type of Najasaat is washed seven times,
 A. light B. heavy
 C. medium D. strong.
78. The act of mixing good and bad quality goods is known as,
 A. ghush B. hoarding
 C. usury D. profit.
79. The best action for you to take when you find your friends fighting is,
 A. report them to the team
 B. leave them alone
 C. help the weaker one
 D. separate them.
80. Which of the following activities does not take place during Aqiqah?
 A. Naming.
 B. Slaughtering.
 C. Circumcision.
 D. Adhan.
81. Which one of the following acts is the most important during the day of Idd-ul-hajj?
 A. Praying two rakaat.
 B. Visiting friends.
 C. Slaughtering an animal.
 D. Giving sadaqa.
82. When we visit a sick person we should,
 A. stay for a short time
 B. take the flowers
 C. stay for along time
 D. eat their food.
83. The holy Quran was revealed during the month of,
 A. Muharram
 B. Ramadhan
 C. Shaban
 D. Dhul-Qaadah.
84. The swahaba of the prophet (SAW) that was tortured with a huge stone on his chest is known as,
 A. Musab B. Talha
 C. Bilaal D. Yasir.
85. The third battle to be fought in the history of Islam was,
 A. Khandaq B. Hunain
 C. Badr D. Uhud.
86. The third rightly guided caliph of Islam was,
 A. Ali B. Abubakar
 C. Umar D. Uthman.
87. On hearing good news, a muslim should,
 A. scream
 B. cry with joy
 C. perform sijdatul-shukr
 D. jump up and down.
88. The believe in the prophets of Allah is the _____ pillar of Iman.
 A. fourth B. third
 C. second D. first
89. Who of the following prophets made a bird from clay?
 A. Ibrahim. B. Isa.
 C. Mohammad. D. Musa.
90. The prophet's mosque is found in,
 A. Madina B. Makkah
 C. Egypt D. Taif.

MATHEMATICS

STANDARD EIGHT - 2015

INSTRUCTIONS TO CANDIDATES (Please read these instructions carefully).

1. You have been given this question booklet and a separate answer sheet. The question booklet contains 50 questions.
2. Do any necessary rough work in this booklet.
3. When you have chosen your answer, mark it on the ANSWER SHEET, not in the question booklet.

HOW TO USE THE ANSWER SHEET

4. Use an ordinary pencil.
5. Make sure that you have written on the answer sheet:

YOUR INDEX NUMBER

YOUR NAME

NAME OF YOUR SCHOOL

6. By drawing a dark line inside the correct numbered boxes, mark your full Index Number (i.e. School Code Number and the three-figure Candidate's Number) in the grid near the top of the answer sheet.
7. Do not make any marks outside the boxes.
8. Keep the sheet as clean as possible and **DO NOT FOLD IT**.
9. For each of the questions 1-50, four answers are given. The answers are lettered A, B, C and D. In each case only **ONE** of the four answers is correct. Choose the correct answer.
10. On the answer sheet, the correct answer is to be shown by drawing a dark line inside the box in which the letter you have chosen is written.

Example

In the Question Booklet:

1. The sum of 3 consecutive odd numbers is 237. Find the largest number among them.
A. 77
B. 75
C. 79
D. 81

The correct answer is D.

On the Answer sheet:

[A] [B] [C] [D] [A] [B] [C] [D] [A] [B] [C] [D] [A] [B] [C] [D]

In the set of boxes number 1, the box with letter D printed in it is marked.

11. Your dark line **MUST BE** within the box.
12. For each question, **ONLY ONE** box is to be marked in each set of four boxes.

This question paper consists of 8 printed pages.

1. What is 54054504 written in words?
- Fifty four million fifty four five hundred and four.
 - Fifty four million five hundred and forty five thousand and four.
 - Five million four hundred and five thousand forty five and four.
 - Fifty four million fifty four thousand five hundred and four.

2. Arrange the following numbers from the smallest to the largest.

313313, 331313, 331133, 333113

- 333113, 331313, 331133, 313313
- 313313, 331313, 331133, 333113
- 313313, 331133, 331313, 333113
- 313313, 333113, 331133, 331313

3. Work out:

$$48 - (6 \times 108 \div 9 - 8) + 37$$

- 21
 - 53
 - 75
 - 28
4. Which digit is in the place value of thousandths after working out 9.374×1.3 ?
- 1
 - 6
 - 2
 - 8

5. The area of a square plot is $33\frac{1}{16} \text{ m}^2$. What is the perimeter of the plot?
- $4\frac{3}{4} \text{ m}$
 - 17m
 - 23m
 - 46m

6. Calculate the area of the shaded part in the figure below.

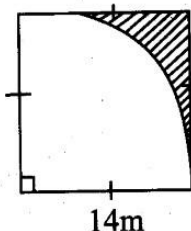

- 42cm^2
- 56cm^2
- 48cm^2
- 52cm^2

7. Work out

$$\left(11\frac{1}{4} - \frac{6\frac{1}{4}}{2} - \frac{1\frac{1}{2}}{3} \right)$$

- $10\frac{11}{12}$
- $3\frac{1}{2}$
- $4\frac{1}{3}$
- $2\frac{7}{12}$

8. A cylindrical container holds 284.75 litres of water. The water was then packed into 0.125 litre containers. How many containers were obtained?
- 3280
 - 1990
 - 1139
 - 2278

9. A pupil scored 60% in a test. If there were 40 questions, how many questions did he get right?
- 30
 - 36
 - 24
 - 16

10. Calculate the area of the figure drawn below.

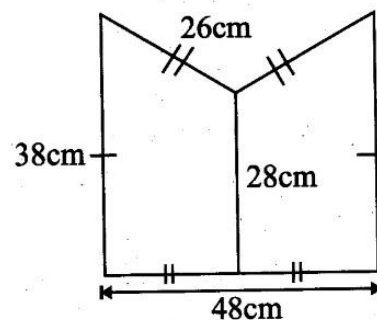

- A. 858cm^2
- B. 1584cm^2
- C. 792cm^2
- D. 1824cm^2

11. Kibe bought the following items from the market;
- 4 cabbages @ sh. 35
 - 2 tins of beans for sh. 105
 - $2\frac{1}{2}$ kg of onions @ sh. 80
 - 3 water melons
- He paid for the items using 2 - sh 500 notes and received a balance of sh. 285, what was the cost of each melon?
- A. sh. 635
 - B. sh. 270
 - C. sh. 335
 - D. sh. 90

12. Calculate the curved surface area of a pipe whose radius is 14cm and a length of 2metres
- A. 176cm^2
 - B. 1760cm^2
 - C. 17600cm^2
 - D. 176m^2

13. The hire purchase price of a TV set is sh. 24 000. It is 20% more than the marked price. The cash price is sh. 1550 less than the marked price. How much more would one pay for buying it at hire purchase price than paying it on cash?
- A. sh. 4000
 - B. sh. 5550
 - C. sh. 1550
 - D. sh. 22 450

14. $\frac{5}{12}$ of the number of people in a church are men. $\frac{1}{4}$ are women. There were equal number of male and female children. If the female children were 48, how many people were there in the church?
- A. 288
 - B. 144
 - C. 360
 - D. 172

15. Convert 8.75% into decimal
- A. 8.75
 - B. 875
 - C. 87500
 - D. 0.0875

16. In the figure below $AB = BC = CD = DA = 25\text{cm}$. Line $AC = 14\text{cm}$. What is the length of line BD ?

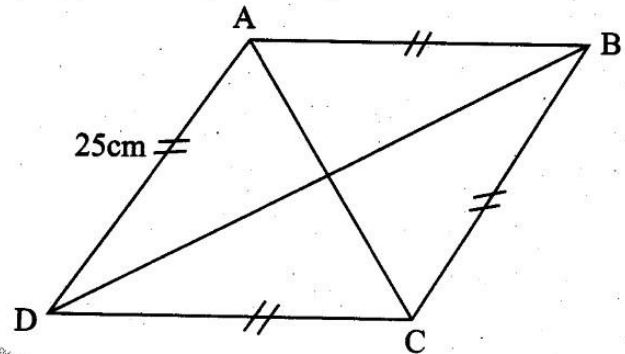

- A. 24cm
 - B. 14cm
 - C. 48cm
 - D. 40cm
17. The area of Kamuiru's primary school compound is square measuring 2.89 hectares. What is the length of two of its sides in metres?
- A. 170
 - B. 340
 - C. 680
 - D. 2400
18. The ratio of Hyenas to Zebras to Lions in a park was 6:9:3 respectively. There were 1080 animals in total at the beginning of the year. By the end of the year both the Hyenas and the Zebras had increased in the ratio 5:3 while the lions increased in the ratio 3:2. How many animals were there by the end of the year in total?
- A. 1550
 - B. 1770
 - C. 1450
 - D. 1525

19. Calculate the surface area of the closed cylinder drawn below. (Take $\pi = 3.14$)

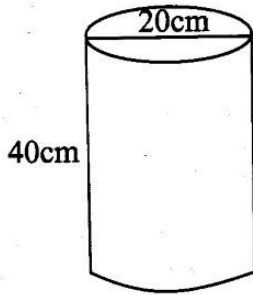

- A. 2826cm^2
 B. $12\ 560\text{cm}^2$
 C. $3\ 640\text{cm}^2$
 D. 3140cm^2
20. Alice sold a pair of shoes for sh. 640 after giving the customer a discount of sh. 80. Calculate the percentage discount the customer received.
 A. $11\frac{1}{9}\%$
 B. $12\frac{1}{4}\%$
 C. 10%
 D. 15%
21. The median of 6 numbers is 32 five of the numbers are 24, 29, 34, 35 and 31. What is the sixth number?
 A. 33
 B. 31
 C. 30
 D. 32
22. Calculate the area of the shaded part in the figure below.

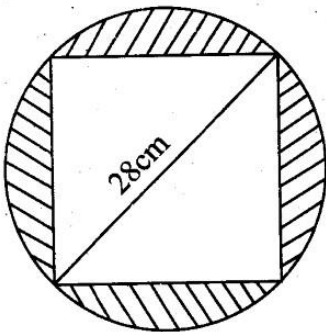

- A. 616cm^2
 B. 224cm^2
 C. 392cm^2
 D. 168cm^2

23. A staff meeting started at 0955hrs. It lasted for $2\frac{1}{3}$ hours before going for 50 minutes lunch break. They then continued for another session which took 1 hour 55 minutes. At what time did the meeting end?
 A. 2.10pm
 B. 2.00am
 C. 2.30pm
 D. 3.00pm
24. There were 400 pupils at Malezi Bora academy. Each pupil received a glass of milk twice a week. If each glass contained 220ml, how many litres did the pupils receive in two weeks?
 A. 172
 B. 352
 C. 35200
 D. 352 000
25. Janet borrowed sh. 18 000 from a bank. After $2\frac{1}{2}$ years he repaid a total of sh. 20 700 which included the interest earned. At what rate percent per annum was the money earning the interest?
 A. 5%
 B. 12%
 C. 10%
 D. 6%

26. What is the value of

$$\frac{y(x+z)}{2x-z}$$

If $x = 4$, $y = \frac{1}{2}x$ and $z = 3$

- A. $2\frac{4}{5}$
 B. $4\frac{4}{5}$
 C. 6
 D. $6\frac{1}{2}$

27. The container below was half full of water.

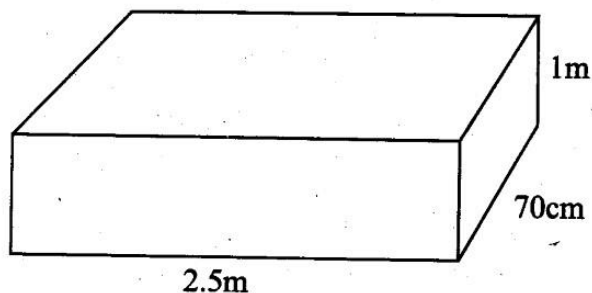

The water in the container was then emptied into 25dl containers. How many containers of water were obtained?

- A. 700
B. 87.5
C. 875
D. 350
28. A watch gains 10 seconds every hour. It was set right on Tuesday 11:56am. What time did it show on Friday the same week when the correct time was 11:56a.m?
- A. 12.08am
B. 12.08pm
C. 11.44am
D. 11.44pm
29. WXYZ represents a rhombus. Angle $\text{XWZ} = 3\frac{1}{2}x$, while angle $\text{WXY} = 2\frac{1}{2}x$.

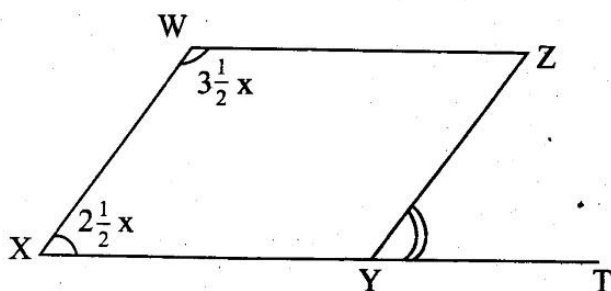

What is the size of angle ZYT?

- A. 105°
B. 75°
C. 85°
D. 115°

30. The distance between two schools is 900 metres. A safari car took 20seconds to cover that distance. Calculate the speed of the car in km/h
- A. 180km/h
B. 108km/h
C. 144km/h
D. 162km/h

31. This year Tujijenge women group saved sh. 15 680. This is 12% more than the amount they saved last year. How much more money did they save this year than last year?
- A. sh. 1680
B. sh. 1400
C. sh. 14 000
D. sh. 2400

32. The total surface area of a closed cube is 1350cm^2 . What is the volume of the cube?
- A. 225cm^3
B. 1125cm^3
C. 2550cm^3
D. 3375cm^3

33. Jane is 3 times younger than her mother who is 8 years younger than her husband. The sum of their ages is 93. If the age of her mother is represented by x , write an equation to find the sum of their ages.

- A. $2\frac{1}{3}x - 8 = 93$
B. $2\frac{1}{3}x + 8 = 93$
C. $2\frac{1}{2}x + 3 = 93$
D. $2\frac{1}{2}x + 8 = 93$

34. The scale of a map reads 1:20 000. Calculate the actual area of the rectangular piece of land drawn below using the scale given.

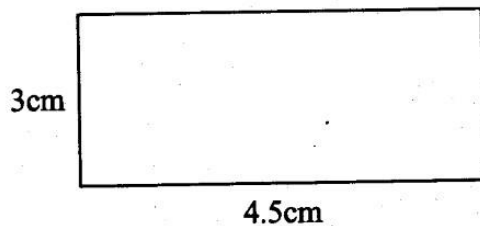

- A. 27ha
 B. 2.7ha
 C. 5.4ha
 D. 54ha
35. The area of a circle is 616cm^2 . What is its circumference?

(Take $\pi = \frac{22}{7}$)

- A. 168cm
 B. 132cm
 C. 88cm
 D. 44cm
36. In the diagram below line **WX** is parallel to **YZ**, **BY** and **ABCD** are transversals. Angle **BYC** = 68° and angle **DCZ** = 47° . What is the size of angle **WBY**?

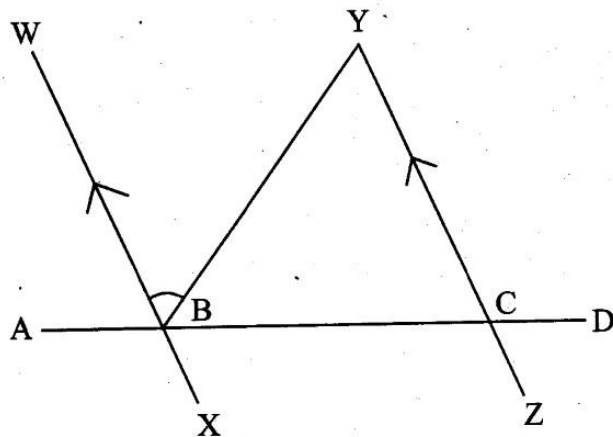

- A. 133°
 B. 47°
 C. 65°
 D. 68°

37. The area of the rectangle below is 360cm^2 . The width is 9cm.

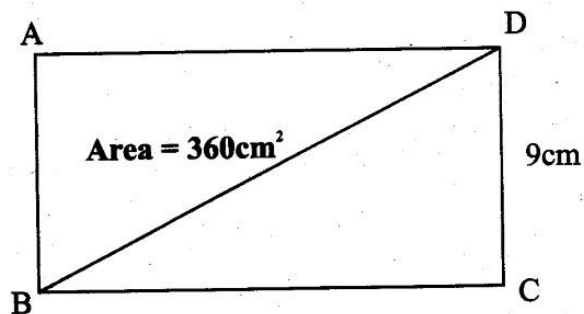

What is the length of line **BD**?

- A. 41cm
 B. 40cm
 C. 45cm
 D. 35cm
38. A trader sold a pair of shoes for sh. 784 making a profit of 12%. How much profit would he have made if he sold the pair of shoes for sh. 890?

- A. sh. 106
 B. sh. 190
 C. sh. 84
 D. sh. 116

39. 9 workers received sh. 3150. How much more did they receive than what 7 workers received if they were being paid at the same rate?
- A. sh. 350
 B. sh. 800
 C. sh. 2450
 D. sh. 700

40. The table below shows commission on money orders sent through the post office.

Value of order in shillings	Commission	
	sh	cts
Not over 500	45	00
Over 500 upto 1000	78	00
Over 1000 upto 2000	125	00
Over 2000 upto 5000	278	00
Over 5000 upto 10 000	524	00

Emma sent 2 money order each worth sh. 8900 and another one worth sh. 4700. How much money did she pay at the post office altogether?

- A. sh. 13600
- B. sh. 23826
- C. sh. 1326
- D. sh. 22500

41. What is the volume of the triangular prism drawn below?

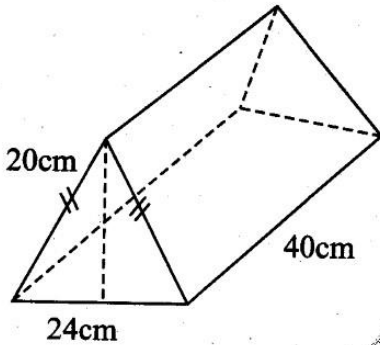

- A. 9600cm^3
- B. 7680cm^3
- C. 15320cm^3
- D. 3840cm^3

42. The table below shows the number of shoes sold by a Bata shoe shop at Nairobi in one month.

Shoe size	2	3	4	5	6	8
No. of shoes sold	2	7	12	9	2	2

Calculate the total number of shoes sold that month.

- A. 28
 - B. 63
 - C. 34
 - D. 154
43. Construct triangle PQR in which line $QR = 8\text{cm}$, angle $PQR = 105^\circ$ and angle $QRP = 40^\circ$. Draw a circle touching the three lines of the triangle. What is the radius of the triangle?
- A. 3cm
 - B. 1.9cm
 - C. 2.2cm
 - D. 4.4cm

44. How many cubes are used to make this stack?

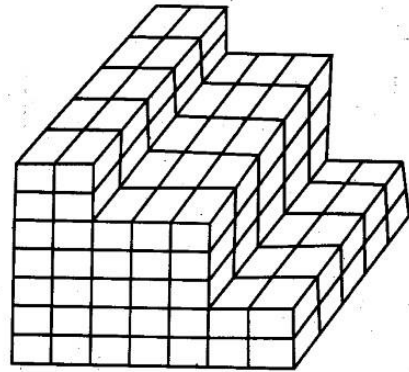

- A. 165
- B. 245
- C. 70
- D. 125

45. Solve the value of y in

$$5y - 5 + 6 = 2y + 3$$

- A. $\frac{2}{3}$
- B. 1
- C. 3
- D. $1\frac{1}{3}$

46. A saleslady received a total of sh. 16 700 in the month of March. Her basic salary is sh. 4200. She receives a commission on value of goods sold above sh. 75 000. If she had sold goods worth sh. 175 000 that month, calculate her percentage commission.

- A. 12%
- B. 10%
- C. $12\frac{1}{2}\%$
- D. 7.14%

47. The pie chart below shows the number of different types of utensils found in Mama Mark's kitchen.

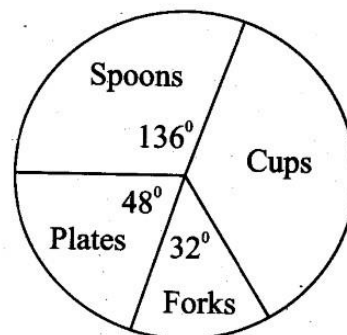

There are 54 cups in her kitchen. How many plates and forks are there in her kitchen?

- A. ~~30~~ 40
- B. ~~21~~ 20
- C. ~~97~~ 90
- D. 24 60

48. Work out the difference in the product of faces and edges and the sum of vertices and faces of an open cube.

- A. 20
- B. 27
- C. 47
- D. 13

49. The charges of sending a telegram is sh. 10 for the first ten words or less. Any word after the ten words is charged sh. 2. A tax of 15% is charged on the total amount. Commas, fullstops and abbreviations are counted as words. What is the cost of sending the following telegram?

JOHN KIAMA BOX 97403 KISII COMING HOME FOR EASTER HOLIDAY. PREPARE TO WELCOME ME NDONGO

- A. sh. 22.00
- B. sh. 23.00
- C. sh. 25.30
- D. sh. 25.00

50. The graph below shows the journey followed by two cyclist travelling on the same route but from different directions.

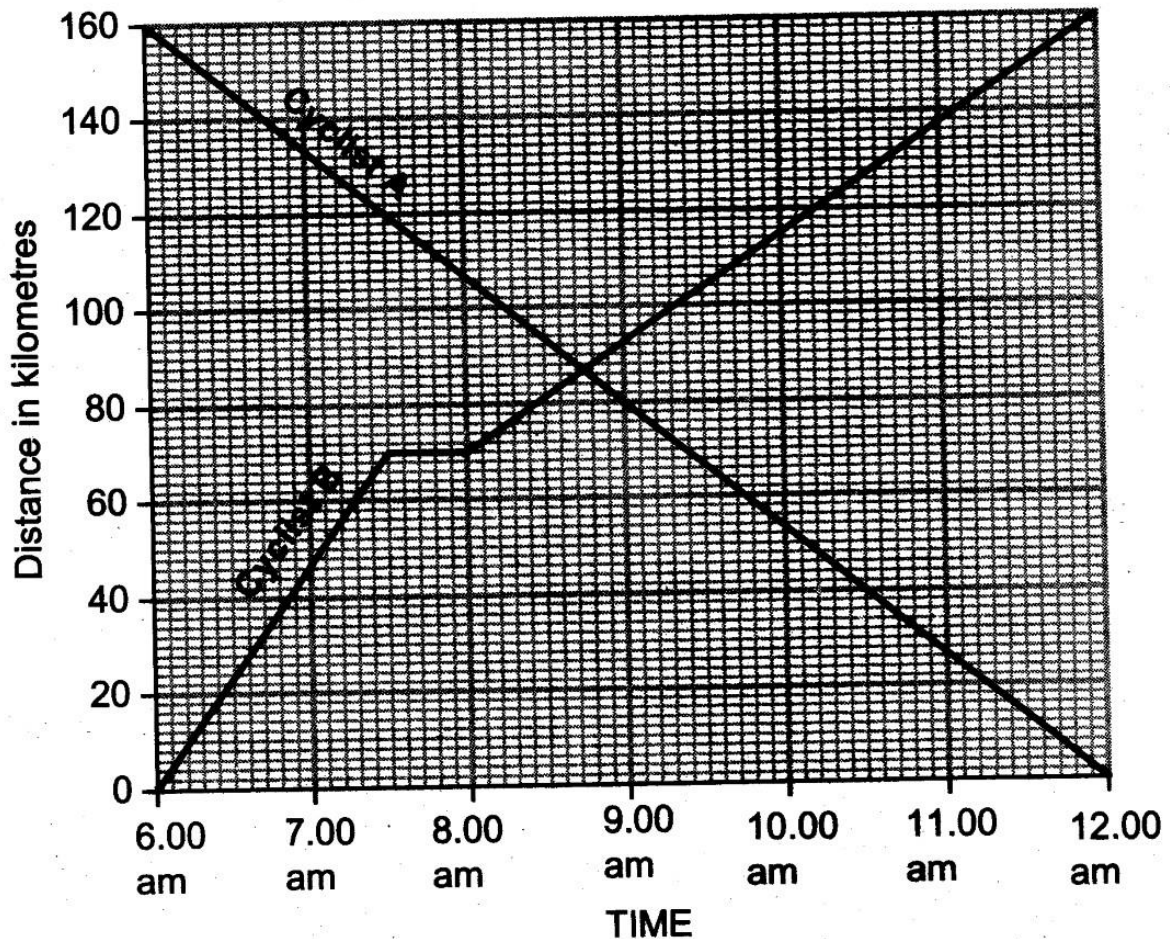

How many kilometres were remaining for cyclist B when they met?

- A. 87km
- B. 73km
- C. 85km
- D. 60km

SCIENCE

STANDARD EIGHT - 2015

INSTRUCTIONS TO CANDIDATES (read these instructions carefully)

1. You have been given this question booklet and a separate answer sheet. The question booklet contains 50 questions.
2. Do any necessary rough work in this booklet.
3. When you have chosen your answer, mark it on the **ANSWER SHEET**, not in the question booklet.

HOW TO USE THE ANSWER SHEET.

4. Use an ordinary pencil only.
5. Make sure that you have written on the answer sheet:-

YOUR INDEX NUMBER

YOUR NAME

NAME OF YOUR SCHOOL

6. By drawing a **dark line** inside the correct numbered boxes, mark your full Index Number (i.e. School Code Number and the three-figure Candidate's Number) in the grid near the top of the answer sheet.
7. Do not make any marks outside the boxes.
8. Keep the sheet as clean as possible and **DO NOT FOLD IT**.
9. For each of the questions 1-50, four answers are given. The answers are lettered A, B, C and D. In each case, only **ONE** of the four answers is correct. Choose the correct answer.
10. On the answer sheet, show the correct answer by drawing a **dark line** inside the box which has the letter you have chosen is written.

Example:-

In the Question Booklet:

16. Which one of the following crops is the odd one out?
- A. Beans.
 - B. Oats.
 - C. Rice.
 - D. Wheat.

The correct answer is A.

On the Answer sheet:

14. [A] [B] [C] [D] 15. [A] [B] [C] [D] 16. [A] [B] [C] [D] 17. [A] [B] [C] [D]

In the set of boxes number 16, the box with letter A printed in it is marked.

11. Your **dark line** **MUST** be within the box.
12. For each question, **ONLY ONE** box is to be marked in each set of four boxes.

This question paper consists of 7 printed pages.

Published and printed by Targeter Educational Publishers Ltd.

Email: exams@targeterpublishers.co.ke

TURN OVER

1. Which one of the following is **not** part of the female reproductive system?
 - A. Cervix.
 - B. Urethra.
 - C. Ovum.
 - D. Fallopian tube.

2. Which of the following is the **main** waste excreted by the kidney
 - A. Nitrogenous wastes.
 - B. Lactic acid.
 - C. Salts.
 - D. Water.

3. The following are functions of the amniotic fluid **except** one. Which one?
 - A. It enhances exchange of respiratory gases.
 - B. It prevents the foetus from drying.
 - C. It protects the foetus from bumps and shock.
 - D. The baby balances on that fluid.

Below is a diagram of the mammalian heart. Use it to answer questions 4 and 5.

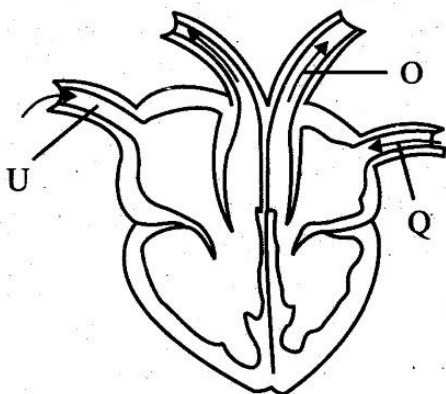

4. Which of the following statements is **not** true about the blood vessel **O**?
 - A. Blood in it is under pulse.
 - B. It carries scarlet red blood.
 - C. It has valves.
 - D. The blood in it is rich in oxygen.

5. What is the correct name of blood vessels **Q** and **U** respectively?
 - A. Aorta and venacava.
 - B. Pulmonary vein and venacava.
 - C. Venacava and aorta.
 - D. Venacava and pulmonary vein.

6. Which one of the following food is **not** part of the foods that protect the body from infections?
 - A. Kales.
 - B. Water melon.
 - C. Ripe bananas.
 - D. Fried eggs.

7. Which statement below is true about the soil that can make the longest ribbons?
 - A. It has the poorest water retention ability.
 - B. It cracks when exposed to heat.
 - C. It has the largest air spaces.
 - D. Is the best for construction.

8. Which of the following is an effect of HIV to the infected?
 - A. Children become orphans.
 - B. Congestion in hospitals.
 - C. Widowhood.
 - D. Lack of strength to work.

9. What is convection?
 - A. The transfer of heat through liquid.
 - B. The transfer of heat through gas.
 - C. The transfer of heat through solids.
 - D. The transfer of heat through liquids and gases.

10. Which of the following list comprises of insulators **only**?
 - A. Wood, nail, chalk.
 - B. Plasticine, chalk, paper.
 - C. Ash, officepin, glass.
 - D. Glass, chalk, steel rod.

11. The diagram below shows the human organ of the excretory system.

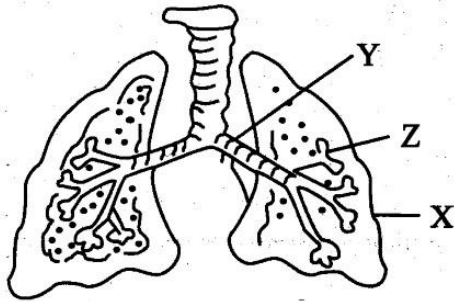

What are the names of the parts labelled X, Y and X respectively?

- A. Air sacs, bronchus, left lung.
 B. Left lung, bronchus, air sac.
 C. Bronchus, left lung, air sac.
 D. Air sacs, bronchus, right lung.
12. Which of the following internal parasites affect the sheep and goats most?
- A. Roundworms.
 B. Lungworms.
 C. Hookworms.
 D. Tapeworms.
13. Which one of the following is the least reason why one should go for HIV testing?
- A. To campaign against the diseases.
 B. To prepare for his death incase he is HIV positive.
 C. To choose a marriage partner.
 D. To live positively.
14. Which vaccines are immunized to infants immediately after birth and after 9 months respectively ?
- A. BCG and anti-measles.
 B. Anti- polio and DPT.
 C. DPT and BCG.
 D. Anti-measles and Anti-polio.

15. Which one of the following crop pests attacks the crop by piercing and sucking the plant sap?

- A. Aphids.
 B. Weevils.
 C. Cutworms.
 D. White ants.

16. The following are factors that determine the agent of pollination of a particular flower. Which one is **not**?

- A. The brightness of the flower.
 B. The type of root system the plant has.
 C. The size of the flower.
 D. The mass of the pollen grains.

17. Sixteen pupils did the experiment illustrated below to investigate sinking and floating

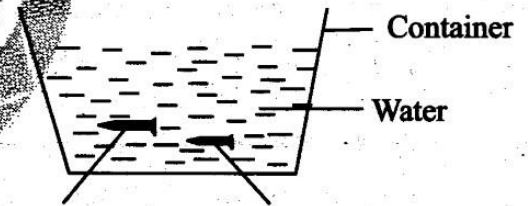
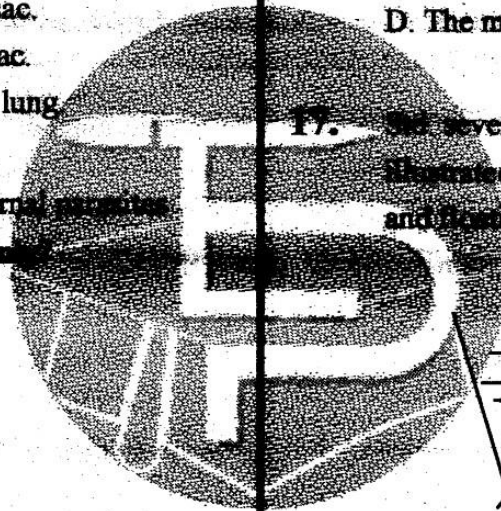

- Which conclusion did the pupils make from the experiment?

- A. Shape affects sinking and floating.
 B. Size does not affect sinking and floating.
 C. The two nails sank on the water.
 D. Type of material affects sinking and floating.
18. The best method of removing the unwanted plants that grow at the shamba is by,
- A. uprooting
 B. using chemicals
 C. burning
 D. slashing them.

19. Which type of organic manure is made by cutting the young green growing plants and covering them with the soil to rot after a period of time?
- Farmyard manure.
 - Compost manure.
 - Green manure.
 - Organic mulches.

Below is a diagram of a certain weather instrument. Use it to answer question 20.

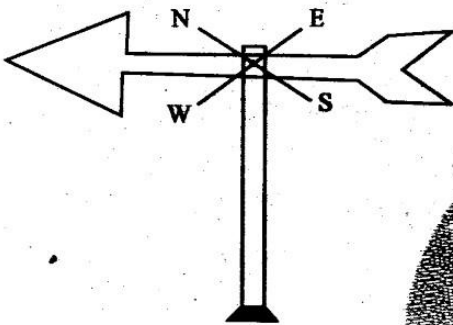

20. Which one of the following statements is true about the weather instrument drawn above?
- It measures the strength of wind.
 - The tail should be larger than the head.
 - The head should be larger than the tail.
 - The arrow points the direction to which the wind is blowing.

21. Which one of the following planets is nearest to the largest planet?
- Venus.
 - Mercury.
 - Mars.
 - Neptune.

22. Which method of grazing involves use of movable electric fence?
- Stall grazing.
 - Paddock grazing.
 - Strip grazing.
 - Herding.

23. The most effective method of controlling the spread of malaria is by doing one of the following. Which one?
- Destroying the areas in which mosquitoes breed.
 - Covering yourself with well treated mosquito nets.
 - Taking anti - malarial tablets.
 - Eating a balanced diet.

24. The diagram below shows a type of soil erosion that took place on a given area.

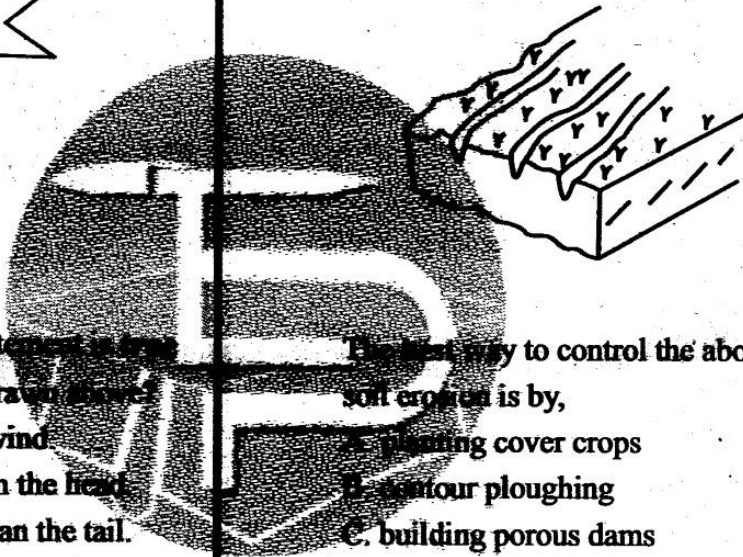

The best way to control the above type of soil erosion is by,

- planting cover crops
 - contour ploughing
 - building porous dams
 - using cut-off drains.
25. The type of animal feed that is given to animals to supplement the normal or the daily food are also referred to as,
- silage
 - concentrates
 - fodder crops
 - pasture.
26. Which one of the following food preservation methods preserves food by preventing bacteria from reaching the food?
- Use of honey.
 - Deep freezing.
 - Salting.
 - Smoking.

27. The following are uses of light. Which one is **not**?
- A. Making plant foods.
 - B. Photography.
 - C. Warming.
 - D. Seeing clearly.

28. Std. four pupils mixed soil with water. They then left the soil to settle as shown below.

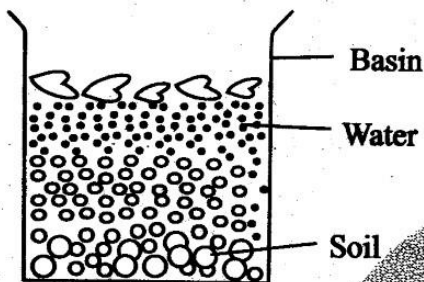

Which aspect of soil were the pupils investigating?

- A. Soil has water.
 - B. Soil has living organisms.
 - C. Soil has air.
 - D. Soil has organic matter.
29. Which one of the following body organs is not directly involved in excretion?
- A. Skin.
 - B. Liver.
 - C. Kidney.
 - D. Lungs.
30. The two gases that are commonly produced at the industries that leads to the formation of acid rain are _____ and _____
- A. oxygen and sulphur dioxide
 - B. sulphur dioxide and carbon dioxide
 - C. carbon dioxide and hydrogen
 - D. sulphur dioxide and rare gases.

31. Which of the following statements is **not** true about insects?
- A. All insects have wings.
 - B. Insects breathe by use of spiracles.
 - C. Insects have 3 pairs of legs.
 - D. Insects have three body parts.

32. Which list below is made up of only plants that have chlorophyll but they do not produce flowers?
- A. Fern, grass, algae.
 - B. Kales, fern, pine.
 - C. Cypress, conifers, cedar.
 - D. Cactus, fern, cedar.

33. The pie-chart below shows the composition of air

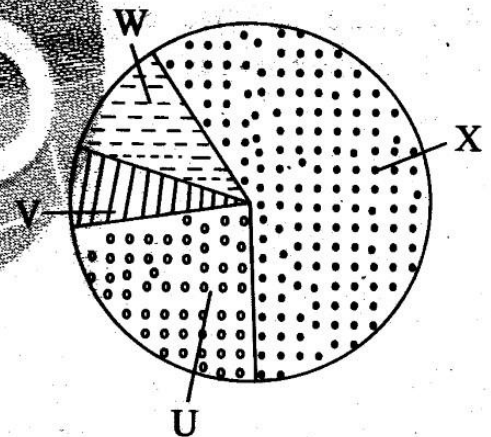

The gas that is used by plants in making plant proteins is marked by letter,

- A. U
 - B. V
 - C. W
 - D. X
34. Which one of the following types of teeth is **correctly** matched with the type of shape it has?
- A. **Incisors** - have two roots.
 - B. **Canines** - sharp pointed.
 - C. **Molars** - have a chisel shape.
 - D. **Pre-molars** - have three roots.

35. Below is a description of a type of cloud.
- (i) They indicate fine weather
(ii) They appear like cotton wool
- The type of clouds described above are called;
- cumulus
 - white clouds
 - nimbus
 - dark grey clouds.

36. In which of the following uses of water is water used for recreation purpose?
- Irrigating crops.
 - Making fountains.
 - Scenery.
 - Watering animals.

37. What is the main function of the red colouring pigment that is present in blood?
- To give blood its red colour.
 - To transport oxygen.
 - To transport digested food.
 - To mix with oxygen.

The diagram below shows a flower. Use it to answer questions 38 and 39.

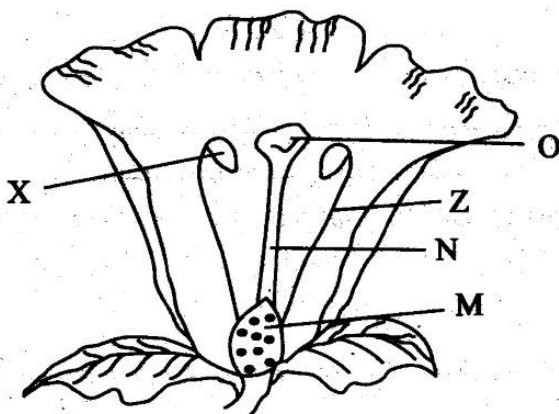

38. In which of the above labelled parts does development of the pollen dust take place?
- M
 - X
 - O
 - N

39. Mandrax, cocaine and bhang all share three of the following factors except one. Which one is it?
- All are narcotics.
 - All cause addiction.
 - All cause depression.
 - All cause hallucination.

40. Which one of the following is not a safety precaution when dealing with lightning?
- Avoid sheltering under trees when it's raining.
 - Do not walk on water when there is lightning.
 - Fit tall building with arrestors made of a thin copper wire.
 - Fit all building with arrestors made of a thick copper wire.

41. The substance that causes addiction present in tea and coffee is known as,
- nicotine
 - caffeine
 - tar
 - ethanol.

42. The force of gravity acting on a given object can be determined by the use of a,
- spring balance
 - beam balance
 - weighing balance
 - gravity balance.

43. Which one of the following is the main air pollutant in the urban areas?
- Aerosol sprays.
 - sewage effluents.
 - Floods.
 - Industrial gases.

44. The diagram below represents a maize seed;

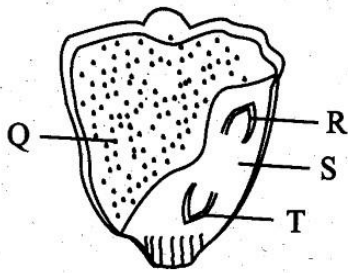

Which one of the labelled parts protects the radicle and the plumule of the seed?

- A. Q
 B. R
 C. S
 D. T
45. Which one of the following is **not** a sign that can be seen or experienced by an expectant mother within 2 months old pregnancy?
- A. Stoppage of menstruation.
 B. Breast may be tender and soft.
 C. Foetus movement.
 D. Vomiting mostly during morning hours.
46. Below are signs and symptoms of a certain waterborne disease.
 (i) *The body is dehydrated*
 (ii) *The patient diarrhoeas mucus*
 (iii) *Death within a day*
 The above description are for _____
- A. cholera
 B. bilharzia
 C. typhoid
 D. dysentery.
47. Which one of the following groups is made up of non-magnetic materials **only**?
- A. Steel and iron.
 B. Copper and aluminium.
 C. Copper and iron.
 D. Chromium and aluminium.

48. Beth took two balloons, she inflated them then she rubbed one of them on her blanket. She then brought them into contact as shown below.

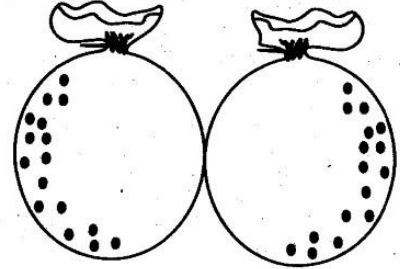

What happened to the two balloons?

- A. They bursted.
 B. They attracted and then repelled.
 C. They repelled each other.
 D. They attracted each other.
49. Which part of the male reproductive system secretes the fluid responsible of carrying sperms?
- A. Testes.
 B. Semen.
 C. Glands.
 D. Spermduct.
50. Pressure in liquids depends on,
- A. height
 B. surface area
 C. volume
 D. depth.

TARGETER **KCPE** TRACKER

Series
003

YEAR 2015

MARKING SCHEME

MATHS	ENGLISH	KISWAHILI	SCIENCE	S/STUDIES/R.E
1. D	1. C	1. D	1. B	1. A 51. C
2. C	2. A	2. B	2. D	2. B 52. A
3. A	3. B	3. C	3. A	3. B 53. B
4. B	4. C	4. A	4. C	4. D 54. A
5. C	5. B	5. B	5. B	5. B 55. C
6. A	6. D	6. D	6. D	6. C 56. C
7. D	7. D	7. A	7. B	7. A 57. A
8. D	8. A	8. B	8. D	8. D 58. B
9. C	9. B	9. A	9. D	9. B 59. A
10. B	10. D	10. B	10. B	10. D 60. D
11. D	11. C	11. C	11. B	11. C
12. C	12. C	12. D	12. C	12. A <u>RE</u>
13. B	13. B	13. C	13. B	13. D
14. A	14. A	14. B	14. A	14. C 61. D
15. D	15. D	15. C	15. A	15. D 62. C
16. C	16. B	16. A	16. B	16. C 63. A
17. B	17. C	17. D	17. B	17. C 64. B
18. B	18. D	18. B	18. A	18. D 65. B
19. D	19. A	19. C	19. C	19. B 66. C
20. A	20. B	20. A	20. B	20. A 67. C
21. A	21. D	21. D	21. C	21. D 68. B
22. B	22. B	22. B	22. C	22. B 69. C
23. D	23. C	23. A	23. A	23. B 70. A
24. B	24. A	24. C	24. C	24. A 71. B
25. D	25. D	25. C	25. B	25. D 72. C
26. A	26. B	26. A	26. A	26. B 73. A
27. D	27. A	27. D	27. C	27. B 74. B
28. B	28. C	28. C	28. D	28. A 75. D
29. B	29. D	29. D	29. B	29. B 76. D
30. D	30. B	30. C	30. B	30. C 77. D
31. A	31. C	31. A	31. A	31. A 78. D
32. D	32. A	32. D	32. C	32. B 79. B
33. B	33. D	33. D	33. D	33. A 80. A
34. D	34. D	34. C	34. B	34. D 81. C
35. C	35. C	35. B	35. A	35. A 82. D
36. D	36. A	36. C	36. C	36. D 83. A
37. A	37. C	37. A	37. D	37. A 84. C
38. B	38. D	38. D	38. B	38. A 85. B
39. D	39. B	39. C	39. C	39. A 86. D
40. B	40. C	40. C	40. C	40. D 87. A
41. B	41. A	41. D	41. B	41. B 88. B
42. C	42. C	42. A	42. A	42. D 89. D
43. C	43. B	43. C	43. D	43. C 90. C
44. A	44. D	44. B	44. C	44. A
45. A	45. D	45. C	45. C	45. C
46. C	46. C	46. D	46. A	46. A
47. A	47. C	47. A	47. B	47. B
48. C	48. D	48. C	48. D	48. D
49. C	49. B	49. B	49. C	49. C
50. B	50. D	50. A	50. D	50. B

GATITU PRIMARY SCHOOL
P. O. BOX 260
RUIRU
DATE: 4/5/11