

KIRINYAGA COUNTY MOCKS

2014

TIME: 40 MINUTES

STD 8

**ENGLISH
SECTION B
COMPOSITION**

INDEX NUMBER.....

YOUR NAME

NAME OF YOUR SCHOOL

READ THESE INSTRUCTIONS CAREFULLY

- 1. IN THE SPACES PROVIDED ABOVE, WRITE YOUR FULL NAMES, INDEX NUMBER, YOUR SCHOOL NAME**
- 2. NOW OPEN THIS PAGE, READ THE HEADING OF THE COMPOSITION CAREFULLY AND WRITE YOUR COMPOSITION ON THE LINES PROVIDED.**

POWERED BY: www.eeducationgroup.com

This paper contains 4 printed pages

KIRINYAGA COUNTY MOCKS

2014

ENGLISH

SECTION A
LANGUAGE

STD 8

TIME 1HR 40 MIN

READ THESE INSTRUCTIONS CAREFULLY

1. You have been given this booklet and a separate answer sheet. The question booklet contains 50 questions.
2. Do any necessary rough work in this booklet
When you have chosen your answer, mark it on the Answer sheet, not in this question booklet.

HOW TO USE THE ANSWER SHEET

4. Use only an ordinary pencil.
5. Make sure that you have written on the answer sheet:

YOUR INDEX NUMBER

YOUR NAME

NAME OF YOUR SCHOOL

6. By drawing a dark line inside the correct numbered boxes mark your full Index Number (i.e School Code Number and the three-figure Candidate's number) in the grid near the top of the answer sheet.
7. Do not make any marks outside the boxes.
8. Keep the sheets as clean as possible and do not fold it
9. For each of the questions 1-50 four answers are given. The answers are lettered A, B, C and D. In each case only ONE of the four answers is correct. Choose the correct answer.
On the answer sheet the answer is to be shown by drawing a dark line inside the box in which the letter you have chosen is written.

Example

In the Question Booklet:

9. For question 9, choose the alternative that best completes the sentence
She passed her exams very well, _____ ?
A. is it B. did she C. didn't she D. isn't it
The correct answer is C.

On the answer sheet:

9. [A]. [B]. [~~C~~]. [D].
In the set of boxes numbered 9, the box with the letter C printed in it is marked.
11. Your dark line **MUST** be within the box.
12. For each question **ONLY ONE** box is to be marked in each set of four boxes.

Turn over

Read the passage below. It contains blank spaces numbered 1 to 15. For each blank space choose the BEST answer from the choices given.

The way we relate _____ 1 _____ other people _____ 2 _____ whether our lives _____ 3 _____ be happy or not. _____ 4 _____ It is important to choose our friends _____ 5 _____. If you have the wrong kind of friends, your life _____ 6 _____ be miserable, full of pain and _____ 7 _____. You need to associate with those who love and accept you just as you are. They are likely to bring joy _____ 8 _____ your life. People who possess the following qualities are the right ones to befriend. First of all, go _____ 9 _____ those who respect you. Those who _____ 10 _____ you to be yourself, listen to you and care _____ 11 _____ your feelings. _____ 12 _____ People do not despise you _____ 13 _____ say things that make you feel small or useless. You see, certain people are so full of themselves _____ 14 _____ they do not value anyone _____ 15 _____ opinion.

- | | A | B | C | D |
|-----|----------------|----------------|---------------|----------------|
| 1. | with | among | for | to |
| 2. | describes | determines | resolves | decides |
| 3. | would | will | should | can |
| 4. | However | And | Therefore | Moreover |
| 5. | reluctantly | truthfully | selectively | carefully |
| 6. | can | would | might | could |
| 7. | disappointment | disappointment | disappointing | disappointment |
| 8. | for | into | of | in |
| 9. | to | with | for | into |
| 10. | allow | resist | let | admit |
| 11. | for | over | to | about |
| 12. | Many | Such | Most | The |
| 13. | or | but | and | although |
| 14. | when | while | that | but |
| 15. | else | else's | else's | else's |

Select the appropriate alternatives to complete questions 16 – 20

16. Only after the pupils have completed their work _____ the teacher collect the books.
A. shall B. that
C. will D. does
17. Not only did John get late to school but _____.
A. he also did not sit his exams
B. also he did not sit his exams
C. he did not also sit his exams
D. did not sit his exams also
18. Somebody attacked our school driver _____?
A. did they B. didn't they
C. didn't he D. isn't it
19. All the books _____ he bought are lost.
A. whom B. which
C. like D. that
20. The coach went around dropping _____ player home after the practice.
A. each B. every
C. each and every D. some

Choose the best alternative for question. 21

21. The sailor said, "We must leave tomorrow."

- A. The sailor said that they had to leave the following day
B. The sailor said that they would have to leave the next day
C. The sailor said that they had to leave tomorrow
D. The sailor said that they would leave tomorrow

Complete the following questions with the most suitable alternative

22. Tom failed to attend lessons last week _____ he still passed his exams with flying colors.
A. however B. but
C. nonetheless D. although
23. It is I who _____ sick.
A. am B. is
C. are D. were

For question 24, give the word that means the same as the underlined phrase

24. The lady broke down when she saw her damaged car.
A. died B. fainted
C. Cried D. collapsed

For question 25, fill in the gaps appropriately.

25. The choirmaster left through the _____ end of the hall after the concert.
A. longest B. furthest
C. farthest D. further

Read the following passage and answer questions 26 -38.

Asara assured his father proudly that he would be able to take care of everything as he was a big boy. He promised to take the pots to the market on the market day. Satisfied that all would be well in his absence, Kisambo left the homestead very early the next morning and Asara was left on his own. Kisambo repeatedly stressed the importance of returning home early as though he had some doubts in the young boy.

"Remember, my son, go home straight away after you have sold your pots at the market. Don't let anything delay you." Asara promised his father then stood watching as he left on his long journey. Kisambo was dressed in a warm cloak as it was very cold. Asara watched until his father was out of sight then started his day's work in the shamba and attending to the animals.

He felt proud that he had been left in charge of everything. At first Asara felt lonely for it was the first time he had ever been left on his own. He missed his father's company but he kept himself busy looking after the animals and the small garden and after his work was done, he made his little earthen wave bowls. By the time the market day came around, he had quite a sackful of pots and bowls to take to the market. Asara set out from home before dawn and when he arrived at the market place, several of his father's friends were already busy selling their wares. He laid his pots and bowls out next to Indasi's.

26. What do you learn about the character of Asara ?
- A. proud B. confident
C. timid D. brave
27. What errand was Asara to run on behalf of his father?
- A. sell the pots on the market day
B. take the pots from the market
C. take care of cattle
D. ferry the pots to the market and sell them
28. What would you deduce was the relationship between Asara and his father.
- A. trust B. happiness
C. distrust D. absence
29. According to the first paragraph, it is true to say that
- A. Kisambo never trusted Asara at all
B. Kisambo was actually doubtful of Asara
C. Kisambo was never at all doubtful of Asara
D. Kisambo seemed doubtful of Asara
30. According to the passage, who was Kisambo to Asara ?
- A. business partner B. son
C. father D. uncle
31. Where was Asara's father going?
- A. on a long journey
B. to the market
C. to their home
D. to look for Asara

32. Which of the following describes how Kisambo was dressed?
- A. in a cold cloak B. ordinarily
C. warmly D. beautiful cloak
33. What did Asara do after his father left?
- A. slept
B. reared cattle
C. went to the farm
D. went to the market immediately
34. Why did Asara feel proud?
- A. he would accompany his father on a journey
B. he had been left in charge
C. he had to return home without delay
D. he would be ferrying pots to the market
35. What distracted Asara from his loneliness?
- A. domestic work
B. selling of pot
C. feeding cattle
D. visiting friends
36. The phrase set out as underlined in the passage means
- A. plan B. leave for a journey
C. arrange D. spare for the future use
37. What did Asara realize on reaching the market?
- A. many of his father's friends had arrived
B. not many of his father's friends had arrived
C. A number of his father's friends had arrived
D. most of his father's friends had arrived
38. Which of the following summarizes the story?
- A. The lonely Asara
B. A market day
C. Asara and his father
D. Asara's visit to the market

Read the passage below then answer questions 39 – 50.

In most countries tourism is the major foreign exchange earner. It is a trade in its own right. Kenya is one such country. The reason that makes Kenya a tourist destination is diverse.

The country boasts of having many game parks, game reserves and national parks, homes for the games. That is not enough, it has a beautiful coastline and modern beach hotels. Talk of food! Her food is as diverse as the different cultures of its people. It is usual to see people sampling different traditional dishes during community nights like Maasai night, Kamba night, Luhya night to name just but a few.

When one is on safari in Kenya, Nairobi National Park is just at the doorstep. When one moves on to the Rift Valley, the landscape is breathtaking. One can view the floor of the Rift Valley from the escarpment. As you enjoy the aftermath of great volcanic eruptions, the skills of art are on display along the road. You can buy the curio of different cultural origins. If one wants to be in a forest and hilly areas that a meal is served together with the snow capped Mt. Kenya at the centre of the country which lies along the equator. What a wonder!

39. What do we learn from the first sentence?
- A. Tourism is the sole foreign exchange earner in many countries
 - B. All countries invest in tourism as major foreign exchange earner
 - C. tourism is one of the principal foreign exchange earners in many counties
 - D. countries delve least in tourism as foreign exchange earner
40. What do we understand by the phrase, "It is a trade in its own right."
- A. tourism enjoys its own existence
 - B. tourism relate to other trade sectors
 - C. tourism encompasses other trade
 - D. without other trade tourism has no existence
41. What do we understand about reasons that make Kenya a tourist destination?
- A. sights are rare
 - B. sights are non-diverse
 - C. sights need to be diverse
 - D. sights are varied
42. What do we deduce about the Kenyan people from the passage?
- A. share a culture
 - B. enjoy varied cultures
 - C. they are numerous
 - D. are united by one culture
43. What can we say the distance of Nairobi National Park is?
- A. amazing
 - B. quite a distance away
 - C. within the vicinity
 - D. off the vicinity
44. The following are synonyms of breathtaking but?
- A. very exciting
 - B. very impressive
 - C. impression
 - D. very surprising
45. What do we learn about the diet of Kenya?
- A. of one type
 - B. varied
 - C. very delicious
 - D. easily available
46. What can we say is the pride of Kenya? It is a
- A. social culture
 - B. cultural Centre

- C. hospitality centre
- D. tourist Centre

47. What happens during respective cultural nights?
- A. there is enormous show cases of ability
 - B. Kenyans merely socialize
 - C. varied dancing skills are exhibited
 - D. there is display of varied traditional dishes
48. What is TRUE according to the passage?
- A. Kenya is one of the countries that booms with tourism
 - B. many countries thrive in tourism save Kenya

- C. Only Kenya thrives in tourism
- D. No country enjoys tourism as Kenya

49. What do we learn from the last paragraph?
- A. Mt. Kenya separates Kenya into two
 - B. Equator is at the edge of Kenya
 - C. The equator divides Kenya into two
 - D. Mt. Kenya is near the equator
50. What would be the best title for this passage?
- A. Importance of tourism
 - B. Tourism in Kenya
 - C. Wildlife in Kenya
 - D. The beautiful Kenya

KIRINYAGA COUNTY MOCKS

2014

DARASA LA NANE

**KISWAHILI
SEHEMU YA PILI
INSHA**

MUDA: DAKIKA 40

NAMBA YAKO YA MTHANI

JINA LAKO

JINA LA SHULE YAKO

MAAGIZO KWA MTAHINIWA

SOMA KWA MAKINI MAAGIZO YAFUATAYO

- 1. KWENYE NAFASI ZILIZOACHWA HAPO JUU ANDIKA NAMBA YAKO KAMILI YA MTHANI, JINA LAKO NA LA SHULE YAKO.**
- 2. SASA FUNGUA KARATASI HII, SOMA KICHWA CHA INSHA KWA MAKINI NA UANDIKE INSHA YAKO KWENYE NAFASI ULIOACHIWA.**

POWERED BY: www.eeducationgroup.com

Kijitabu hiki kina kurasa 4 zilizopigwa chapa

KIRINYAGA COUNTY MOCKS

2014

KISWAHILI

SEHEMU YA KWANZA

LUGHA

DARASA LA NANE

Muda Saa 1 dakika 40

**MAAGIZO KWA WATAHINIWA
SOMA KWA MAKINI MAAGIZO YAFUATAYO:**

1. Umepewa kijitabu hiki cha maswali na karatasi ya kujibia maswali .Kina maswali 50.
2. Ukisha chagua jibu lako lionyeshe katika **KARATASI YAMAJIBU** na wala sio katika hiki cha maswali
JINSI YA KUTUMIA KARATASI YA MAJIBU
3. Tumia penseli ya kawaida.
4. Hakikisha ya kwamba umeandika yafuatayo katika karatasi ya majibu.

**NAMBA YAKO YA MTHANI
JINA LAKO
JINA LA SHULE YAKO**

5. Kwa kuchora kistari katika visanduku vyenye namba zinazokuhusu, onyesha namba yako kamili ya mthani (yaani namba ya shule, na zile namba tatu za mtahiriwa) katika sehemu iliyitengwa mwanzo wa karatasi ya majibu.
6. Usitie alama zozote nje ya visanduku.
7. Iweke safi karatasi yako ya majibu na usiikunje
8. Kwa kila swali 1 - 50 umepewa majibu manne. Majibu hayo yameonyeshwa kwa herufi A, B, C, D, Nijibu MOJA tu kati ya hayo manne ambalo ni sahihi. Chagua jibu hilo.
9. Kwenye karatasi ya majibu, jibu sahihi lionyeshwe kwa kuchora kistari katika kisanduku chenye herufi uliyochagua kuwa ndilo jibu.

Mfano:

23 `Tunakimbiana` maana yake ni?

A. tunaogopana

B. tunahepana

C. tunasaidiana

D. tunachukiana

jibu sahihi ni B.

Katika karatasi ya majibu:

23. [A.] [B.] [C.] [D.]

10. Chora kistari chako vizuri. kiwe cheusi na kisijitokeze nje ya kisanduku
11. Kwa kila swali, chora kistari katika kisanduku kimoja tu kati ya visanduku vinne ulivyopewa.

JAZA PENGO KWA JIBU LIFAALO ZAIDI

Ukiwa _____ 1 _____ na matatizo yoyote usisite kumwuliza mwelekezi wako _____ 2 _____ ni muhimu kuwauliza wadadisi wengine ambao wana tajriba ya mambo hayo. Usitupilie _____ 3 _____ jambo linalokusumbua kwa sababu mwishowe litakuletea madhara makubwa. Ni muhimu kukumbuka nilivyotangulia kusema _____ 4 _____, nia yetu sio kuwaandaa wanafunzi _____ 5 _____ masomo pekee, bali _____ 6 _____ watu waliokamilika kiakili na kiutu. Hali hii haiwezi _____ 7 _____ ikiwa kila mmoja atajitenga kivyake. _____ 8 _____ tunaelewa umuhimu wa methali isemayo _____ 9 _____

- | | | | |
|--|----------------|----------------|---------------|
| 1. A. unakabidhiwa | B. unatingiwa | C. unakabiliwa | D. unatengwa |
| 2. A. Na | B. Aidha | C. Kisha | D. Lakini |
| 3. A. bali | B. kando | C. mbali | D. pote |
| 4. A. Kuwa | B. kwa | C. kua | D. huwa |
| 5. A. Wanaojua | B. wanaohitimu | C. Wanaosomea | D. Wanaomudu |
| 6. A. kuwaunda | B. kuwaenga | C. kuwakuza | D. kuwasarifu |
| 7. A. kuafikiwa | B. kufikia | C. kufikika | D. kufikisha |
| 8. A. Nyote | B. Sote | C. Zote | D. Yote |
| 9. A. Afadhali dooteni kama ambari kutanda | | | |
| B. Akikalia kigoda mtu | | | |
| C. Mkono mmoja haumlei mwana | | | |
| D. Ibilisi wa mtu ni mtu | | | |

Palizuka kimya kwa dakika kadha huku moyo _____ 10 _____ . Kanze _____ 11 _____ kichwa akanikazia macho _____ 12 _____ akayainamisha. Kuyainua tena akaanza kusema _____ 13 _____ sauti tulivu lakini imara, "Bwana Johari, uliyoyasema nimeyasikia lakini hii dhamira yangu ni kujenga nyumba ya matofali na kununua gari _____ 14 _____ . Miradi kama _____ 15 _____ inahitaji pesa nyingi."

- | | | | |
|-------------------|---------------|--------------|-----------------|
| 10. A. ukinituta | B. ikinidunda | C. ukinipiga | D. ukinidondoka |
| 11. A. alitingisa | B. alitingiza | C. alitikisa | D. alitikisika |
| 12. A. kisa | B. kisha | C. kiza | D. kicha |
| 13. A. wa | B. kwenye | C. kwa | D. na |
| 14. A. jipya | B. nzuri | C. mpya | D. ndogo |
| 15. A. unalosema | B. unayosema | C. unasema | D. umesema |

KUTOKA SWALI LA 16 MPAKA 30.
CHAGUA JIBU LILILO SAHIHI

16. Ningalijua anakoishi, ningalimuomba anisaidie: maana yake ni
- A. Nilipendelea kumwomba anisaidie lakini sikujua pa kumpata
 - B. Nilitaka kujua anakoishi ili anisaidie lakini sikumwona
 - C. Hakunisaidia kwa kutojua anakoishi
 - D. Sijuani naye, kwa hivyo hakunisaidia
17. Tano ni kwa chokaa. Kitita ni kwa _____
- A. Funguo
 - B. Ngozi
 - C. Pesa
 - D. Ndizi
18. Chagua wingi wa: Nyani ameruka ua mrefu
- A. Nyani wameruka maua marefu
 - B. Manyani wameruka nyua ndefu
 - C. Nyani wameruka nyua ndefu
 - D. Manyani wameruka maua marefu
19. Chagua kiwakilishi katika sentensi hii Kijana huyo alifuzu vizuri, yule alikata tamaa.
- A. Huyo
 - B. Alifuzu
 - C. Kijana
 - D. Yule
20. Sehemu ya kuweka au kuanikia kuni jikoni ni
- A. Dohani
 - B. Uchaga
 - C. Karo

- D. Susu
21. Miwani _____ lichafuliwa na mvua _____ liyonyesha
- A. Yangu/ya/ i
 - B. Yangu / i/ i
 - C. Zangu /zi/ i
 - D. Yangu /i/ u
22. Mtoto alikunywa chai _____ kisha akatapika
- A. Ndogo
 - B. Kidogo
 - C. Dogo
 - D. Mdogo
23. Kamilisha sentensi kwa kiunganishi sahihi
Juma aliadhibiwa _____ ya kufanya makosa.
- A. Mighairi
 - B. Licha
 - C. Bali
 - D. Dhidi
24. Thuluthi mbili ya waliohudhuria mkutano ilikuwa ni watu wazima. Kati ya hao sudusi moja ilikua wanawake. Idadi ya wanaume ilikuwa gani?
- A. Sudusi
 - B. Thuluthi
 - C. Robo
 - D. Nusu
25. Rais huja kwetu mara kwa mara. Vidozi vilivyopigwa mstari vina maana kuwa.
- A. Baada ya kitambo kidogo
 - B. Bila kikomo

- C. Moja kwa moja
D. Kila siku
26. Kitendawili: Ninapiga mbizi, nikiibuka
nina ndevu nyeupe
A. Samaki
B. Mwiko
C. Mvi
D. Mbegu
27. Ni neno lipi lenye irabu pekee?
A. Nyua
B. Miwani
C. Uo
D. Uawa
28. Ukitaka kufanya jambo lichunguze na
ulipime ili ulielewe na ujue
utakachohitaji ili ufaulu. Chagua
methali inayoelezea maelezo
uliyopatiwa
- A. Angeruka juu kipingu hafikii
mbingu
B. Mti hauendi ila kwa nyenzo
C. Gongu gogo ili usikie mlilo wake
D. Usikate mbeleko kabla mwana
hajazaliwa
29. Watu wafuatao husimama kizimbani
ila
A. Wakili
B. Mshtaki
C. Mshtakiwa
D. Shahidi
30. Ni sentensi gani inayoonyesha kuwa
kitendo kimetendeka na kukamilika
vizuri
A. Baba alimuoza bintiye
B. Juma na Maria wanakimbiana
C. Shamba lililimwa likalimika
D. Somo lilisomwa lote

Soma kifungu kifuatacho kisha ujibu maswali 31- 40

Watu wengi huyadhamini mambo ambayo huletwa na wageni sana. Si ajabu kuona mtu akiutupa mbachao wake kwa sababu ya msala wa muda mfupi. Wahenga walilonga kuwa mwacha mila ni mtumwa. Ibura ni kuwa, utumwa mwingine si wa kulazimishwa ila ni wa kujitakia mwenyewe. Idadi kubwa ya watu imeambulia matatizo ya kimwili chungu nzima kutokana na kula vyakula vya kigeni. Vyakula hivi huwa vimesagwa, kutiwa chumvi iliyokolea kupita kiasi na viambato vingine. Fauka ya hayo, baadhi ya vyakula hivyo huwa vimekaa mikebeni muda mrefu kupita kiasi. Matokeo ya kutumia vyakula hivyo huwa ni kuongeza uzito wa mwili na kukosa vitamini za kiasili zinazozuia magonjwa.

Vyombo vya habari humu nchini, hutumia muda mwingi na nafasi kubwa kutangaza na kuvitukuza vyakula vya kigeni. Utayasikia matangazo ya biashara yakitia chumvi kuhusu utamu na wingi wa vyakula vya mikebe. Kwa upande mwingine, wazazi nao hutaka kuwadekeza watoto wao kwa kuwanunulia mapochopocho ya kujaza tumbo bila kuzingatia kiasi cha sukari, mafuta na chumvi iliyomo kwenye vitamu hivi. Wengi wao hudai kuwa wanawaonyesha watoto wao mapenzi. Hatima ya mapenzi hayo ni kukutana na watoto wachanga wasioweza kutembea kwa miguu wala

kukimbia. Ikizidi, huenda wakaanza matibabu ya magonjwa ya moyo/ shinikizo la damu na mengineyo katika umri mchanga sana.

Katika nchi yetu kuna viazi vya kiasili kama vile muhogo, yugwa na viazi vitamu. Vyakula hivi huwa na wanga wa kutosha kuupa mwili nguvu. Isitoshe, kuna wimbi, mtama, shayiri na nafaka zingine tamu tamu ambazo hazina kemikali za kuhifadhi. Mboga za kienyeji kama kunde, mchicha, mgagani na zingine huwa na vitamini kochokocho ambazo watu wa kisasa huzitafuta katika mbukwini ndogondogo zilizotengenezwa kwa kemikali. Vyakula vya kienyeji ni vyakula ambavyo vimetumiwa tangu enzi za mababu zetu. Wao hawakupigana na baadhi ya magonjwa tulio nayo sasa. Mtindo wetu wa kuzembea ambao tumeiga kutoka kwa wageni umetugandisha miili ikawa dhaifu na isiyo na kinga.

Chukua mfano wa muwa. Muwa husaidia misuli ya kinywa kufanya mazoezi ya kutafuna licha ya kusaficha meno. Siku hizi kuna baadhi ya watu wapendao kumeza tu, bila kutafuna. Wao huyashurutisha matumbo yao kuyeyusha na kukisaga chakula chote na hatimaye mashine za tumbo huchoka na kustaafu mapema.

Maafisa wengine huamka asubuhi wakaoga kwa maji moto yaliyochemshwa kwa stima. Shoti wavishwe na mashine watumishi wao huwafungulia milango ya nyumba na ya magari. Madereva nao huanza kazi yao hadi watakapowafikisha makazini na kuwafungulia milango ya lifti. Mwishowe watu hawa hushindwa kuinua miguu na hata vidole vyao kumpiga nzi. Haya wanayaita maendeleo.

31. Methali nyingine yenye maana sawa na 'usiache mbachao kwa msala upitao' ni
- A. Usione kwenda mbele kurudi nyuma si kazi
 - B. Kipya kinyemi ingawa kidonda
 - C. Bora yangu siibadili kwa rehani
 - D. Ujasiri si kupigana na akushindaye

32. Neno jingine lenye maana sawa na wahenga ni
- A. Maajuza wa sasa
 - B. Mashaibu
 - C. Wazee wenye hekima
 - D. Wazee wenye hila

33. Idadi kubwa ya watu imeambulia matatizo kutokana na
- A. Kukuza vyakula vya kigeni
 - B. Kutumia vyakula vya kigeni

- C. Kushurutishwa kula vyakula vya kigeni
- D. Kupendekezewa vyakula vya kigeni

34. Vyakula vya kigeni
- A. Huwa vimetiwa chumvi nyingi
 - B. Huongeza afya kwa mwili
 - C. Huwa na vitamini za kiasili
 - D. Huwa si bei ghali

35. Taarifa hii inatueleza waziwazi kuwa wazazi hufanya mambo yafuatayo isipokuwa
- A. Hutaka kujaza matumbo ya watoto
 - B. Huwaonyesha watoto wao mapenzi kupitia mapochopocho
 - C. Huwaengaengwa watoto kwa kuwanunulia mapochopocho

- D. Huzingatia uzuri wa chakula kabla ya kukinunua
36. Afya ya watoto
- Huchangiwa na mapochopocho
 - Hudhuriwa na sukari, chumvi na mafuta yaliyopita kiasi
 - Hutegemea aina ya mapochopocho yanayoliwa
 - Hulindwa na wazazi
37. Athari ya kula sana na kuzembea ni
- Kunenepa na kuwa mgonjwa
 - Kushindwa kutembea
 - Shinikizo la damu na matibabu ya magonjwa ya moyo
 - Huwa mashine za tumbo huchoka na kustaafu mapema
38. Vyakula vya kienyeji vilianza kutumiwa
- Juzijuzi
 - Tangu jadi
 - Wageni walipoviingiza

- D. Wageni walipovipendekeza
39. Haya wanayaita maendeleo! Maneno haya yanaonyesha
- Furaha ya mwandishi katika maendeleo haya
 - Hali ya mwandishi kukereka na maendeleo haya
 - Hali ya mwandishi kuridhishwa na maendeleo haya
 - Hali ya kushangaa na kutokubaliana na maendeleo haya
40. Mihogo, yugwa na viazi vitamu vyote ni
- Vyakula vya kujenga mwili
 - Vyakula vya kuupa mwili nguvu
 - Vyakula vipiganavyo na baadhi ya magonjwa
 - Vyakula vya kuzuia miili kuganda na kuwa dhaifu

Soma taarifa hii kisha ujibu maswali 41-50

Ilikuwa thenashara mamake Taabu alipoenda kubisha chumbani kwa Taabu kumwamsha na kumhimiza ili asichelewe shule. Taabu alikuwa mtoto mvivu mno. Hakuweza kufanya jambo lolote bila kuhimizwa na mamake. Mamake alichoshwa sana na tabia hii ya mwanawe lakini alishindwa na la kufanya. Mamake Taabu alibisha na kubisha lakini wapi! Taabu hakuitika.

Ndani mle chumbani Taabu alizidi kujifunika shuka yake gubigibi akimlaani mamake kama ilivyokuwa desturi yake. "Lo! Siku mpya imeanza, huyo mwanamke amekwisha nisimamia kama nduli kutaka kunitoa roho yangu. Kwani ni lazima kwenda shule?"

Alipoona mamake anaweza hata kuuvunja ule mlango Taabu aliamua kujikokota kama kwamba ana ndwele fulani hadi bafuni. Alitamani kama angeweza kuyaziba masikio yake ili asiyasikie "rabsha" ya mamake. Aliona mamake anamwonea akatamani ardhi ipasuke aingie ndani. Basi Taabu bila ya kumsabahi ninake alimpita kama gari na kujifungia bafuni. Huko hakuitoa bwagabwaga ili aoge lakini aliitandika ile shuka yake na kujaribu kulala tena

Kwa kweli, Taabu ni mtoto aliyekosa nidhamu kabisa kama angekuwa mtoto mwenye staha njema angekuwa tayari kufanya mambo yake bila ya kufuatwafuatwa na mamake. Tabia hii ya uvivu wa shule, ujeuri na kutosabahi wazazi ilimnyonga mamake Taabu ikampokonya ule uso wake wa tabasamu.

Inatakiwa watoto tujaribu kuwaridhisha na kuwaheshimu wazazi wetu. Tabia kama ya Taabu lazima tuilaani kabisa. Mamake alimlea miezi tisa tumboni. Alipozaliwa akahudumiwa hatimaye amekuwa mkubwa, sasa anajifanya mke wa kujibizana na kumbeza mamake?

41. Kwa nini mamake Taabu aliamua kwenda kumwamsha mwanawe?
 - A. Ili amkaripie sababu ya ulegevu wake
 - B. Kwa sababu kulikuwa kumekucha kitambo
 - C. Ili asichelewe shuleni
 - D. Alitaka asaidiwe kazi za nyumbani
42. Ndani mle chumbani Taabu alijifunika gubigubi... Maanake ni
 - A. Alijifunika kabisa
 - B. Alijifunika mwili wote isipokuwa kichwa tu
 - C. Alijifunika miguu yote
 - D. Alijifunika akawacha mahali padogo pa kupitia pumzi
43. Jambo gani lililomshangaza Taabu?
 - A. Tabia ya mamake
 - B. Vile mamake alivyotaka kujifanya nduli
 - C. Kama ilikuwa lazima kwenda shule
 - D. Kama watoto wote walisumbuliwa na mama zao kama yeye.
44. Taabu aliamka
 - A. Alipomhurumia mamake
 - B. Alipoona kwamba mamake angeuvunja mlango
 - C. Alipoona ni heri aende kulala hamamuni
 - D. Aliposikia makelele ya mamake yamezidi
45. Badala ya neno 'kumsabahi' tunaweza kusema
 - A. Kumwamkia
 - B. Kumuangalia
 - C. Kumuomba radhi
 - D. Kumtukana
46. Mtoto mwenye nidhamu
 - A. Hujaribu kuwaridhisha wazazi wake pekee ili wasikasirike
 - B. Hazisahau mila zake
 - C. Huheshimu jamii nzima na hufanya mambo yake bila kuhimizwa
 - D. Huamka alfajiri
47. Ni zawadi gani tuwape wazazi ili kuonyesha kwamba tunawashukuru kwa malezi yao
 - A. Tuwanunulie zawadi tele
 - B. Tuwatii
 - C. Tuwasalimie kila asubuhi
 - D. Tuwasaidie kuweka heshima

48. Jina lingine la 'nduli' ni

- A. Kitoa roho
- B. Shetani
- C. Zimwi
- D. Dhalimu

49. Neno gani lingetumika badala ya kumbeza?

- A. Kumzushia
- B. Kumjibu vibaya
- C. Kumdharau
- D. Kumkemea

50. Ni sentensi ipi haina ukweli kulingana na taarifa hii?

- A. Taabu alionyesha utovu wa nidhamu alipojibizana na mamake
- B. Mwandishi analaani uvivu na ujeuri
- C. Taabu ni msichana bado mwanafunzi
- D. Mwandishi anatumia tabasamu ya mamake Taabu ilivyopotea

KIRINYAGA COUNTY MOCKS

2014.

MATHEMATICS

STD 8

TIME 2HRS

READ THESE INSTRUCTIONS CAREFULLY

1. You have been given this booklet and a separate answer sheet. The question booklet contains 50 questions.
2. Do any necessary rough work in this booklet
When you have chosen your answer, mark it on the Answer sheet, not in this question booklet.

HOW TO USE THE ANSWER SHEET

4. Use only an ordinary pencil.
5. Make sure that you have written on the answer sheet:

YOUR INDEX NUMBER

YOUR NAME

NAME OF YOUR SCHOOL

6. By drawing a dark line inside the correct numbered boxes mark your full Index Number (i.e School Code Number and the three -figure Candidate's number) in the grid near the top of the answer sheet.
7. Do not make any marks outside the boxes.
8. Keep the sheets as clean as possible and do not fold it
9. For each of the questions 1-50 four answers are given. The answers are lettered A, B, C and D. In each case only ONE of the four answers is correct. Choose the correct answer.
On the answer sheet the answer is to be shown by drawing a dark line inside the box in which the letter you have chosen is written.

Example

In the Question Booklet:

9. What 7999580 rounded off to the nearest ten thousands
A. 7,000,000 B. 8,000,000 C. 799,000 D. 800,000

The correct answer is B.

On the answer sheet:

9. [A.] [B.] [C.] [D]

In the set of boxes numbered 9, the box with the letter B printed in it is marked.

11. Your dark line **MUST** be within the box.
12. For each question **ONLY ONE** box is to be marked in each set of four boxes.

Turn over

1. What is nine hundred and nine thousand and nine hundredths in symbols?
 - A. 900 009.09
 - B. 909 000.09
 - C. 900 000.900
 - D. 909 000.900
2. What is the total value of digit 8 in the number 367820914?
 - A. Hundred thousand
 - B. Eight hundred thousand
 - C. 80000
 - D. 8000000
3. What is the LCM of 30, 45 and 60?
 - A. 15
 - B. 180
 - C. 120
 - D. 360
4. Which of the following fractions has the least value $\frac{15}{16}, \frac{7}{8}, \frac{23}{24}, \frac{5}{6}$?
 - A. $\frac{23}{24}$
 - B. $\frac{7}{8}$
 - C. $\frac{5}{6}$
 - D. $\frac{15}{16}$
5. Mr. Wamalwa planted flowers round his rectangular plot of land 190m long by 110m wide at intervals of 5m leaving a gate of 10m. How many flowers did he plant?
 - A. 120
 - B. 121
 - C. 118
 - D. 119
6. Find the value of m in

$$\frac{2}{2m+1} = \frac{4}{m+8}$$
 - A. $m = 20$
 - B. $m = 6$
 - C. $m = 2$
 - D. $m = 4$
7. The ratio of cows to goats in a farm is 3:2 while that of goat to sheep is 4:5. If there are 24 goats how many animals are there altogether?
 - A. 90 animals
 - B. 48 animals
 - C. 36 animals
 - D. 72 animals
8. A rectangular tank measuring 2.4m by 1.8m by 1.5m high is half full of water. Water is pumped into the tank at a rate of 18 litres per minute. How long will it take for the tank to be full?
 - A. 6hrs
 - B. 3hrs
 - C. 360mins
 - D. 6480
9. Three bells are set to ring at intervals of 20mins, 45mins and 1hr. They all rung together 7:00a.m. At what time will they ring together for the second time in 24hr system?
 - A. 180mins
 - B. 10.00a.m.
 - C. 1000hrs
 - D. 13000hrs
10. What is the value of:

$$\frac{1}{2} + \frac{3}{4} \text{ of } \frac{1}{3} + (1 \frac{1}{2} \div 6) =$$
 - A. $4\frac{1}{3}$
 - B. 1
 - C. $4\frac{3}{4}$
 - D. $1\frac{1}{2}$

11. Mulenge bought the following items from a shop:

4kg of rice @ sh. 80 per kg

3kg of meat for sh. 270

$\frac{1}{2}$ kg of cooking fat at sh. 80 per kilo

He cleared the bill using two – sh. 500 notes. How much did he get back as the balance?

- A. sh. 630
- B. sh. 370
- C. sh. 390
- D. sh. 140

12. What is the value of:

$$\sqrt{\frac{1}{2} \text{ of } 16 \div 4 \times 18}$$

- A. 12
- B. 3
- C. 36
- D. 6

13. What is the value of:

$$\frac{2.5 \times 4 + 3.4 \times 0.8 + 2.48}{8.4 \div 2.1}$$

- A. 0.38
- B. 0.038
- C. 3.8
- D. 38

14. The table below shows timetable used by a train between various towns. Use it to answer the question that follows:-

Town	Arrival time	Departure time
Mombasa	-	0630 hrs
Voi	0750 hrs	0800 hrs
Nairobi	0845 hrs	0855 hrs
Naivasha	0930 hrs	0940 hrs
Kericho	1020 hrs	1045 hrs
Eldoret	1145 hrs	1215 hrs

From Kericho to Eldoret is 120km. Find the average speed for the train between Kericho and Eldoret?

- A. 80 km/h
- B. 90 km/h
- C. 120 km/h
- D. 60 km/h

15. Arrange the numbers 6.0543, 6.5043, 6.0435 and 6.3405 from the smallest to the largest.

- A. 6.0435, 6.0543, 6.3405, 6.5043
- B. 6.0435, 6.3405, 6.5043, 6.0543
- C. 6.5043, 6.3405, 6.0543, 6.0435
- D. 6.5043, 6.0534, 6.0435, 6.3405

16. Calculate the area of the shaded region.

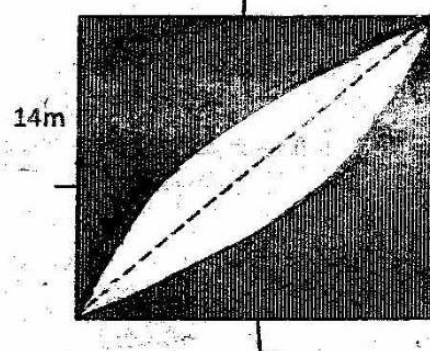

- A. $196m^2$
- B. $112m^2$
- C. $84m^2$
- D. $56m^2$

17. A car travelled 216km at an average speed of 48km/h. On the return journey the average speed increased to 72km/h. Calculate the average speed in km/h for the whole journey.

- A. 57.6
- B. 60

- C. 28.8
D. 68.6

18. Kinyua bought carrots, apples and mangoes for sh. 88. The cost of carrots and apples was sh.64. The cost of apples and mangoes was sh. 52. What was the cost of the apples?

- A. sh. 28
B. sh. 36
C. sh. 40
D. sh. 24

19. A father is five times as old as her son. In 18 years time, he will be twice as old as his son. How old is the father now?

- A. 16yrs
B. 46yrs
C. 36yrs
D. 30yrs

20. The area of a square farm is 16 hectares. Calculate its perimeter in meters

- A. 640 m
B. 400 m
C. 1600 m
D. 800 m

21. A road roller has a diameter of 84cm and it is 50cm wide. Find the area of the road roller in square metres during 200 revolutions of the roller.

- A. 4200cm^2
B. 6600m^2
C. 264m^2
D. 2840m^2

22. What is the value of:

$$\frac{4y + (x - n)}{x + y}$$

When $n = 6$, $x = n + 2$ and $y = \frac{1}{2}x + 1$

- A. $1\frac{9}{13}$
B. $1\frac{1}{2}$
C. $4\frac{1}{2}$
D. $3\frac{1}{4}$

23. Using ruler and a pair of compasses only, construct rectangle PQRS such that $PQ=7\text{cm}$, $QR=5\text{cm}$ and $PR = 5 \text{ cm}$. Draw a circle touching the vertices of the rectangle. Measure the radius of the circle.

- A. 3.5 cm
B. 7 cm
C. 6.2 cm
D. 4.2 cm

24. A sales girl is paid a basic salary of sh. 10000. She is also given 2% commission on the sale of goods above sh. 20000. In one month she was paid a total of sh. 18000. What was the value of goods sold?

- A. sh. 400000 B. sh. 480000
C. sh. 420000 D. sh. 460000

25. A cow was tethered at a corner of a square plot of land 40m long. The rope was 14m long. Calculate the distance round the area the cow grazed.



- A. 22m
B. 160m
C. 96m
D. 50m

26. Adhoc wall clock gains 5 seconds every hour. It was set right on Sunday 11.48a.m. What time will it show the following Sunday at 11:48a.m.?

- A. 12.02a.m.
- B. 12.02p.m.
- C. 11.55p.m.
- D. 11.55a.m.

27. Rono packed 7.5 tonnes of tea leaves in 150 grams packets. How many packets did he obtain
- A. 50
 - B. 3000
 - C. 1125
 - D. 50000

28. Calculate the surface area of the metal rod below: The diameter = 14cm

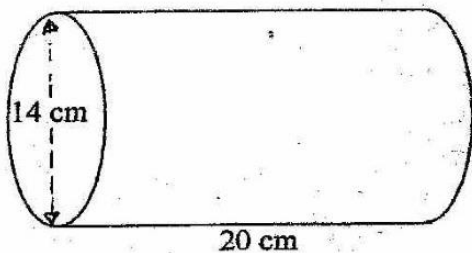

- A. 748cm^2
 - B. 594cm^2
 - C. 1232cm^2
 - D. 1188cm^2
29. The figure below is a wedge. Find its volume:

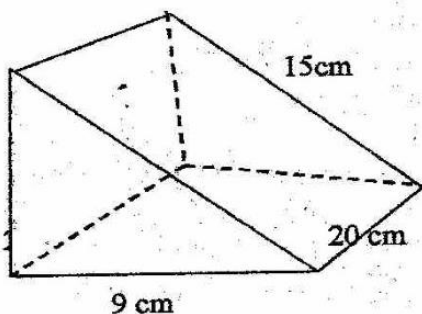

- A. 480cm^3
- B. 1200cm^3
- C. 1080cm^3
- D. 240cm^3

30. Construct a parallelogram ABCD such that $AB=6\text{cm}$, $BC=4\text{cm}$ and angle $ABC=70^\circ$. Drop a perpendicular line from point C to meet line AB at X. Join XD. What is the measure of angle CXD?
- A. 58°
 - B. 100°
 - C. 28°
 - D. 122°

31. The hire purchase price of a Microwave is a deposit of ksh. 2600 and 8 equal monthly instalments of sh. 800. The cash price of the same microwave is 20% less than the hire purchase price. How much is the cash price?
- A. sh. 10800
 - B. sh. 9000
 - C. sh. 7500
 - D. sh. 7200

32. The table below shows the commission charged for sending money upto a maximum of sh. 5000. Use it to answer question that follows:-

Value of order	Commission
Not exceeding sh. 500	Sh. 50
Sh. 501 – sh. 1000	Sh. 100
Sh. 1001 – sh. 1500	Sh. 150
Sh. 1501 – sh. 2000	Sh. 200
Sh. 2001 – sh. 3000	Sh. 250
Sh. 3001 – sh. 4000	Sh. 300
Sh. 4001 – sh. 5000	Sh. 400

David sent sh. 1600 to his wife and sh. 2500 to his brother. How much commission was he charged to send the money?

- A. sh. 200
- B. sh. 450
- C. sh. 4100
- D. sh. 4550

33. In a church there were 80 children and 210 adults. Each of them got 15 biscuits and a bottle of soda. If the biscuits had been packed in cartons consisting of 300 biscuits, how many biscuits remained in the last carton?

- A. 14
- B. 150
- C. 15
- D. 120

34. Grace bought a radio for sh. 16800. She later sold it to Prudence making a loss of 20%, who later sold it making a profit of 5%. How much did Prudence gain by selling the radio?

- A. sh. 14112
- B. sh. 12800
- C. sh. 15600
- D. sh. 672

35. The ratio xy is 3:4 while yz is 3:5. What is the ratio $xy:z$

- A. 3 : 4 : 5
- B. 9 : 12 : 20
- C. 12 : 16 : 18
- D. 2 : 3 : 5

36. The diagram below represents three rectangular block piled together.

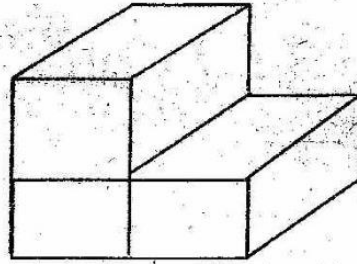

How many faces of the blocks are not in contact with each other?

- A. 4
- B. 5
- C. 6
- D. 2

37. A rectangular container whose base measures 70cm by 60cm is 35cm high. If the container is filled with water to height of 22cm. What is the volume of remaining empty space?

- A. $147,000\text{cm}^3$
- B. $92,400\text{cm}^3$
- C. $54,600\text{cm}^3$
- D. $100,800\text{cm}^3$

38. Lucia operated a kiosk selling potato chips. One day she bought 2 bags of potatoes for sh. 600 each, cooking oil for sh. 360; charcoal for sh. 300 and water for sh. 200. She sold 300 plates of potato chips at sh. 20 per plate. She then paid her 2 helpers sh. 400 each. How much profit did she make?

- A. sh. 2860
- B. sh. 6000
- C. sh. 3140
- D. sh. 1380

39. Elias and John drove from Nairobi to Kerugoya a distance of 480km. They started the journey at 8.00a.m. Elias drove at a constant speed and reached Kerugoya

at 2.00p.m. John drove at a constant speed of 60km/h. How far from Kerugoya was John when Elias arrived?

- A. 480km
- B. 120km
- C. 360km
- D. 180km

40. Samuel went to the shamba at 6.30 a.m. He worked for 3hours 45min before a break of 30minutes. He continued to work until 12.45p.m. when he went for one hour lunch. He continued to work until 4.30p.m. For how long was he working in the shamba?
- A. 7h 40min
 - B. 11h 30min
 - C. 7h 30min
 - D. 8h 30min

41. In the figure below $AB = BC = CD$. Angle $ABC = 72^\circ$. What is the size of Angle BDE?

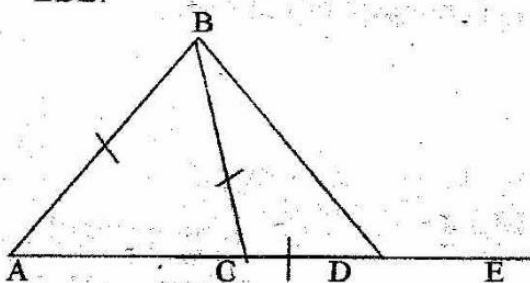

- A. 27°
 - B. 153°
 - C. 63°
 - D. 117°
42. In the year 2013, 14th February was Thursday. What day will be 1st May the same year?
- A. Wednesday
 - B. Thursday
 - C. Tuesday
 - D. Sunday

43. The total length of edges of a square prism is 108cm. Calculate the surface area of the prism:

- A. 9cm^2
- B. 486cm^2
- C. 316cm^2
- D. 484.5cm^2

44. Precious had the following notes in her savings box:

Value of note in shillings	10	20	50	100
Number of notes	14	35	24	8

She changed all that money into sh. 40 coins. How many notes did she get altogether?

- A. 2840 coins
 - B. 72 coins
 - C. 248 coins
 - D. 71 coins
45. The distance between Nairobi and Thika is 50km. On a map a line 5cm is used to represent the distance. Find the scale used:
- A. 1:1000
 - B. 1:10000
 - C. 1:100000
 - D. 1:1000000

46. The mean of six numbers is $4\frac{2}{3}$. Five of these numbers are 5, 3, 7, 8 and 3. What is the median of the six numbers?

- A. 5
- B. 4
- C. 3
- D. 2

47. What is the value of $0.41128 \div 0.3$ correct to three decimal places:

- A. 1.370
- B. 1.371
- C. 1.37
- D. 0.137

48. Cylindrical tins have a diameter of 30cm and a height of 40cm. 5 tins can be placed standing upright along the length and 4 tins along the width of a rectangular carton. Altogether 40 tins were placed in the carton. What is the size of the carton?
- A. 150cm x 120cm x 80cm
 - B. 140cm x 120cm x 60cm
 - C. 150cm x 100cm x 60cm
 - D. 180cm x 150cm x 80cm

49. Muguka deposited sh. 12000 in a bank that gave compound interest at the rate of 10% per annum. At the end of 1 ½ years he withdrew all his money. How much did he withdraw?
- A. sh. 138600
 - B. sh. 18600
 - C. sh. 128600
 - D. sh. 13860

50. What is the next shape in the pattern below?

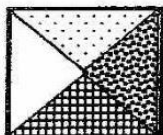
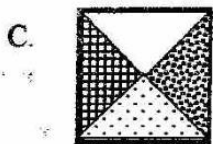
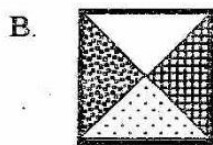
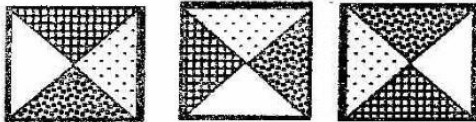

KIRINYAGA COUNTY MOCKS

2014 STD 8

MARKING SCHEME

8

<u>MATHS</u>		<u>ENG</u>		<u>KISWA</u>		<u>SCI</u>		<u>SOCIAL S/C.R.E</u>		
1. B	26. B	1. A	26. A	1. C	26. B	1. D	26. B	1. A	31. C	61. C
2. B	27. D	2. B	27. D	2. B	27. C	2. B	27. C	2. D	32. D	62. A
3. B	28. D	3. B	28. A	3. C	28. C	3. A	28. A	3. B	33. D	63. D
4. C	29. C	4. A	29. D	4. A	29. A	4. C	29. C	4. C	34. C	64. D
5. D	30. A	5. D	30. C	5. B	30. C	5. A	30. D	5. B	35. D	65. D
6. C	31. D	6. B	31. A	6. C	31. A	6. B	31. A	6. C	36. B	66. B
7. D	32. B	7. B	32. C	7. A	32. C	7. C	32. C	7. B	37. D	67. D
8. B	33. B	8. D	33. C	8. B	33. B	8. B	33. B	8. A	38. A	68. A
9. D	34. D	9. C	34. B	9. C	34. A	9. D	34. A	9. B	39. C	69. B
10. B	35. B	10. C	35. A	10. C	35. D	10. C	35. C	10. C	40. B	70. B
11. B	36. D	11. A	36. B	11. C	36. C	11. A	36. B	11. B	41. D	71. A
12. D	37. C	12. B	37. C	12. B	37. A	12. B	37. B	12. B	42. C	72. C
13. C	38. C	13. A	38. C	13. C	38. B	13. B	38. A	13. B	43. B	73. A
14. C	39. B	14. C	39. C	14. B	39. D	14. C	39. D	14. D	44. D	74. B
15. A	40. D	15. D	40. A	15. B	40. B	15. C	40. B	15. C	45. D	75. D
16. B	41. B	16. A	41. D	16. A	41. C	16. C	41. B	16. D	46. C	76. B
17. A	42. B	17. D	42. B	17. C	42. A	17. D	42. B	17. B	47. B	77. B
18. A	43. B	18. C	43. C	18. C	43. C	18. C	43. C	18. A	48. B	78. C
19. C	44. D	19. D	44. C	19. D	44. D	19. D	44. B	19. D	49. C	79. A
20. C	45. D	20. A	45. B	20. B	45. A	20. B	45. D	20. C	50. A	80. D
21. C	46. B	21. A	46. B	21. B	46. C	21. C	46. B	21. D	51. A	81. C
22. A	47. B	22. B	47. D	22. B	47. B	22. B	47. C	22. C	52. C	82. D
23. A	48. A	23. B	48. A	23. D	48. C	23. A	48. A	23. B	53. A	83. D
24. C	49. D	24. B	49. D	24. D	49. C	24. D	49. A	24. D	54. C	84. C
25. A	50. B	25. C	50. B	25. B	50. A	25. D	50. A	25. D	55. A	85. D
								26. C	56. A	86. D
								27. B	57. C	87. C
								28. D	58. D	88. D
								29. D	59. D	89. C
								30. A	60. B	90. A

COMPOSITION/INSHA MARKING SCHEME

MARKING CRITERION

- The Composition will be assessed according to the following general guidelines.
 - The maximum mark will be 40 and minimum mark 01
 - Does the script show that the candidate can communicate accurately, fluently and imaginatively in English.

Accuracy (16 marks)

- | | |
|--|--|
| (a) Correct tense and agreement of verbs (4 mks) | (b) Accurate use of vocabulary (4 marks) |
| (c) Correct spelling (4 marks) | (d) Correct punctuation (4 marks) |

Fluency (16 marks)

- | | |
|---|--|
| (a) Work in the correct order (4 marks) | (b) Sentences connected and paragraphs (4 marks) |
| (c) Correct spelling (4 marks) | (d) Ideas developed in logic sequence (4 marks) |

Imagination (8 marks)

- | |
|--|
| (a) Unusual but appropriate use of words and phrases (4 marks) |
| (b) Variety of structure (4 marks) |

KIRINYAGA COUNTY MOCKS

SCIENCE

STD 8

2014

TIME: 1 HR 40 MINS

READ THESE INSTRUCTIONS CAREFULLY

1. You have been given this booklet and a separate answer sheet. The question booklet contains 50 questions.
2. Do any necessary rough work in this booklet

When you have chosen your answer, mark it on the Answer sheet, not in this question booklet.

HOW TO USE THE ANSWER SHEET

4. Use only an ordinary pencil.
5. Make sure that you have written on the answer sheet:

YOUR INDEX NUMBER

YOUR NAME

NAME OF YOUR SCHOOL

6. By drawing a dark line inside the correct numbered boxes mark your full Index Number (i.e. School Code Number and the three-figure Candidate's number) in the grid near the top of the answer sheet.
7. Do not make any marks outside the boxes.
8. Keep the sheets as clean as possible and do not fold it
9. For each of the questions 1-50 four answers are given. The answers are lettered A, B, C and D. In each case only ONE of the four answers is correct. Choose the correct answer.
On the answer sheet the answer is to be shown by drawing a dark line inside the box in which the letter you have chosen is written.

Example

In the Question Booklet:

9. Which of the following components of blood is involved in clotting after injury?

A. plasma B. white blood cell C. red blood cell D. platelets

The correct answer is D

On the answer sheet

9. [A.] [B.] [C.] [~~D.~~]

In the set of boxes numbered 9, the box with the letter D printed in it is marked.

11. Your dark line **MUST** be within the box.
12. For each question **ONLY ONE** box is to be marked in each set of four boxes.

- In which case below of water conservation is recycling?
 - Repairing broken taps and pipes
 - Trapping water from the roofs into the tank
 - Cleaning bag with bathing water
 - Treating sewage water to become suitable for use again

- Which planets the brightest and hottest among other planets?
 - Mercury
 - Venus
 - Saturn
 - Mars

- Which factor about single fixed pulley is NOT TRUE?
 - The load distance is twice the effort distance
 - The load moves opposite direction with effort
 - Makes the work convenient
 - Makes work easier by changing the direction of the force

- Use the diagram below to answer question 4

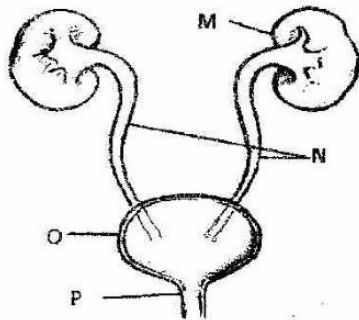

Which are the correct names of the part marked P, O, M and N respectively

- | P | O | M | N |
|------------|---------|---------|---------|
| A. kidney | ureter | bladder | urethra |
| B. bladder | urethra | kidney | bladder |
| C. urethra | bladder | kidney | ureter |
| D. Urethra | ureter | bladder | kidney |

- Which one the following is an industrial use of water?
 - Generation of electricity
 - Rearing of fish
 - Watering plants
 - Washing utensils

- Which one of the following infant diseases is immunized against only at birth?

A. BCG	C. Tetanus
B. Polio	D. Tuberculosis

- The diagram below shows a method of controlling soil erosion

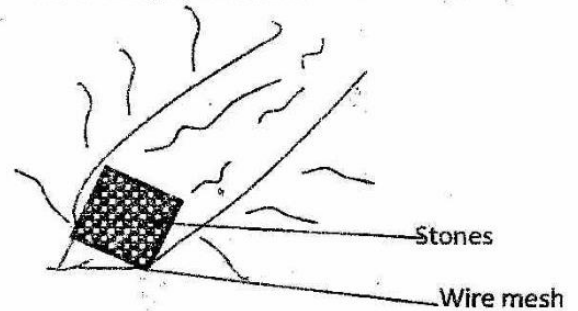

Which one of the following statements is NOT TRUE about the above method

- It is the method used for controlling erosion that takes place on a steep slope.
 - It is also called porous dam
 - It can be used for controlling rill erosion
 - It is an effective way of controlling gulley erosion
- The first set of teeth that grow in the mouth of a child are called by the following names EXCEPT?

A. Deciduous teeth	B. Milk teeth
B. Secondary teeth	D. Primary teeth
 - Which one of the following statements is not true about a periscope?
 - It is used to see what is above the water surface
 - The mirrors are fitted to the horizontal at an angle of 45

- C. It works on the principle of reflection
 D. It bends light as it passes through the water.
10. Which one of the following is not an example of animal feed concentrate?
 A. Sunflower seed cake
 B. Wheat bran
 C. Glycerine
 D. Bone meal
11. Std 5 pupils of Gof Rateng primary school constructed a windvane as shown below

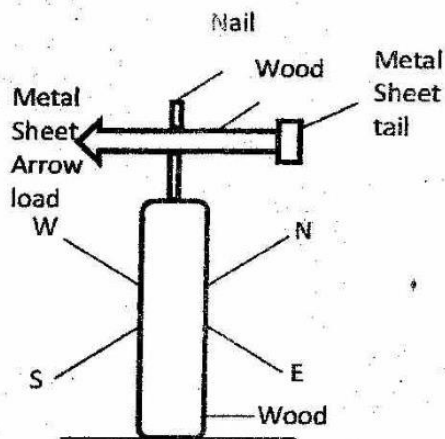

- What mistake did they make when constructing the simple wind vane?
 A. Making the tail smaller than the arrow head
 B. Ignoring geographical directions
 C. Using wood to make the support
 D. Using a nail instead of a string
12. Which is the energy transformation that takes place in the simple electric current when the switch is closed shown below?

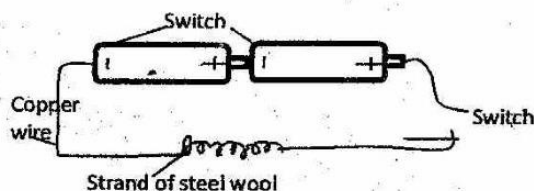

- A. Heat \rightarrow chemical \rightarrow Electrical \rightarrow light
 B. Chemical \rightarrow Electrical \rightarrow heat \rightarrow Light
 C. Chemical \rightarrow electrical \rightarrow light \rightarrow heat

- D. Electrical \rightarrow chemical \rightarrow heat \rightarrow Light

13. The diagram below represents the jaw of a certain animal that was picked by std 8 candidates

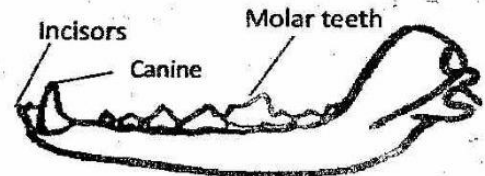

The type of jaw is NOT LIKELY to be found in

- A. Sheep
 B. Donkey
 C. Goats
 D. Cows
14. Which one of the following is NOT an effect of HIV infection on an individual
 A. Lowering self esteem
 B. Lack of strength to play and work
 C. Sadness in the family
 D. Poor performance at the place of work
15. Famyard manure should NOT be exposed to the rains and direct sunlight . This is because?
 A. Circulation of air will be interfered with
 B. To prevent them from changing colour
 C. To prevent them from losing nutrients
 D. To make the decomposer active
16. The following are signs of a certain communicable disease
 i. Chest pain
 ii. Fever
 iii. Pale ,thin and weak body
 iv. Frequent coughs
 The disease described above can be spread through the following ways EXCEPT?
 A. Kissing and sharing personal items
 B. Breathing air carrying the causative agents
 C. By drinking boiled milk from infected cows
 D. By sharing cups and spoon

17. The chart below represents a simple classification of pollutants

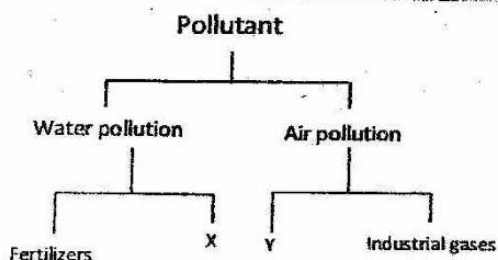

The pollutant represented by X and Y are

- | | |
|--------------------|-------------------|
| X | Y |
| A. Burning tyres | smoking cigarette |
| B. Smoking tobacco | oil spillage |
| C. Human waste | fertilizers |
| D. Acid rain | smoking tobacco |

18. Which of the can be separated using the method of separation illustrated below?

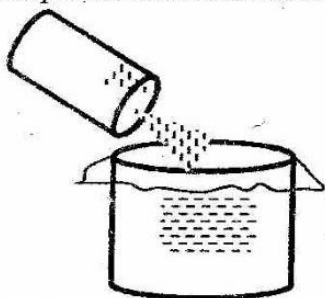

Which pair of substance can be separated using the above method?

- A. Maize and beans
 B. Salt and water
 C. Sand and water
 D. Beans and chaffs
19. Sound travels through solids, liquids and gases. Which one of them will allow sound to travel fastest and slowest respectively?
- A. Solid and liquid
 B. Liquid and gas

- C. Gas and solid
 D. Solid and gas

20. Which one of the following activities depletes the blanket-like layer found between the earth and the sun which protects us from direct rays of the sun?
- A. Cultivating along the slopes
 B. Burning of waste vehicle tyres in an open place
 C. Use of drip irrigation
 D. Release untreated sewage to the environment

21. Which one of the following statements is incorrect about feeding adaptation in birds?
- A. Birds with short, strong sharp, curved beaks feed on flesh
 B. Birds with long slender slightly curved beaks suck nectar
 C. Birds with short straight pointed beak feed on frogs
 D. Birds with flat serrated beaks get their food from water or mud

22. The diagram below represents a certain type of animal parasite. Which one of the following pair of animals is attacked by this parasite?



- A. Cattle and pigs
 B. Poultry and rabbits
 C. Cattle and fish
 D. Goats and poultry

23. A doctor examined a sick child with the following signs

- i. Wrinkled face
 ii. Unhappiness
 iii. Emaciated body

The doctor was to advise the best diet for the child was?

- A. Sufficient diet rich in all nutrients
- B. Enough body building food
- C. Diet rich in iron and proteins
- D. Diet rich in calcium and phosphorous

24. The following are methods of food preservation. Which methods mainly modern?

- A. Use of low temperature
- B. Salting
- C. Sun drying
- D. Canning

25. Which one of the following statements about digestion is NOT TRUE

- A. Pancreas and liver are part of digestive system
- B. Food in form of porridge is emptied from the stomach to the ileum
- C. Colon is part of the alimentary canal
- D. Ileum absorbs digested food, water and mineral salts

26. In a lever force applied to overcome another force is likely to be?

- A. Fulcrum
- B. Effort
- C. Force of gravity
- D. Load

27. The diagram below is a method of making a certain organic manure

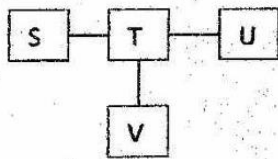

Which type of manure can be prepared by the method above?

- A. Organic mulches
- B. Compound fertilizer
- C. Compost manure
- D. Farm yard manure

28. Std 5 pupils were carrying out an experiment on drainage of the soil. Their science teacher told them to bring the apparatus for the experiment. They brought the following

- i. Wahu – biro pen tubes
- ii. Kivunga – a piece of cotton wool
- iii. Sibi – soil samples
- iv. Kabotia – collecting jar

Who among them brought an item that was not needed

- A. Kabotia
- B. Kivunga
- C. Wahu
- D. Sibi

29. The diagram below shows a flower. Which parts of the flower protect it during bud stage?

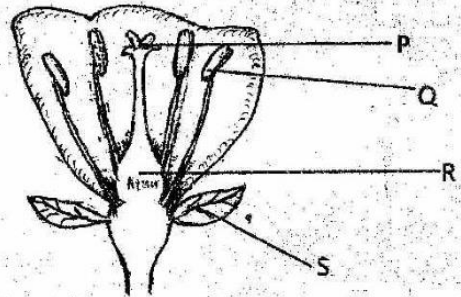

- A. Q
- B. P
- C. S
- D. R

30. Three of the following drugs are obtained from plants.

Which one is NOT entirely made from plants?

- A. Heroin
- B. Bhang
- C. Cocaine
- D. Mandrax

31. Which one of the following substances is NOT likely to be found in the largest and the liquid part of the blood?

- A. Nitrogenous waste
- B. Nutrients
- C. Oxygen
- D. Carbon dioxide

32. Which one of the following statements **IS NOT TRUE** about insectivorous plants?

- A. Traps insects using leaves
- B. Grow in nitrogen – deficient soils
- C. Grow on other living plants
- D. Trap insects in order to make proteins

33. Pupils made fire and placed pieces of papers and dropped them over the burning candle one at a time as shown below

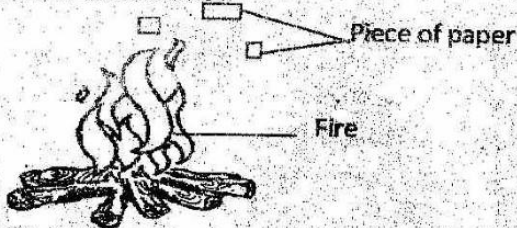

This activity was done to demonstrate the transfer of heat in

- A. Solid
- B. Air
- C. Liquid
- D. Vacuum

34. Which one of the following drugs is **INCORRECTLY** matched with its effects?

Drugs	Effects
A. Alcohol	hallucination
B. Khat	sleeplessness
C. Tobacco	lung cancer
D. Bhang	increased appetites

35. Which one of the following animals feed will provide them with body building food?

- A. Star grass
- B. Maize germ
- C. Desmodium
- D. Napier grass

36. Which of the following factors make feathers to float?

- A. Shape of material
- B. Type of material
- C. Mass of material
- D. Size of material

37. Which one of the following pairs of processes is as a result of reduction in temperature?

- A. Evaporation and melting
- B. Freezing and condensation
- C. Freezing and melting
- D. Evaporation and condensation

38. The following are characteristics of a certain animal

- i. Have backbone
 - ii. Lay unfertilized eggs
 - iii. Body covered with scales
- The animal described above is likely to be?

- A. Shark
- B. Tadpole
- C. Newt
- D. Crocodile

39. The diagram below represents a certain weed. Std 4 pupils observed in the farm

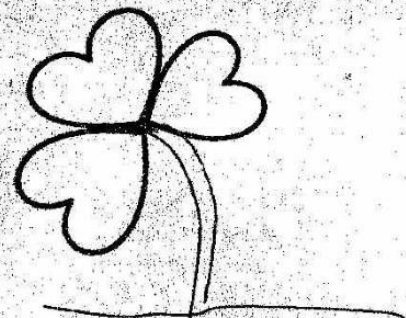

The weed has the following characteristics **EXCEPT**

- A. Grows in the shade
- B. Has lobbed leaves
- C. Produce pink flowers
- D. Produce yellow fruits when ripe and green when raw

40. Which one of the following is **NOT** a sign of ill health in animals

- A. Blood stain in the stool
- B. Wet muzzle
- C. Stunted growth
- D. Frequent coughs

41. Which one of the following form of energy is renewable?

- A. Petrol
- B. Natural gas
- C. Charcoal
- D. Coal

42. Lactating mothers need various types of food. Which of the following gives the reason why they need iron in the diet?

- A. For the formation of strong bones of the baby
- B. To replace the blood the blood lost during birth
- C. To prevent constipation
- D. To make blood for the foetus

43. Which one of the following components of environment are living components?

- A. Air and plants
- B. Water and soil
- C. Plants and animals
- D. Animals and soil

44. Which one of the following activities takes place in the diaphragm when one breathes in

- A. Increase in volume
- B. It flattens
- C. Its pressure increases
- D. It relax

45. The diagram below shows a spring balance. Which aspect cannot be measured using it?

- A. Gravity
- B. Friction
- C. Weight
- D. Inertia



46. Which one of the following is non-magnetic material?

- A. Cobalt
- B. Copper
- C. Steel
- D. Iron

47. Which one of the following terms is NOT correctly matched with its meaning?

- A. Implantation –the attachment of foetus on to the uterine wall
- B. Parturition –the process of giving birth
- C. Placenta – a disc shaped organ that joins the embryo in the uterine wall
- D. Labor pains – the contraction of uterine walls causes it

48. Which one of the following is NOT a crop that provides fibre?

- A. Legume
- B. Sisal
- C. Cotton
- D. Flax

49. Plants depend on each other for all the following reasons. Which one is not?

- A. Medicine
- B. Support
- C. Protection
- D. Habitat

50. Which properties of light is investigated in the experiment below

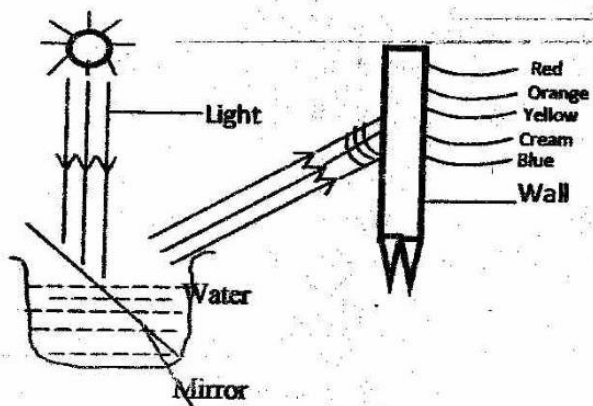

- A. Dispersion
- B. Reflection
- C. Spectrum
- D. Light moves in all directions

KIRINYAGA COUNTY MOCKS

POWERED BY: www.eeducationgroup.com

2014

**SOCIAL STUDIES AND
RELIGIOUS EDUCATION**

STD 8

TIME: 2HRS 15MINS

READ THESE INSTRUCTIONS CAREFULLY

1. You have been given this booklet and a separate answer sheet. The question booklet contains 90 questions.
2. Do any necessary rough work in this booklet

When you have chosen your answer, mark it on the Answer sheet, not in this question booklet.

HOW TO USE THE ANSWER SHEET

4. Use only an ordinary pencil.
5. Make sure that you have written on the answer sheet:

YOUR INDEX NUMBER

YOUR NAME

NAME OF YOUR SCHOOL

6. By drawing a dark line inside the correct numbered boxes mark your full Index Number (i.e School Code Number and the three -figure Candidate's number) in the grid near the top of the answer sheet.
7. Do not make any marks outside the boxes.
8. Keep the sheets as clean as possible and do not fold it
9. For each of the questions 1-50 four answers are given. The answers are lettered A, B, C and D. In each case only ONE of the four answers is correct. Choose the correct answer.

On the answer sheet the answer is to be shown by drawing a dark line inside the box in which the letter you have chosen is written.

Example

In the Question Booklet:

9. Which of the following groups of people belong to a nuclear family?
A. Mother, Son, Grandfather
B. Father, Son, Uncle
C. Father, Daughter, Son
D. Grandmother, Father, Daughter

The correct answer is C.

On the answer sheet:

9. [A]. [B]. [C]. [D]

In the set of boxes numbered 9, the box with the letter C printed in it is marked.

11. Your dark line **MUST** be within the box.
12. For each question **ONLY ONE** box is to be marked in each set of four boxes.

TURN OVER

ORANGE AREA

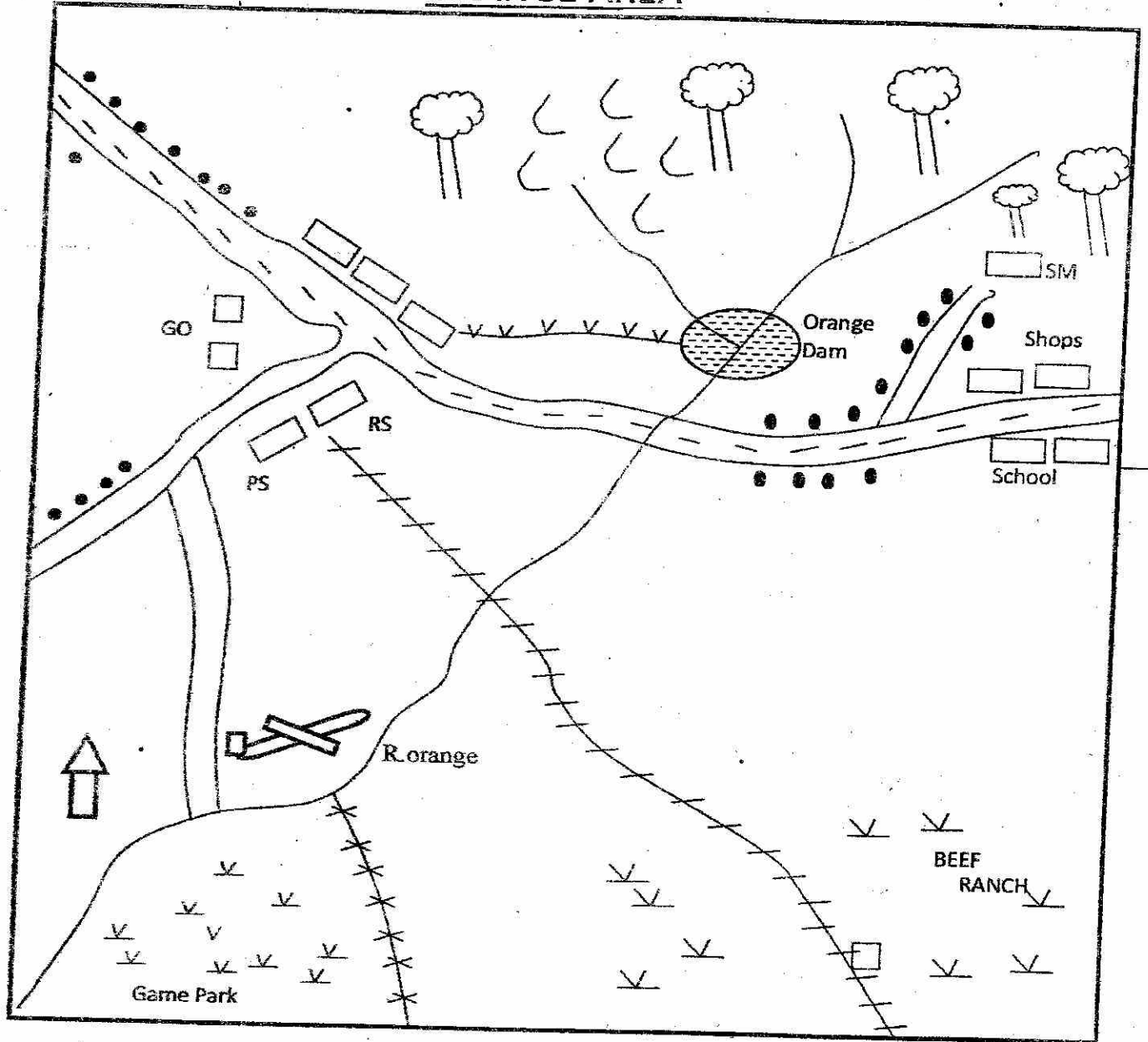

SCALE 0 1 2 3 4 5 6 7 8 9 10 KMS

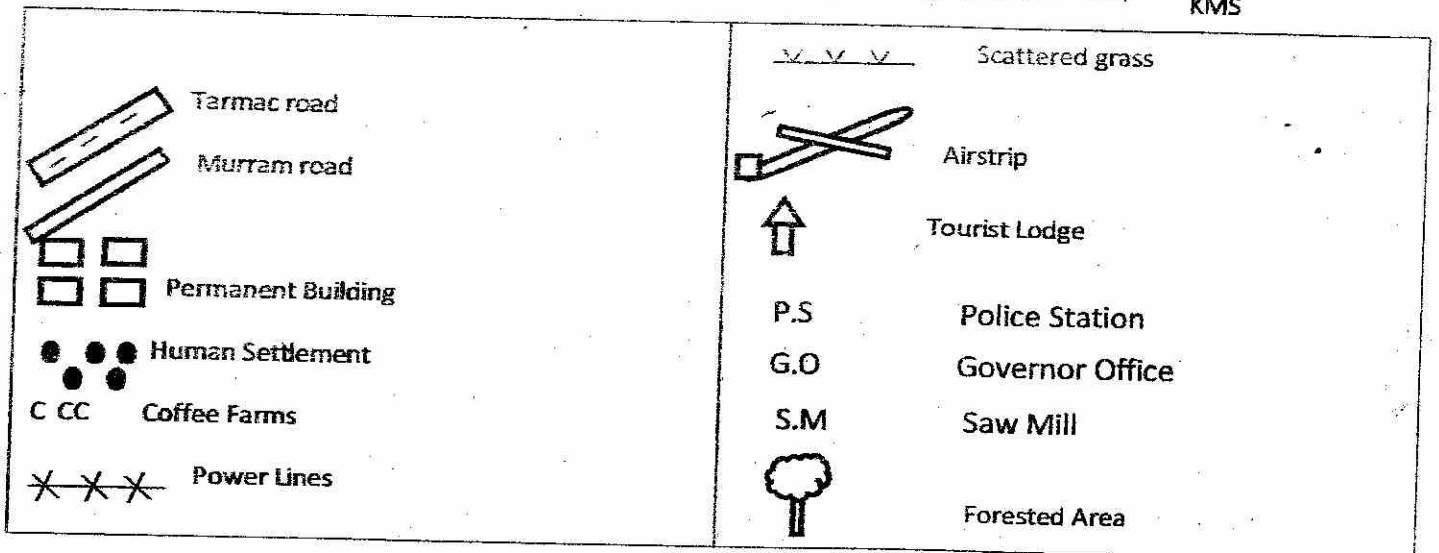

Study the map of Orange area and use it to answer question 1 – 7

1. Which of the following is the main benefit from river Orange project
 - A. Increased industrial development
 - B. Increase food production
 - C. Increase tourist activity
 - D. Controlling floods in lower parts of orange area
2. The main factor that has influenced population distribution in Orange area
 - A. Distribution of industries
 - B. Rainfall reliability
 - C. Vegetation cover
 - D. Transport network
3. Land in orange area rises from
 - A. South East
 - B. South West
 - C. North West
 - D. North East
4. The head of Orange area is elected by
 - A. President
 - B. Voters in the whole country
 - C. Voters in the county
 - D. Members of the county assembly
5. Which of the following items is transported by railway line in the area
 - A. Building stone
 - B. Processed meat
 - C. Soldiers
 - D. Timber

6. The fastest means of transport in the area is likely to be
 - A. Road transport
 - B. Railway transport
 - C. Air transport
 - D. Water transport
7. The climate of the Southern part of the map is likely to be
 - A. Cool and wet
 - B. Hot and dry
 - C. Cool and dry
 - D. Hot and wet
8. The interaction between Mijikenda and Arab before the 19th century led to
 - A. Development of new language
 - B. Development of kingdoms in the area
 - C. Mijikenda acquiring new names from Arab
 - D. Arabs acquiring new names from Mijikenda
9. Which of the following statement about Homo erectus is correct? He
 - A. Walked on four limbs
 - B. Used fire to prepare food
 - C. Ate raw food
 - D. Made iron tools
10. Seyyid Said came to Eastern Africa from Oman before the 19th century to:
 - A. Stop slave trade
 - B. Acquire colonies
 - C. Look for trade items

D. Explore the source of river Nile

11. The hottest month along the coast of South Africa are

- A. July and June
- B. December and January
- C. August and September
- D. March and April

12. Which group consist of crops that can be grown in plantations

- | | | | |
|---|----------------------------------|---|-----------------------------|
| A | Coconut
Potatoes
pyrethrum | B | Sisal
Wheat
sugarcane |
| C | Sorghum
Yams
beans | D | Millet
Kales
cotton |

13. Rural to urban migration can best be controlled by

- A. Establishing more industries in urban centers
- B. Establishing more industries in rural area
- C. Arresting idlers in towns
- D. Improving social facilities in towns

14. Three of the following statements about families living in rural areas is true. Which one is not

- A. It is mainly extended families
- B. Most of the families depend on farming
- C. They are usually large families

D. Most families depend on industrial work

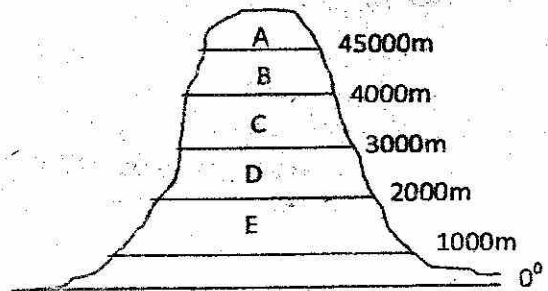

15. Which of the part of mountain Vegetation marked above shows bamboo and rainforest respectively?

- A. D and E
- B. C and B
- C. C and D
- D. B and D

16. Below are descriptions of a certain climate region

- I. hot and humid
- II. vegetation is evergreen
- III. rainfall is high annually
- IV. heavy downpour in the afternoon accompanied with thunder and lightening

The climate region described above is

- A. Mediterranean
- B. warm temperate
- C. tropical savanna
- D. equatorial

17. Which group of the mountains listed below consists of dormant volcanoes

- | | | | |
|---|-------------------------------|---|-----------------------------|
| A | Cameroon
Mfumbiro
Suswa | B | Tibesti
Elgon
Mhavura |
|---|-------------------------------|---|-----------------------------|

C
 Longonot
 Moroto
 Suswa

D
 Oldoinyo lenga
 Ngorongoro
 Nyirangongo

18. A school management committee performs the following duties except one. Which one is it
- A. hiring teachers
 - B. hiring non-teaching staff
 - C. firing non-teaching staff
 - D. approving school development budget

19. The main cause of soil erosion in pastoral area is
- A. Monocropping
 - B. Bench terraces
 - C. Deforestation
 - D. Overstocking

Study the map of Africa below and use it to answer questions 20-24

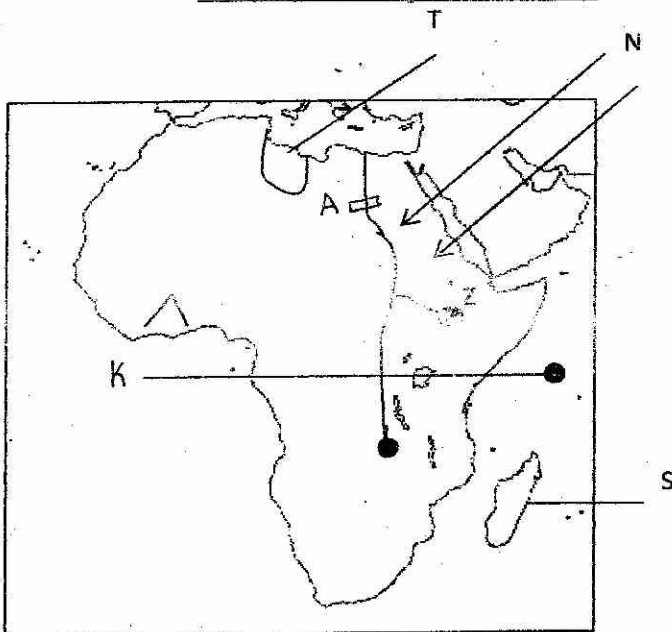

20. The countries marked S and T were colonized by _____ respectively.
- A. Britain and French
 - B. Germany and French
 - C. France and Italians
 - D. Italians and Spain

21. The lake marked Z was formed when
- A. Water collected in a depression
 - B. Water collected in a crater
 - C. Water collected in fault lines
 - D. Water collected behind a lava dammed river

22. The region labeled A is mainly known for
- A. Mining of petrol
 - B. Growing of cocoa
 - C. Production of Hydroelectric power
 - D. Growing of cocoa.

23. Which one of the following statements about the winds marked N is correct? They
- A. Cause dry conditions in area they land
 - B. Bring heavy rainfall in the coastal parts
 - C. Raise temperature in areas they pass through
 - D. Bring fog and mist in adjacent land

24. Which of these countries is not crossed by the line of latitude marked K?
- A. Uganda
 - B. Somalia

- C. Kenya
- D. Tanzania

25. Which one of the following is an example of a pre-historic tourist attraction site in Kenya?
- A. Bomas of Kenya
 - B. Fort Jesus
 - C. Maasai Mara
 - D. Koobi Fora
26. The main source of petroleum in Nigeria is around
- A. Johannesburg
 - B. Nile delta
 - C. Niger delta
 - D. Tana delta
27. In the school democracy is applied when
- A. Appointing Headteachers
 - B. Electing school prefects
 - C. Employing teachers
 - D. Choosing subjects to be taught to class eight pupils
28. When the European settlers occupied the land that was formerly for Africans, the Africans were settled in
- A. White highlands
 - B. Black highlands
 - C. Crown land
 - D. Native reserves

Use the map of Kenya below to answer questions 29 – 32

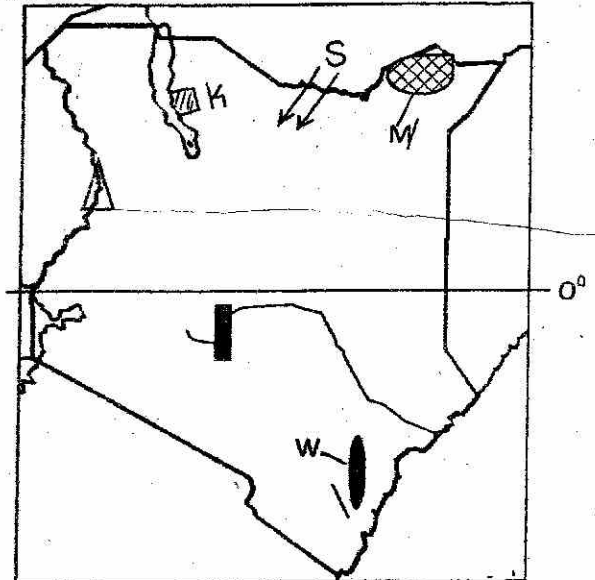

29. The economic activity mainly carried out at the place marked K is
- A. floriculture
 - B. dairy farming
 - C. ranching
 - D. tourism
30. The game park marked M is found in which county?
- A. Mandera
 - B. Wajir
 - C. Marsabit
 - D. Garissa
31. The economic activity carried out by the community that used to route S was
- A. Mining
 - B. Fishing
 - C. Pastoralism
 - D. Farming

32. The forest marked W is a lowland tropical forest. It is likely to be?

- A. Shimba hills forest
- B. Mau forest
- C. Kaptagat forest
- D. Gedi forest

33. Which one of the following is a service industry?

- A. Fruit canning
- B. Vehicle assembling
- C. Cotton ginnery
- D. banking

34. Road transport is commonly used in Eastern Africa mainly because it is

- A. Cheapest
- B. Fastest
- C. Widespread
- D. Safest

35. Jomo Kenyatta supported regional co-operation in Eastern Africa by

- A. Leading Kenya to independence
- B. Writing the book "Facing mount Kenya"
- C. Establishing harambee philosophy
- D. Founding the East African community

36. The African communities were defeated by Europeans colonialists mainly because they

- A. Were not united
- B. Were poorly armed
- C. Were not properly trained
- D. Believed in witchcraft

37. Which one of the following statements about Mombasa city is not true?

- A. Started as a trading center
- B. Has an international airport
- C. Has an oil refinery
- D. It is the main commercial center in Kenya

38. Which one of the following actions can promote peace among different communities in Kenya?

- A. Equitable distribution of national wealth
- B. Cattle rustling among pastoralists
- C. Voting for people from their tribes
- D. Corruption in public institution

39. Which one of the following is the main importance of first aid to an accident victim?

- A. To promote recovery
- B. To prevent further injuries
- C. To save life
- D. To enable victim reach to the hospital

40. Kenyan highlands are mainly densely populated because they

- A. Have many settlement schemes
- B. Have high rainfalls
- C. Have black cotton soils
- D. Have many industries

41. Which one of the following countries is not a member of SADC?

- A. Mozambique
- B. Mauritius
- C. Madagascar

- D. Seychelles
42. The fishing industry is not developed along the Indian ocean coast mainly because of
- A. Poor means of transport
 - B. Inadequate market for fish
 - C. Use of poor fishing methods
 - D. Inadequate storage facilities
43. Which one of the following ways is the best method of conserving forests?
- A. Establishing forest reserves
 - B. Creating awareness on the importance of forests
 - C. Initiating reafforestation programs
 - D. Keeping people away from forests
44. Which one of the following statements is true of the San?
- A. They were ruled by chiefs
 - B. They were ruled by a council of elders
 - C. They were herdsmen
 - D. They made decisions through consensus
45. During the Berlin conference, the European powers agreed the following. Which one:
- A. Areas with chiefs could not be acquired
 - B. Use of assimilation policy
 - C. The whole of Africa was to be under European rule
 - D. Areas could be colonized if they were not occupied
46. Three of the following countries used armed struggle for independence. Which one did not?
- A. Kenya
 - B. Angola
 - C. Tanzania
 - D. Mozambique
47. The most important factor a Jua kali artisan may consider before setting up a Jua kali center is
- A. Nearness to market
 - B. Availability of electricity
 - C. Availability of workers
 - D. Nearness to raw materials
48. Salt is mined in Kenya near
- A. Gilgil
 - B. Mombasa
 - C. Kerio Valley
 - D. Malindi
49. Shifting cultivation was mainly done to:
- A. Prevent soil erosion
 - B. Allow soil regain fertility
 - C. Occupy uncultivated land
 - D. Reduce congestion in an area
50. Which one of the following methods of poultry farming is mainly carried in rural areas?
- A. Battery system
 - B. Fold system
 - C. Deep litter system
 - D. Backyard system

51. Pastoralism is mainly practised in large flat areas because it makes
- Easy movement of animals
 - Quick growth of pastures
 - Easy use of machines
 - Easy location of veterinary service
52. An elected person representing a constituency loses the seat if he or she
- Completes five years
 - Falls sick and admitted in hospital
 - Is declared bankrupt by court of law
 - Misses two consecutive sessions
53. The traditional parliament of Swaziland is known as:
- Liqoqo
 - Libandla
 - Tinkhuudhla
 - Lukiiko
54. Which one of the following is not a reason why people in Kenya should vote in national elections?
- To exercise their democratic rights
 - To elect leaders of their choice
 - To obey the law of Kenya
 - To elect a new government
55. Which one of the following factors has enabled farmers in Netherlands to grow crops throughout the year?
- Availability of polders
 - Well managed co-operative societies

- Well advanced transport sector
 - Extensive use of glass houses
56. Through which ways can a foreigner become a Kenyan citizen?
- Naturalization
 - Nationalization
 - Dual citizenship
 - Registration
57. A document used to record political parties' policies is?
- Hansard
 - Order paper
 - Manifesto
 - Constitution
58. What is the function of the Independent Electoral Boundary Commission (IEBC)
- Nominating members of parliament
 - Appointing senior government officials
 - Registering political parties
 - Registering voters
59. Which one is the main work of Kenya defense force?
- Maintain law and order
 - Punish law breakers
 - Arresting suspected criminals
 - Dealing with external aggressions
60. Below are problems facing poultry farming. Which one is **NOT**?
- Lack of skills and knowledge.
 - Source of income.

C. Low productivity.

D. High cost of feeds

SECTION A

CHRISTIAN RELIGIOUS EDUCATION

61. Despite human disobedience God showed love to Adam and Eve through
- A. Giving them another garden
 - B. Cursing them
 - C. Making clothes for them
 - D. Chasing them completely
62. During the floods, Noah sent which bird first to check the level of floods.
- A. Dove
 - B. Raven
 - C. Sparrow
 - D. Hawk
63. During the call of Moses, God's presence was seen through
- A. Cloud
 - B. Snake
 - C. Sandals
 - D. Burning bush
64. Which one of the following events took place at Meribah?
- A. Israelites complained lack of food
 - B. Joshua set up memorial stone
 - C. Water came from a rock
 - D. Bitter water was cured
65. Jethro the father-in-law of Moses was a priest for?
- A. Israelites
 - B. Moabites
 - C. Ammorites
 - D. Midianites
66. From Hannah's prayer at Shiloh, Christians learn that
- A. Praying loudly is the best
 - B. Persistence in prayer is important
 - C. Praying only at needy times
 - D. Praying silently
67. King Ahab was unfair in his dealing when he:
- A. Murdered Uriah
 - B. Accepted Jezebel to advice him
 - C. Worshiped Baal
 - D. Took Naboth vineyard.
68. Which prophet was used by God to anoint King Solomon as the third king of Israel?
- A. Zadok
 - B. Samuel
 - C. Nathan
 - D. Elijah
69. The Shunamite woman welcomed prophet Elisha into her house by:
- A. Giving him clothes
 - B. Giving him a place to stay
 - C. Washing his clothes
 - D. Pouring oil on his feet
70. The prophet who foretold about the suffering servant is:
- A. Micah
 - B. Isaiah
 - C. Jeremiah

D. Amos

71. When Jesus was presented in the temple for dedication, prophet Simeon described Him as
- A. Light to reveal to the gentiles
 - B. Savior of the Jews
 - C. Lamb of God
 - D. Prince of peace
72. "Do not accuse anyone by false accusation" was the message of John the Baptist to
- A. Pharisees
 - B. Judges
 - C. Soldiers
 - D. Tax collectors
73. "You are my own dear son. I am pleased with you" (Luke 3:22). These words were spoken during the
- A. Baptism of Jesus
 - B. Resurrection of Jesus
 - C. Transfiguration of Jesus
 - D. Birth of Jesus
74. Who among the following disciples did Jesus send to prepare the last supper?
- A. Simon and Andrew
 - B. John and James
 - C. James and Peter
 - D. John and Peter
75. In which one of the following towns did Peter healed Aeneas?
- A. Jerusalem
 - B. Lydda
 - C. Caesarea
 - D. Joppa
76. Which one of the following parables of Jesus teaches Christians the use of our abilities? The parable of the
- A. Mustard seed
 - B. Lost son
 - C. Lost coin
 - D. Gold coin
77. Who among the following people will see God according to the teaching of Jesus in the Sermon on the Mount?
- A. The poor in spirit
 - B. The pure in heart
 - C. The merciful
 - D. The meek
78. Who among the following is not a member of the clergy?
- A. Bishop
 - B. Priest
 - C. Deacon
 - D. Pastors
79. On the day of Pentecost the holy spirit came in form of:
- A. Tongues of fire
 - B. Dove
 - C. Burning bush
 - D. Smoke
80. "You created every part of me, you put me together in my mothers womb". These are words found in the book of:
- A. Matthew
 - B. Proverbs
 - C. Revelation
 - D. Psalms

81. Which one of the following is not a value acquired in education?
- Self-discipline
 - Co-operation
 - Poverty
 - Sharing
82. Who among the following people was advised by Paul to preserve the gift given to him by God?
- Silas
 - Apollos
 - Titus
 - Timothy
83. Which of the following commandments shows respect for other people property?
- Do not covet
 - Do not commit adultery
 - Do not commit murder
 - Do not steal
84. In African traditional societies, people were expected to marry mainly to:
- Be respected
 - Have a partner
 - Get children
 - Avoid loneliness
85. Which one of the following is not a cause of child labour?
- Provide cheap labour
 - Irresponsible parents
 - Parents death
 - To get rich quickly
86. In some African traditional societies, boys and girls were only allowed to mix freely during.
- Dancing
 - Playing
 - Eating
 - Working
87. African traditional believers ask God for rain by:
- Naming children after ancestors
 - Pouring libation to ancestors
 - Offering sacrifices
 - Abstaining from eating
88. The following are sexual pervasions. Which one is not?
- Adultery
 - Fornication
 - Incest
 - Chastity
89. Lily was given excess change by a shopkeeper and then she decided to use the money. Which of the following virtues does she lack?
- Discipline
 - Humility
 - Honesty
 - Courage
90. The main reason why Christians should avoid drug abuse is because
- Our body is the temple of the Lord
 - Drugs make us poor
 - Drugs are all illegal
 - Drugs make us active